

NO.	MASSE / DIMENSION
A	1 1/2-18NEF-2A
B	20.6
C	4
D	34.2
E	35.3
F	34.9
G	44.5
H	3.7

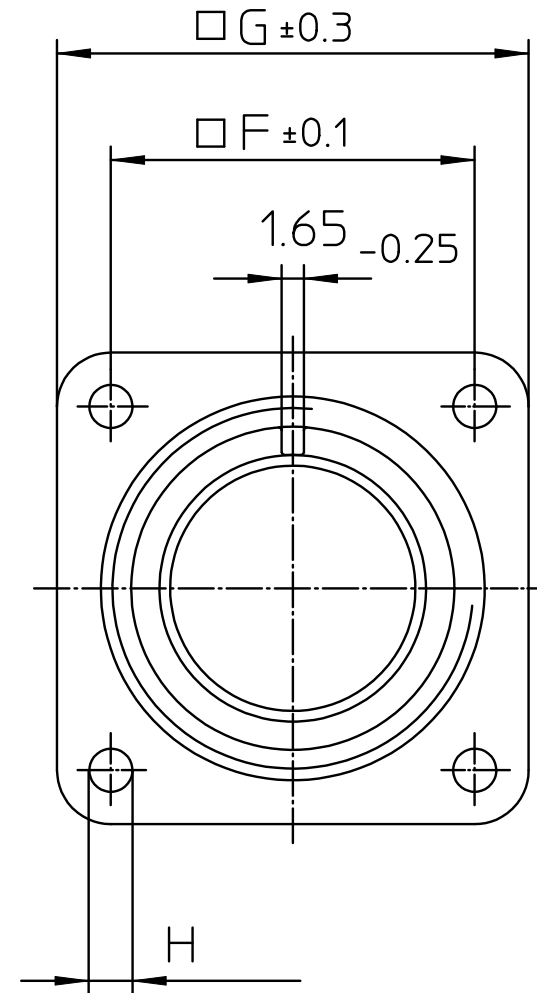

NO.	BESCHREIBUNG / DESCRIPTION
2	ISOLIERKÖRPER BUCHSE / INSULATOR SOCKET
6	KONTAKTBUCHSE / CONTACT SOCKET
8	DOSENGEHÄUSE / SHELL

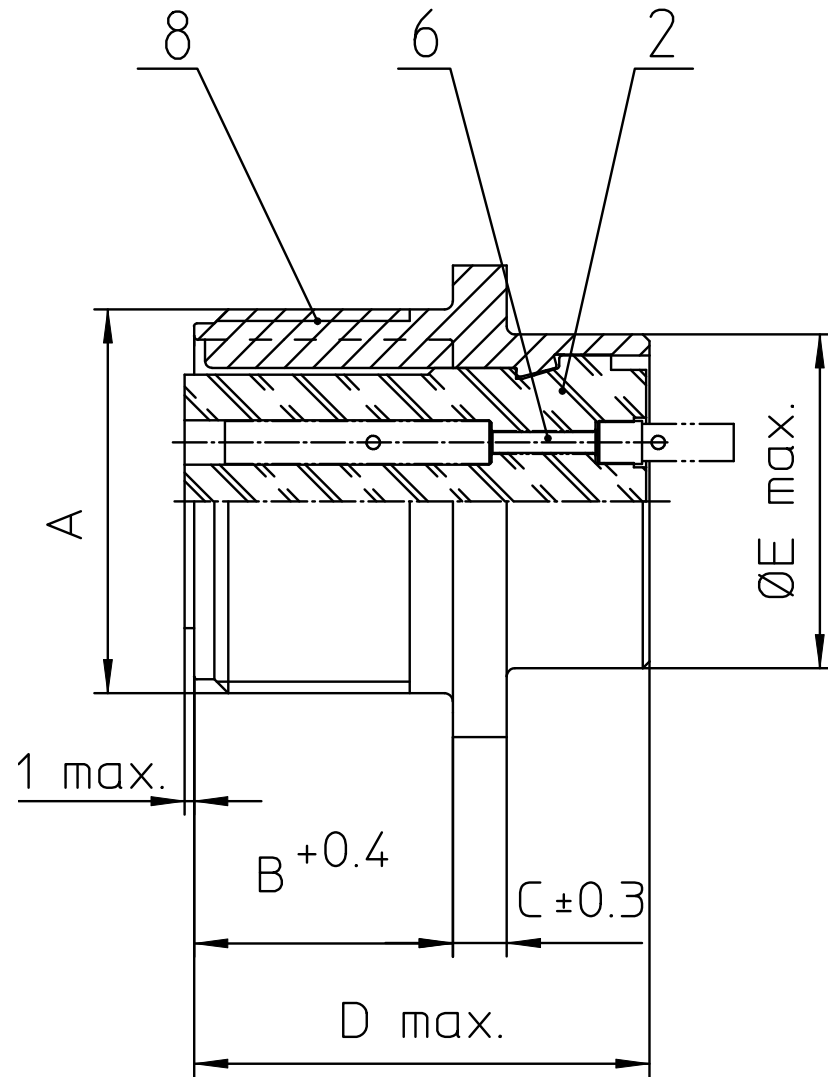
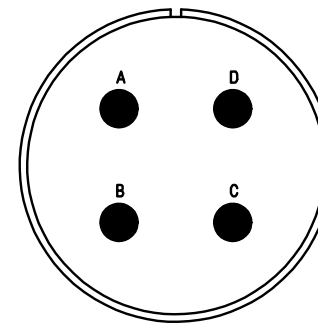

Note: Due to an automatic nomenclature system, numbers generated may not be sequential.
 Specification and Dimensions subject to change
 Drawings illustrate normal insulator positioning

Material Specification:
Shell Material: Aluminium alloy
Shell Plating: Olive drab chromate coating over cadmium plating
Insulator Material: Neoprene
Contact Material: Copper alloy
Contact Plating: Hard silver

all dimensions are in mm
 Dimensions without tolerance indications are general tolerances in acc. with DIN7168m

drawing for
 CUSTOMER



description CA3102E24-22S
 Box mounting receptacle

Solder Cup / Socket / Layout: 24-22

© All rights reserved. Reproduction or issue to third in any form
 whatever is only permitted with written authorization of ITT Cannon



page 1/1

revision 769 16. Jul 18