

REACT TO THE TEMPERATURE WITH THIS

HEAT ACTIVATED SWITCH KIT

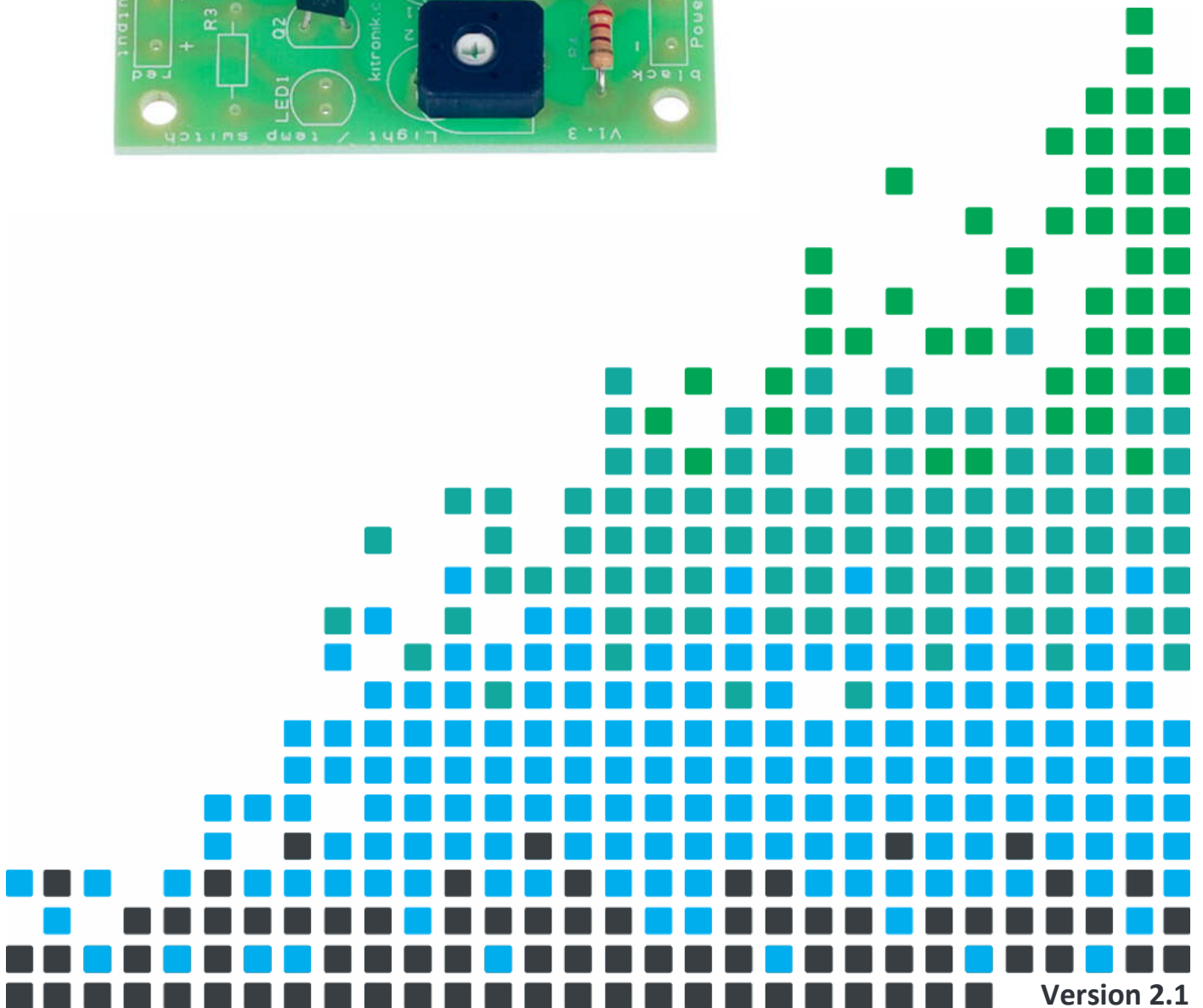
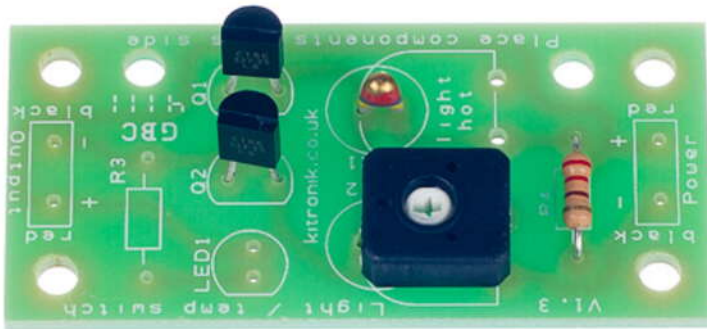

Index of Sheets

TEACHING RESOURCES

- Index of Sheets
- Introduction
- Technical specification
- Soldering in Ten Steps
- Resistor Values
- Thermistor
- Using a Transistor as a Switch
- Darlington Pair

ESSENTIAL INFORMATION

- Build Instructions – Cold activated
- Build Instructions – Heat activated
- Checking Your Heat Activated Switch Board
- Testing the PCB
- How the heat activated switch works – Cold activated
- How the heat activated switch works – Heat activated
- Applications
- Online Information



Introduction

About the project kit

Both the project kit and the supporting material have been carefully designed for use in KS3 Design and Technology lessons. The project kit has been designed so that even teachers with a limited knowledge of electronics should have no trouble using it as a basis from which they can form a scheme of work.

Using the booklet

This booklet is intended as an aid for teachers when planning and implementing their scheme of work.

Please feel free to print any pages of this booklet to use as student handouts in conjunction with Kitronik project kits.

Support and resources

You can also find additional resources at www.kitronik.co.uk. There are component fact sheets, information on calculating resistor and capacitor values, puzzles and much more.

Kitronik provide a next day response technical assistance service via e-mail. If you have any questions regarding this kit or even suggestions for improvements, please e-mail us at:

support@kitronik.co.uk

Alternatively, phone us on 0845 8380781.

Technical specification

Supply Voltage

Minimum = 3V

Maximum = 12V

A supply voltage of 3V to 5V allows for better adjustment

Output voltage

Vout = Supply voltage less 0.9V

Output current

Maximum = 0.5A

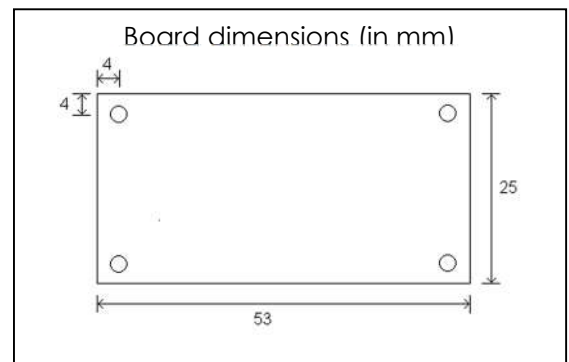

Guidance note

You should ensure that you have a stable power source when using the output to switch on high output loads. This is because if the power source is unable to provide enough power this may result in a supply voltage dip and cause output to switch off. At this point the voltage is likely to recover and turns the output on again. The output would then be in state where it is rapidly switching on and off.



Soldering in Ten Steps

1. Start with the smallest components working up to the taller components, soldering any interconnecting wires last.
2. Place the component into the board, making sure that it goes in the right way around and the part sits flush against the board.
3. Bend the leads slightly to secure the part.
4. Make sure that the soldering iron has warmed up and if necessary, use the damp sponge to clean the tip.
5. Place the soldering iron on the pad.
6. Using your free hand, feed the end of the solder onto the pad (top picture).
7. Remove the solder, then the soldering iron.
8. Leave the joint to cool for a few seconds.
9. Using a pair of cutters, trim the excess component lead (middle picture).
10. If you make a mistake heat up the joint with the soldering iron, whilst the solder is molten, place the tip of your solder extractor by the solder and push the button (bottom picture).

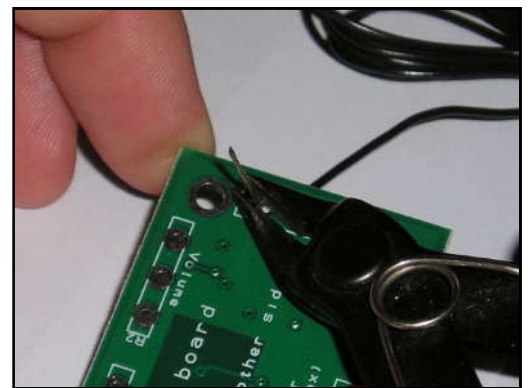
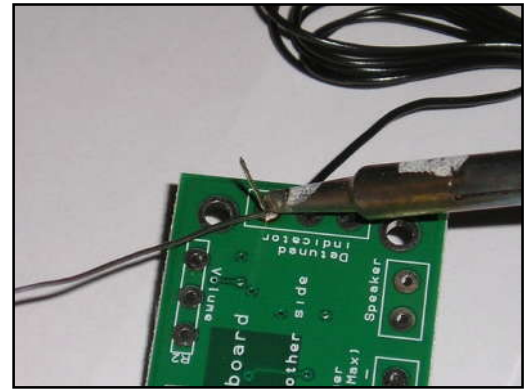

Solder joints

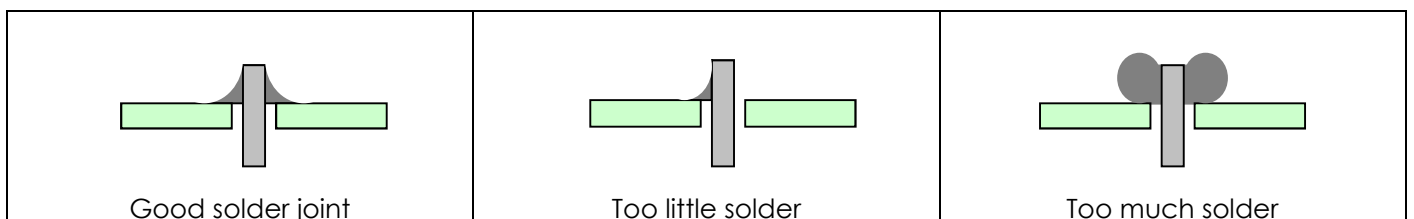

Resistor Values

A resistor is a device that opposes the flow of electrical current. The bigger the value of a resistor, the more it opposes the current flow. The value of a resistor is given in Ω (ohms) and is often referred to as its 'resistance'.

Identifying resistor values

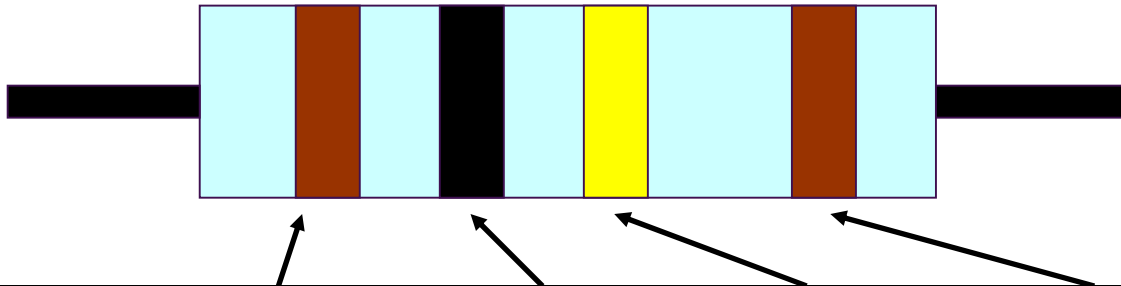

Band Colour	1st Band	2nd Band	Multiplier x	Tolerance
Silver			$\div 100$	10%
Gold			$\div 10$	5%
Black	0	0	1	
Brown	1	1	10	1%
Red	2	2	100	2%
Orange	3	3	1000	
Yellow	4	4	10,000	
Green	5	5	100,000	
Blue	6	6	1,000,000	
Violet	7	7		
Grey	8	8		
White	9	9		

Example: Band 1 = Red, Band 2 = Violet, Band 3 = Orange, Band 4 = Gold

The value of this resistor would be:

$$\begin{aligned}
 & 2 \text{ (Red)} \ 7 \text{ (Violet)} \times 1,000 \text{ (Orange)} & = 27 \times 1,000 \\
 & & = 27,000 \text{ with a 5% tolerance (gold)} \\
 & & = 27K\Omega
 \end{aligned}$$

Too many zeros?

Kilo ohms and mega ohms can be used:

$$1,000\Omega = 1K$$

$$1,000K = 1M$$

Resistor identification task

Calculate the resistor values given by the bands shown below. The tolerance band has been ignored.

1st Band	2nd Band	Multiplier x	Value
Brown	Black	Yellow	
Green	Blue	Brown	
Brown	Grey	Yellow	
Orange	White	Black	



Calculating resistor markings

Calculate what the colour bands would be for the following resistor values.

Value	1st Band	2nd Band	Multiplier x
180 Ω			
3,900 Ω			
47,000 (47K) Ω			
1,000,000 (1M) Ω			

What does tolerance mean?

Resistors always have a tolerance but what does this mean? It refers to the accuracy to which it has been manufactured. For example if you were to measure the resistance of a gold tolerance resistor you can guarantee that the value measured will be within 5% of its stated value. Tolerances are important if the accuracy of a resistors value is critical to a design's performance.

Preferred values

There are a number of different ranges of values for resistors. Two of the most popular are the E12 and E24. They take into account the manufacturing tolerance and are chosen such that there is a minimum overlap between the upper possible value of the first value in the series and the lowest possible value of the next. Hence there are fewer values in the 10% tolerance range.

E-12 resistance tolerance ($\pm 10\%$)											
10	12	15	18	22	27	33	39	47	56	68	82

E-24 resistance tolerance ($\pm 5\%$)											
10	11	12	13	15	16	18	20	22	24	27	30
33	36	39	43	47	51	56	62	68	75	82	91



Thermistor

A thermistor is a component that has a resistance that changes with temperature. There are two types of thermistor. Those with a resistance that increase with temperature (Positive Temperature Coefficient – PTC) and those with a resistance that falls with temperature (Negative Temperature Coefficient – NTC).

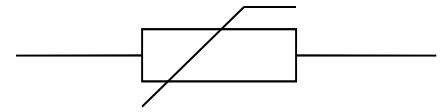

Temperature coefficient

Most have a resistance that falls as the temperatures increases (NTC).

The amount by which the resistance decrease as the temperature decreases is not constant. It varies with temperature. A formula can be used to calculate the resistance of the thermistor at any given temperature. Normally these are calculated for you and the information can be found in the devices datasheet.

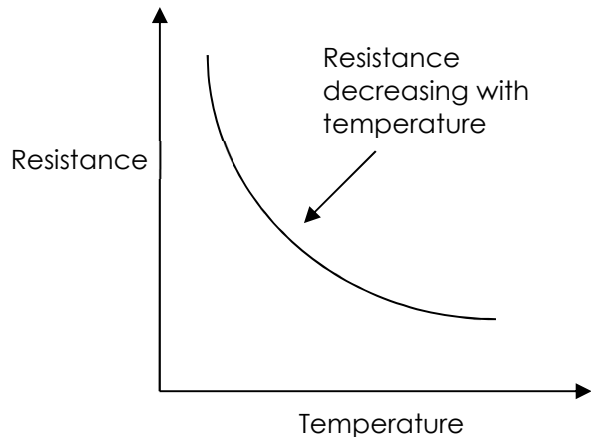

Applications

There are many applications for a thermistor. Three of the most popular are listed below.

Temperature sensing

The most obvious application for a thermistor is to measure temperature. They are used to do this in a wide range of products such as thermostats.

In rush current limiting

In this application the thermistor is used to initially oppose the flow of current (by having a high resistance) into a circuit. Then as the thermistor warms up (due to the flow of electricity through the device) its resistance drops letting current flow more easily.

Circuit protection

In this application the thermistor is used to protect a circuit by limiting the amount of current that can flow into it. If too much current starts to flow into a circuit through the thermistor this causes the thermistor to warm up. This in turn increases the resistance of the thermistor reducing the current that can flow into the circuit.

Example

The circuit shown right shows a simple way of constructing a circuit that turns on when it goes hot. The decrease in resistance of the thermistor in relation to the other resistor which is fixed as the temperature rises will cause the transistor to turn on. The value of the fixed resistor will depend on the thermistor used, the transistor used and the supply voltage.

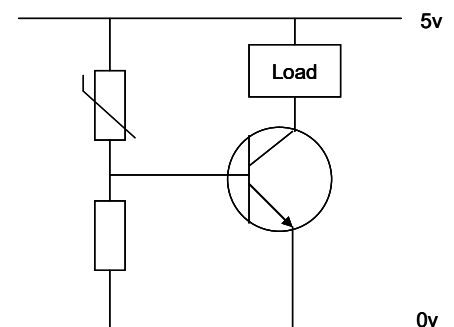

Using a Transistor as a Switch

Overview

A transistor in its simplest form is an electronic switch. It allows a small amount of current to switch a much larger amount of current either on or off. There are two types of transistors: NPN and PNP. The different order of the letters relate to the order of the N and P type material used to make the transistor. Both types are available in different power ratings, from signal transistors through to power transistors. The NPN transistor is the more common of the two and the one examined in this sheet.

Schematic symbol

The symbol for an NPN type transistor is shown to the right along with the labelled pins.

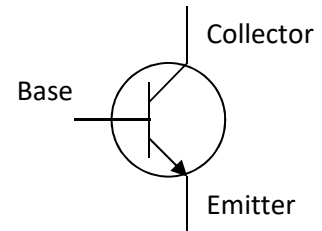

Operation

The transistor has three legs: the base, collector and the emitter. The emitter is usually connected to 0V and the electronics that is to be switched on is connected between the collector and the positive power supply (Fig A). A resistor is normally placed between the output of the Integrated Circuit (IC) and the base of the transistor to limit the current drawn through the IC output pin.

The base of the transistor is used to switch the transistor on and off. When the voltage on the base is less than 0.7V, it is switched off. If you imagine the transistor as a push to make switch, when the voltage on the base is less than 0.7V there is not enough force to close the switch and therefore no electricity can flow through it and the load (Fig B). When the voltage on the base is greater than 0.7V, this generates enough force to close the switch and turn it on. Electricity can now flow through it and the load (Fig C).

Fig A – Basic transistor circuit

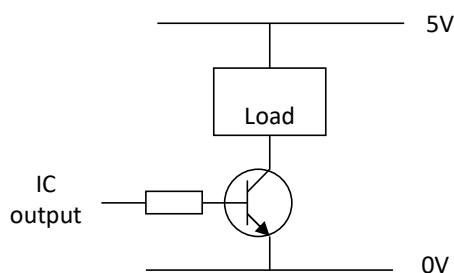

Fig B – Transistor turned off

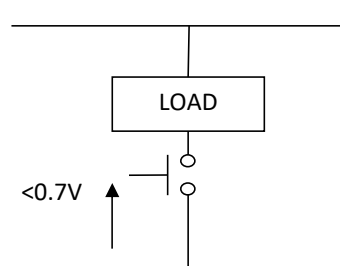
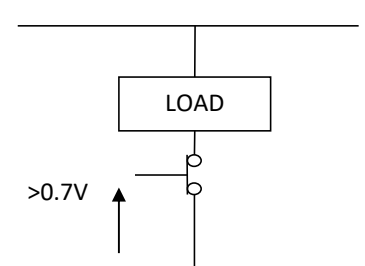
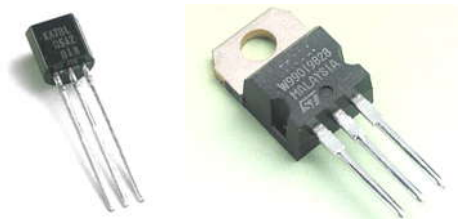

Fig C – Transistor turned on



Current rating

Different transistors have different current ratings. The style of the package also changes as the current rating goes up. Low current transistors come in a 'D' shaped plastic package, whilst the higher current transistors are produced in metal cans that can be bolted onto heat sinks so that they don't over heat. The 'D' shape or a tag on the metal can is used to work out which pin does what. All transistors are wired differently so they have to be looked up in a datasheet to find out which pin connects where.



Darlington Pair

What is a Darlington Pair?

A Darlington Pair is two transistors that act as a single transistor but with a much higher current gain.

What is current gain?

Transistors have a characteristic called 'current gain'. This is referred to as its h_{FE} .

The amount of current that can pass through the load when connected to a transistor that is turned on equals the **input current x the gain of the transistor (h_{FE})**.

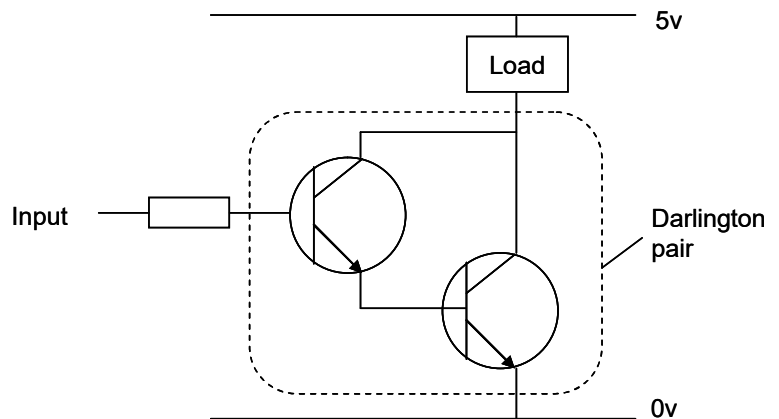

The current gain varies for different transistor and can be looked up in the datasheet for the device. Typically, it may be 100. This would mean that the current available to drive the load would be 100 times larger than the input to the transistor.

Why use a Darlington Pair?

In some applications, the amount of input current available to switch on a transistor is very low. This may mean that a single transistor may not be able to pass sufficient current required by the load.

As stated earlier, this equals the **input current x the gain of the transistor (h_{FE})**. If it is not possible to increase the input current, then we need to increase the gain of the transistor. This can be achieved by using a Darlington Pair.

A Darlington Pair acts as one transistor but with a current gain that equals:

Total current gain ($h_{FE \text{ total}}$) = current gain of transistor 1 ($h_{FE t1}$) x current gain of transistor 2 ($h_{FE t2}$)

So, for example, if you had two transistors with a current gain (h_{FE}) = 100:

$$(h_{FE \text{ total}}) = 100 \times 100$$

$$(h_{FE \text{ total}}) = 10,000$$

You can see that this gives a vastly increased current gain when compared to a single transistor. Therefore, this will allow a very low input current to switch a much larger load current.

Base activation voltage

In order to turn on a transistor, the base input voltage of the transistor will (normally) need to be greater than 0.7V. As two transistors are used in a Darlington Pair, this value is doubled. Therefore, the base voltage will need to be greater than $0.7V \times 2 = 1.4V$.

It is also worth noting that the voltage drop across the collector and emitter pins of the Darlington Pair when they turn on will be around 0.9V. Therefore if the supply voltage is 5V (as above) the voltage across the load will be will be around 4.1V ($5V - 0.9V$).



REACT TO THE TEMPERATURE WITH THIS

HEAT ACTIVATED SWITCH KIT

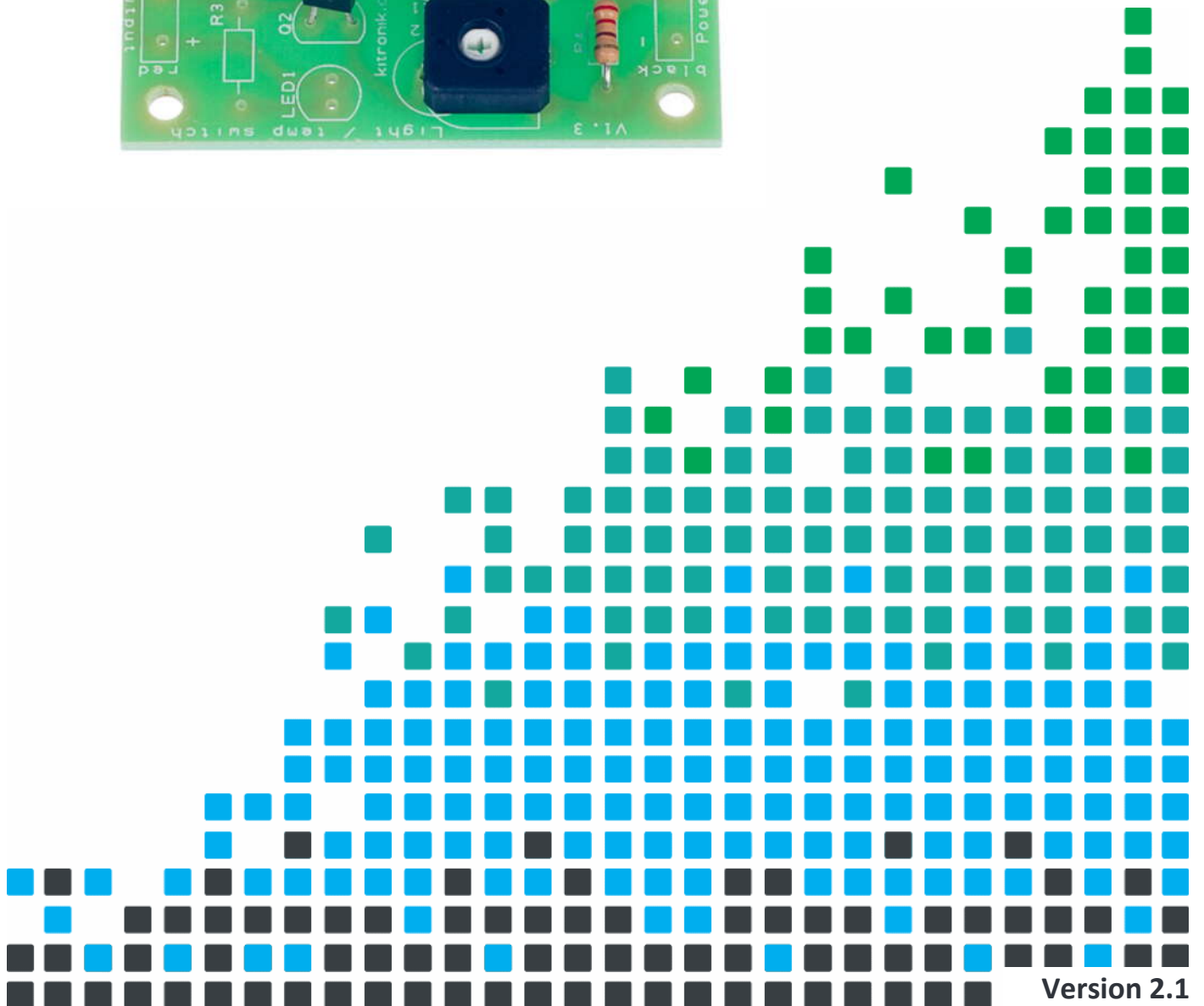
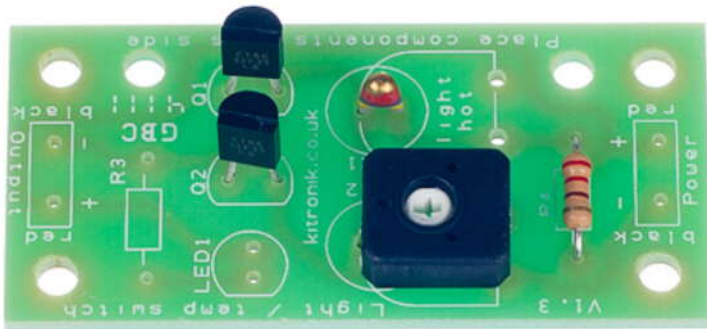

Build Instructions – Cold activated

Before you start, take a look at the Printed Circuit Board (PCB). The components go in the side with the writing on and the solder goes on the side with the tracks and silver pads.

1

PLACE THE RESISTORS

Start with the resistor:

The text on the PCB shows where R1, go.

Ensure that you put the resistors in the right place.

PCB Ref	Value	Colour Bands
R4	220 Ω	Red, red, brown



2

Place the Transistors

Now place the two transistors. They should be placed into Q1 and Q2. It is important that they are inserted in the correct orientation. Ensure the shape of the device matches the outline printed on the PCB. Once you are happy solder the devices into place.



3

Place the variable resistor

Place the variable resistor into R1. It will only fit in the holes in the board when it is the correct way around.



4

Place the thermistor

Solder the thermistor in to the circle indicated by the text R2. This is next to the 'cold' text. It does not matter which way around it is inserted.



Connecting power

There are two power terminals on the PCB to allow power to be connected. These are identified by the text 'power' on the PCB.

- The positive power connection should be connected to the terminal indicated by the text '+' and 'red'
- The negative power connection should be connected to the terminal indicated by the text '-' and 'black'

Connecting an LED

The circuit can be used to turn on a LED. The LED should be soldered into the LED1 on the PCB. A current limit resistor must also be placed in the R3 on the PCB. The value of R3 will depend on the LED used and the supply voltage. For a standard LED and a 5V supply voltage a 220 Ω would be suitable. Connecting an external circuit to the boards output

The circuit can be used to control another device. To do this the device that is to be controlled should be connected to the terminals labelled output. When the circuit is activated the output turns on and can be used to turn on the device to which it is connected.

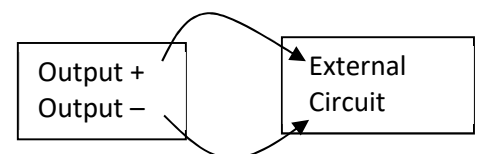

Note: This output will be around 0.9V lower than that connected to the PCB.



Build Instructions – Heat activated

Before you start, take a look at the Printed Circuit Board (PCB). The components go in the side with the writing on and the solder goes on the side with the tracks and silver pads.

1 PLACE THE RESISTORS

Start with the resistor:

The text on the PCB shows where R1, go.

Ensure that you put the resistors in the right place.

PCB Ref	Value	Colour Bands
R4	220 Ω	Red, red, brown



2 Place the Transistors

Now place the two transistors. They should be placed into Q1 and Q2. It is important that they are inserted in the correct orientation. Ensure the shape of the device matches the outline printed on the PCB. Once you are happy solder the devices into place.



3 Place the thermistor

Solder the thermistor in to the circle indicated by the text R1. This is next to the 'hot' text. It does not matter which way around it is inserted.



4 Place the variable resistor

Place the variable resistor into R2. It will only fit in the holes in the board when it is the correct way around.



Connecting power

There are two power terminals on the PCB to allow power to be connected. These are identified by the text 'power' on the PCB.

- The positive power connection should be connected to the terminal indicated by the text '+' and 'red'
- The negative power connection should be connected to the terminal indicated by the text '-' and 'black'

Connecting an LED

The circuit can be used to turn on a LED. The LED should be soldered into the LED1 on the PCB. A current limit resistor must also be placed in the R3 on the PCB. The value of R3 will depend on the LED used and the supply voltage. For a standard LED and a 5V supply voltage a 220 Ω would be suitable. Connecting an external circuit to the boards output

The circuit can be used to control another device. To do this the device that is to be controlled should be connected to the terminals labelled output. When the circuit is activated the output turns on and can be used to turn on the device to which it is connected.

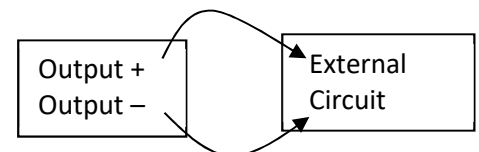

Note: This output will be around 0.9V lower than that connected to the PCB.



Checking Your Heat Activated Switch Board

Check the following before you connect power to the board:

Check the bottom of the board to ensure that:

- All these leads are soldered
- Pins next to each other are not soldered together

Check the top of the board to ensure that:

- The body of the two transistors match the outline on the PCB

Testing the PCB

Cold activated circuit

- Turn the variable resistor R1 fully clockwise (high resistance = $47K\Omega$). At this point the output should be off (and the LED if fitted).
- Now turn the variable resistor R1 anti-clockwise until the output turns on (and the LED if fitted).
- Turn the variable resistor R1 back clockwise. Note the point at which the output (and the LED if fitted) turns back off. This is the trip point for the current temperature.
- If you want the circuit to trip at a lower temperature then adjust R1 forward in the clockwise direction.
- If you want the circuit to trip at a higher temperature then adjust R1 back in the anti-clockwise direction.
- Some experimentation maybe required to set the correct trip point.

Heat activated circuit

- Turn the variable resistor R2 fully clockwise (high resistance = $47K\Omega$). At this point the output should be on (and the LED if fitted).
- Now turn the variable resistor R2 anti-clockwise until the output turns off (and the LED if fitted).
- Turn the variable resistor R2 back clockwise. Note the point at which the output (and the LED if fitted) turns back on. This is the trip point for the current temperature.
- If you want the circuit to trip at a lower temperature then adjust R2 forward in the clockwise direction.
- If you want the circuit to trip at a higher temperature then adjust R2 back in the anti-clockwise direction.
- Some experimentation maybe required to set the correct trip point.



How the heat activated switch works – Cold activated

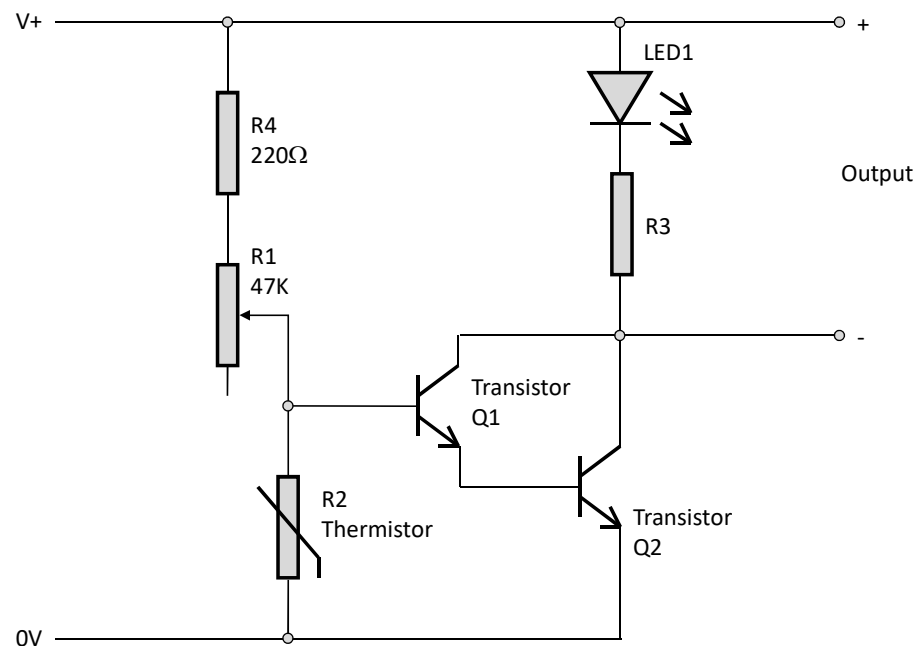

The circuit operation is very simple. When the input to the transistor Q1, which is fed from the connecting point of R1 and R2, is greater than 1.4V the output is turned on. The voltage at the join of R1 and R2 is determined by the ratio of the two resistors. This is known as potential divider.

Voltage at the join of R1 and R2 = The supply Voltage x $(R1/(R1+R2))$

Normally it requires 0.7V to turn on a transistor but this circuit uses two transistors in a Darlington Pair meaning it requires $2 \times 0.7V = 1.4V$ to turn on both transistors.

It is also worth noting that the output, when turned on, will be around 0.9V lower than the supply voltage V+. This is because of the voltage drop across the collector and emitter pins of the Darlington Pair of transistors. Therefore if the supply voltage is 5V then the output voltage will be around 4.1V.

R4 is present to protect the transistor should the variable resistor be set to zero.

Adjusting the trigger level

The point at which the circuit is triggered is set by the 47KΩ variable resistor. By varying the value of this resistor the ratio of the resistance of R1 and R2 can be varied to a point where a centre voltage (trip point) of 1.4V is achieved at the desired light level.

LED (if fitted)

If LED1 and R3 are fitted the LED will light at this point. The value of R3 should be selected for the relevant supply voltage on LED used. A standard LED would require around 10mA (0.01A) producing a normal brightness. As stated a 5V supply would give 4.1V across LED1 and R3. The LED1 would use 1.9V leaving around 2.2V (4.1V-1.9V) across R3.

Using $R = V/I$ $R3 = 2.2 / 0.01$ $R3 = 220\Omega$



How the heat activated switch works – Heat activated

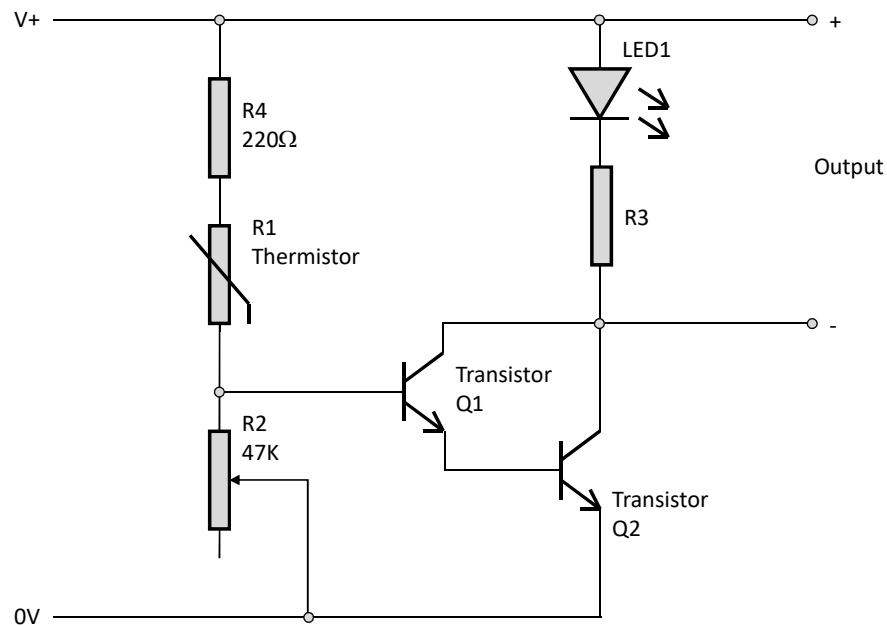

The circuit operation is very simple. When the input to the transistor Q1, which is fed from the connecting point of R1 and R2, is greater than 1.4V the output is turned on. The voltage at the join of R1 and R2 is determined by the ratio of the two resistors. This is known as potential divider.

Voltage at the join of R1 and R2 = The supply Voltage x (R1/(R1+R2))

Normally it requires 0.7V to turn on a transistor but this circuit uses two transistors in a Darlington Pair meaning it requires $2 \times 0.7V = 1.4V$ to turn on both transistors.

It is also worth noting that the output, when turned on, will be around 0.9V lower than the supply voltage V+. This is because of the voltage drop across the collector and emitter pins of the Darlington Pair of transistors. Therefore if the supply voltage is 5V then the output voltage will be around 4.1V.

Note: R4 is only present to protect the transistor in the cold activated version (when the variable resistor is set to zero).

Adjusting the trigger level

The point at which the circuit is triggered is set by the 47KΩ variable resistor. By varying the value of this resistor the ratio of the resistance of R1 and R2 can be varied to a point where a centre voltage (trip point) of 1.4V is achieved at the desired light level.

LED (if fitted)

If LED1 and R3 are fitted the LED will light at this point. The value of R3 should be selected for the relevant supply voltage on LED used. A standard LED would require around 10mA (0.01A) producing a normal brightness. As stated a 5V supply would give 4.1V across LED1 and R3. The LED1 would use 1.9V leaving around 2.2V (4.1V-1.9V) across R3.

Using $R = V/I$ $R3 = 2.2 / 0.01$ $R3 = 220\Omega$



Applications

Heat activated fan/cooler

By using a temperature activated board built in the heat activated option and the addition of motor it is possible to make a heat activated fan (shown right). The fan can be set up to come on at a desired temperature by adjusting the variable resistor.

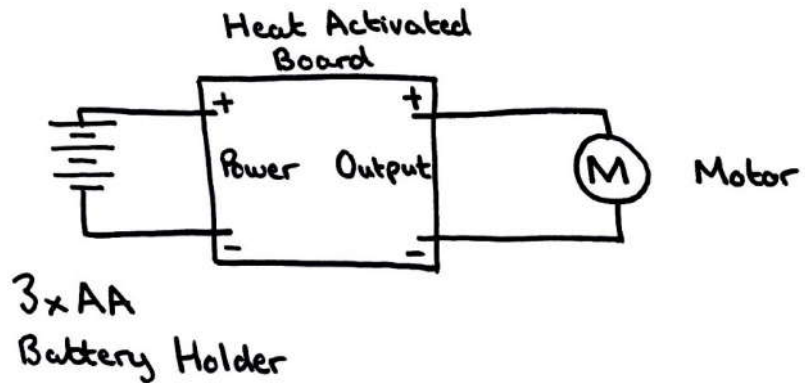

Parts list to build 100 heat activated fans:

Part no.	Description	Qty
2113	Temperature activated switch	100
2234-25	3 x AA battery cage with clip, pack of 25	4
2238-25	PP3 Battery clip lead, pack of 25	4
2501	Pack of 10 motors	10
2503	Pack of 10 motor clips	10
2201-40	Zinc Chloride AA batteries, box of 40	8

Babies bath over temperature indicator

By using a temperature activated board built in the heat activated option it is possible to make a simple babies bath too hot indicator. The 'too hot' state can be indicated by an LED that light by the addition of the 150Ω resistor (in R3) and red LED (in LED1).

The thermistor should be mounted on separate flying leads as the PCB should not be immersed in water.

Parts list to build 100 babies bath over temperature indicators:

Part no.	Description	Qty
2113	Temperature activated switch	10
2234-25	3 x AA battery cage with clip, pack of 25	4
2238-25	PP3 Battery clip lead, pack of 25	4
3003-150R	150ohm resistor, pack of 100	1
3504	Red 5mm LED, pack of 50	2
2201-40	Zinc Chloride AA batteries, box of 40	8



Online Information

Two sets of information can be downloaded from the product page where the kit can also be reordered from. The 'Essential Information' contains all of the information that you need to get started with the kit and the 'Teaching Resources' contains more information on soldering, components used in the kit, educational schemes of work and so on and also includes the essentials. Download from:

www.kitronik.co.uk/2113



This kit is designed and manufactured in the UK by Kitronik

Telephone: +44 (0) 845 8380781

Sales email: sales@kitronik.co.uk

Tech support email: support@kitronik.co.uk

Web: www.kitronik.co.uk



www.kitronik.co.uk/twitter



www.kitronik.co.uk/facebook



www.kitronik.co.uk/youtube



www.kitronik.co.uk/google

Every effort has been made to ensure that these notes are correct, however Kitronik accept no responsibility for issues arising from errors / omissions in the notes.

© Kitronik Ltd - Any unauthorised copying / duplication of this booklet or part thereof for purposes except for use with Kitronik project kits is not allowed without Kitronik's prior consent.

