

10 9 8 7 6 5 4 3 2 1

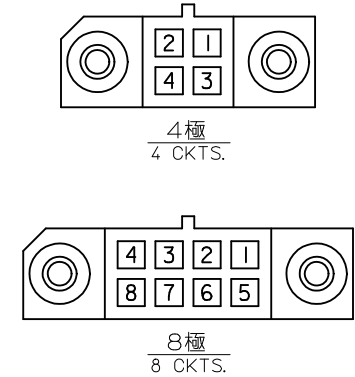
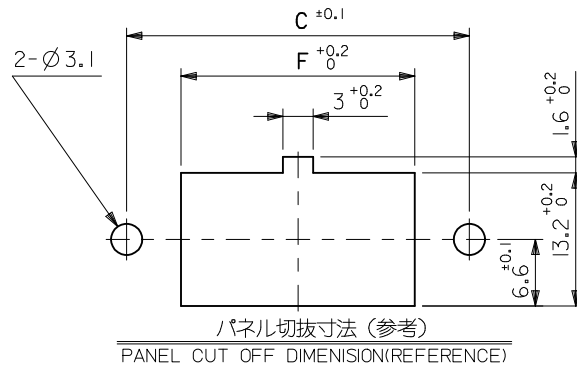
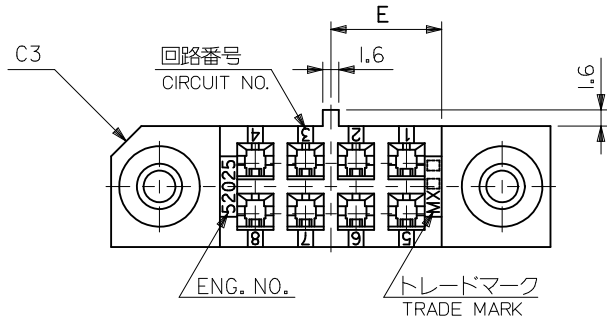

回路レイアウト図

注記 NOTES

- 適用ターミナル : 5558 シリーズ  
APPLICABLE TERMINAL : 5558 SERIES
- 嵌合相手 : 51010-\*\*\*  
MATES WITH : 51010-\*\*\*
- パネル外一外寸法 : 18.6 (下図参照)  
BETWEEN PANEL-PANEL DIMENSION : 18.6 (SEE BELOW FIGURE)

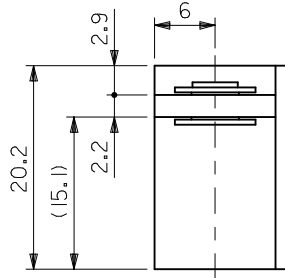
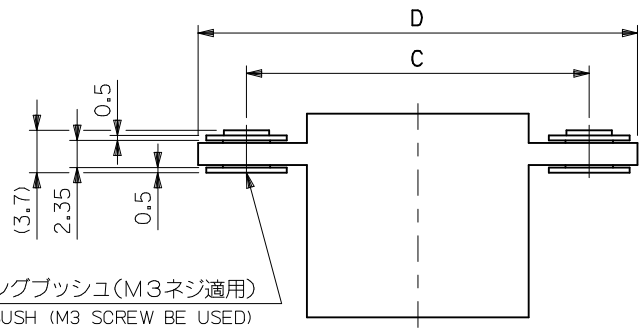

フローティングブッシュ(M3ネジ適用)  
FLOATING BUSH (M3 SCREW BE USED)

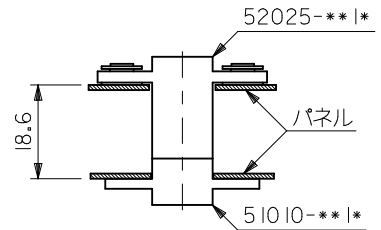
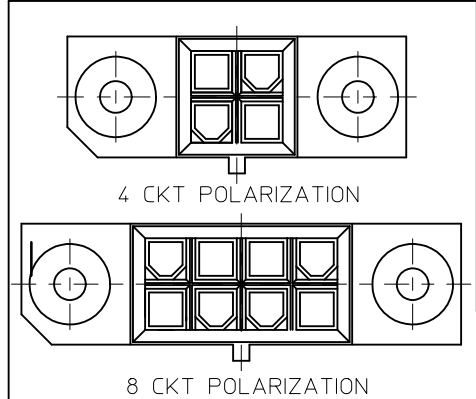
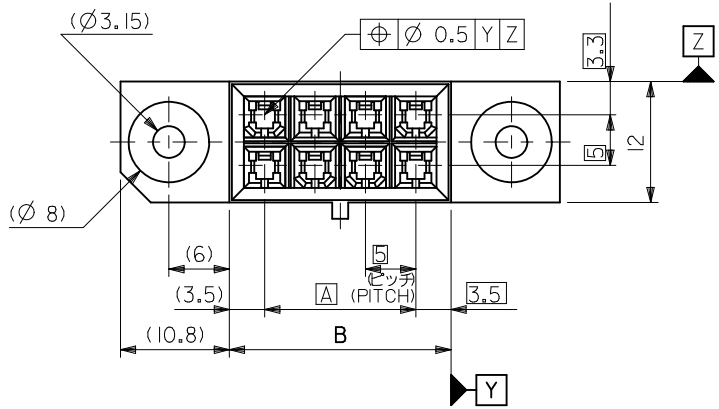

23.2	11	43.6	34	22	15	52025-0811	BLACK	8
13.2	6	33.6	24	12	5	52025-0411	BLACK	4
F	E	D	C	B	A	MATERIAL NO.	COLOR	極数 CKTS.

材料 MATERIAL  
本体 : G.F.15% PBTP, UL94V-0  
HOUSING : G.F.15% PBTP, UL94V-0  
ブッシュ : 黄銅, ニッケルメッキ  
BUSH : BRASS, NICKEL PLATING

ADD 4 & 8 CKT VIEW EC NO: UCP2012-1179 DRWN: NGUYEN CHKD: J.BELL APPR: FSM/TH	GENERAL TOLERANCES (UNLESS SPECIFIED)	DIMENSION STYLE MM ONLY	SCALE 2:1	DESIGN UNITS METRIC	THIRD ANGLE PROJECTION
	10 UNDER ±0.2	DRAWN BY T. HIRAMOTO	DATE '89/11/24	TITLE MINI. DRAWER CONN. CRIMP PIN HOUSING ASSY	
	10 OVER 30 UNDER ±0.25	CHECKED BY M. FUKUSHIMA	DATE '90/4/5	MOLEX INCORPORATED	
	30 OVER ±0.3	APPROVED BY M. ENOMOTO	DATE '90/4/5	DOCUMENT NO. SD-52025-001	SHEET NO. 1 OF 1
ANGULAR ±3 °	SEE TABLE				
DRAFT WHERE APPLICABLE MUST REMAIN WITHIN DIMENSIONS	THIS DRAWING CONTAINS INFORMATION THAT IS PROPRIETARY TO MOLEX INCORPORATED AND SHOULD NOT BE USED WITHOUT WRITTEN PERMISSION				