

# Assembly Instructions for - 37180

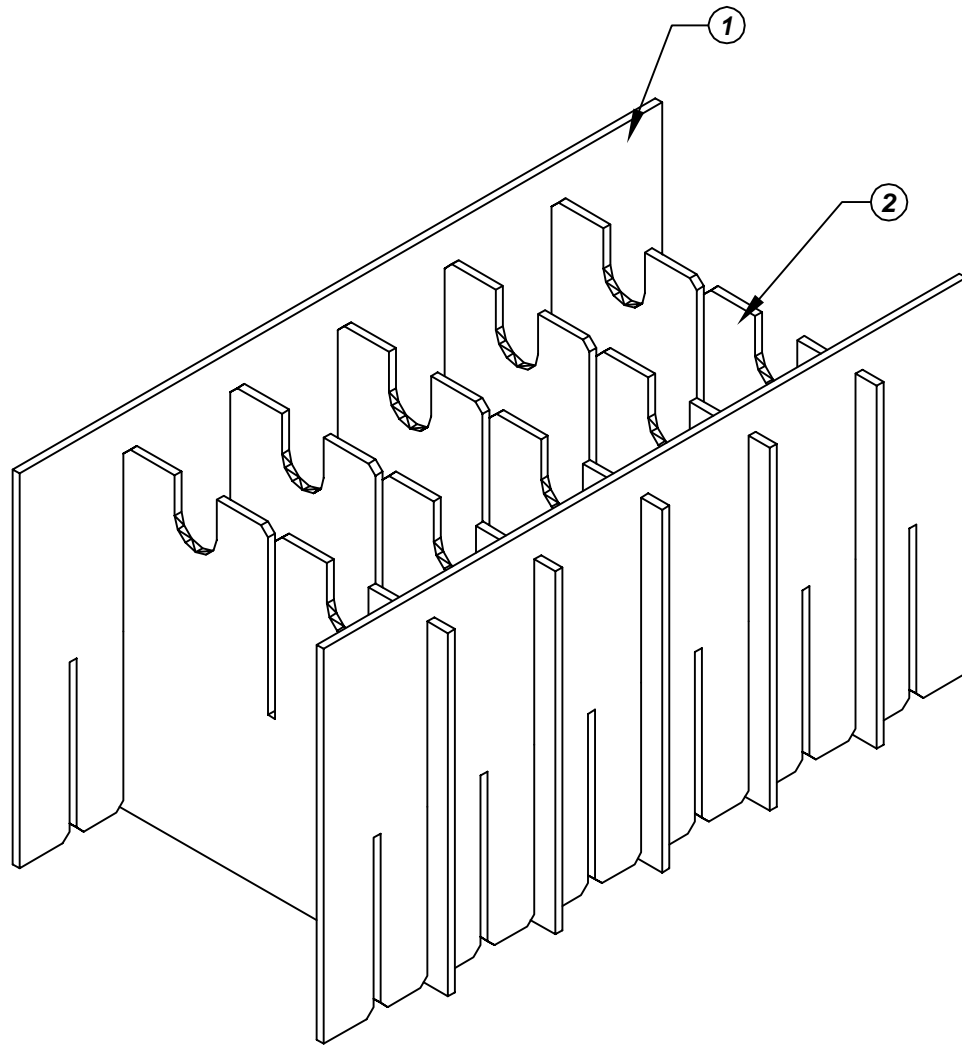

Folded Long Partition

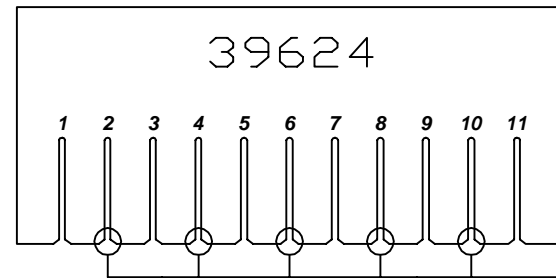

①

Use only the circled slots for partition assembly

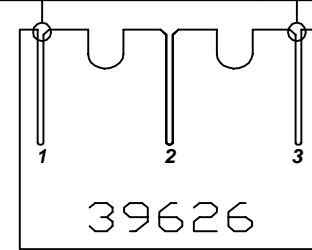

②

Folded Short Partition

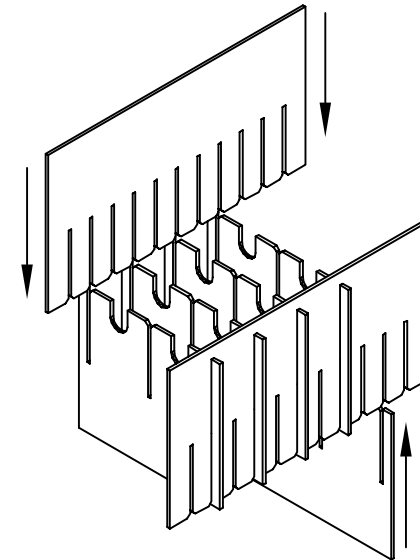

Made in America

F/N ①	Part # 39624	Dimensions: 24-3/4" x 23"	Description: 404-HLP Long Partition	Qty: 2
F/N ②	Part # 39626	Dimensions: 22-3/4" x 12-5/8"	Description: 404-HSP Short Partition	Qty: 5

**37180 - 6 Cell Inplant Handler**  
**Cell Size - 12-5/8" x 10-3/4" x 3-5/8"**

Notes:  
 For use with the following storage container & lid:  
 37504 - Storage Container  
 37552 - Lid

PROTEKTIVE PAK  
 13520 MONTE VISTA AVENUE, CHINO, CA 91710  
 PHONE (909) 627-2578, FAX (909) 363-7331  
 ProtoktivePak.com

**PROTEKTIVE PAK**  
 BURIED CONDUCTIVE LAYER

DRAWING NUMBER  
**IPH-37180**

DATE  
 Nov.  
 2007