

Preliminary Data Sheet

SPS30

Important Note:

- All specifications are preliminary and are subject to change without prior notice.
- Characterization and qualification of this product is ongoing.

This preliminary data sheet is confidential and must not be distributed to third parties without Sensirion's approval.

Preliminary Data Sheet SPS30

Particulate Matter Sensor for HVAC and Air Quality Applications

- Unique long-term stability
- Advanced particle size binning
- Superior accuracy in mass-concentration sensing
- Small, ultra-slim package
- Fully calibrated digital output



DISCLAIMER

ABSOLUTELY CONFIDENTIAL, SENSIRION PROPRIETARY INFORMATION. ALL DATA DECLARED HEREIN ARE INTENDED AS INDICATIVE ONLY. ONLY NON-GUARANTEED, TARGET SPECIFICATION ARE LISTED. SENSOR ITEM IS A NOT QUALIFIED ENGINEERING PART PROVIDED "AS IS." ANY EXPRESS OR IMPLIED WARRANTIES, INCLUDING, BUT NOT LIMITED TO, THE IMPLIED WARRANTIES OF MERCHANTABILITY AND FITNESS FOR A PARTICULAR PURPOSE ARE DISCLAIMED. IN NO EVENT SHALL SENSIRION BE LIABLE FOR ANY DIRECT, INDIRECT, INCIDENTAL, SPECIAL, EXEMPLARY, OR CONSEQUENTIAL DAMAGES OR INJURIES (INCLUDING, BUT NOT LIMITED TO, PROCUREMENT OF SUBSTITUTE GOODS OR SERVICES; LOSS OF USE, DATA, OR PROFITS; OR BUSINESS INTERRUPTION) HOWEVER CAUSED AND ON ANY THEORY OF LIABILITY, WHETHER IN CONTRACT, STRICT LIABILITY, OR TORT (INCLUDING NEGLIGENCE OR OTHERWISE) ARISING IN ANY WAY OUT OF THE USE OF THE SENSOR, EVEN IF ADVISED OF THE POSSIBILITY OF SUCH DAMAGE. USE UNDER OWN RESPONSIBILITY

Content

1 Particulate Matter Sensor Specifications	3
2 Electrical Specifications	5
3 Interface Specifications	6
4 Operation and Communication through the SHDLIC Protocol	6
5 Glossary	14
6 Technical Drawings	15
7 Important Notices	16
8 Headquarters and Subsidiaries	17

1 Particulate Matter Sensor Specifications

Default conditions of 25 °C and 5 V supply voltage apply to values in the table below, unless otherwise stated.

Parameter	Conditions	Value	Units
Mass concentration accuracy ¹	0 to 100 µg/m ³	±10	µg/m ³
	100 to 1'000 µg/m ³	±10	%
Mass concentration range	-	0 to 1'000	µg/m ³
Mass concentration resolution	-	1	µg/m ³
Mass concentration size range ²	PM1.0	0.3 to 1.0	µm
	PM2.5	0.3 to 2.5	µm
	PM4	0.3 to 4.0	µm
	PM10	0.3 to 10.0	µm
Number concentration size range ²	PM0.5	0.3 to 0.5	µm
	PM1.0	0.3 to 1.0	µm
	PM2.5	0.3 to 2.5	µm
	PM4	0.3 to 4.0	µm
	PM10	0.3 to 10.0	µm
Minimum sampling interval	-	1	s
Lifetime	24 h/day operation	> 8	years
Acoustic emission level	0.2 m	25	dB(A)
Weight	-	25	g

Table 1: Particulate Matter sensor specifications

¹ Accuracy is specified for PM2.5 using potassium chloride salt particles and the TSI DustTrak™ DRX Aerosol Monitor 8533 as a reference.

² PMx defines particles with a size smaller than "x" micrometers (e.g., PM2.5 = particles smaller than 2.5µm).

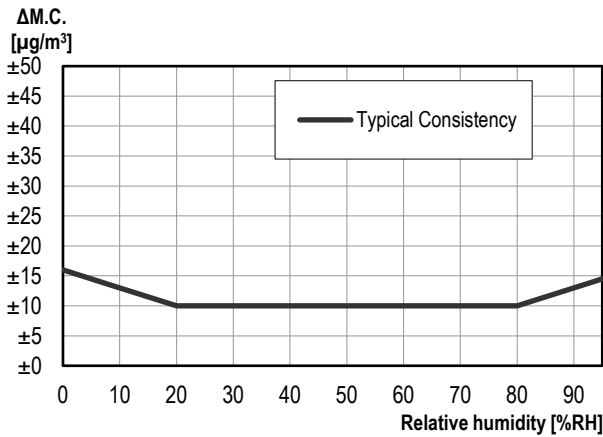

Figure 1: Typical consistency tolerance for PM2.5 in $\mu\text{g}/\text{m}^3$ at $25\text{ }^\circ\text{C}$ between $0\text{-}100\text{ }\mu\text{g}/\text{m}^3$.

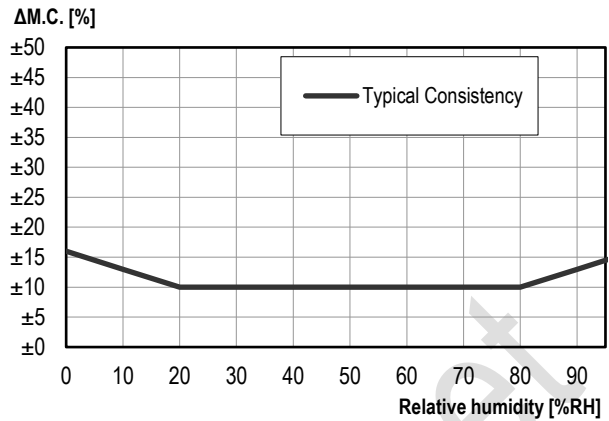

Figure 3: Typical consistency tolerance for PM2.5 in % of mass concentration at $25\text{ }^\circ\text{C}$ between $100\text{-}1000\text{ }\mu\text{g}/\text{m}^3$.

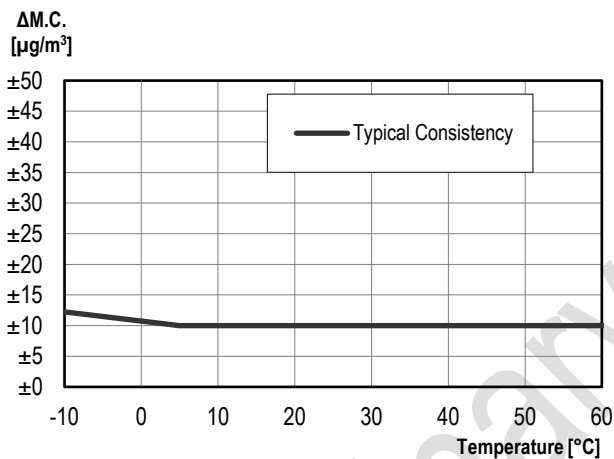

Figure 2: Typical consistency tolerance for PM2.5 in $\mu\text{g}/\text{m}^3$ between $0\text{-}100\text{ }\mu\text{g}/\text{m}^3$.

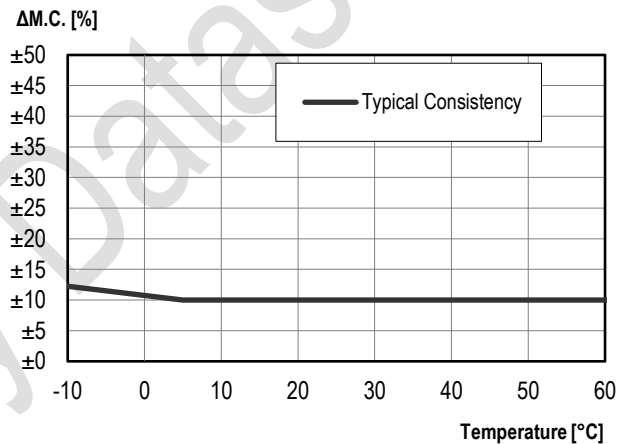

Figure 4: Typical consistency tolerance for PM2.5 in % between $100\text{-}1000\text{ }\mu\text{g}/\text{m}^3$.

1.1 Recommended Operating Conditions

The sensor shows best performance when operated within recommended normal temperature and humidity range of $10\text{ - }40\text{ }^\circ\text{C}$ and $20\text{ - }80\text{ \%RH}$, respectively.

2 Electrical Specifications

2.1 Electrical Characteristics

Default conditions of 25 °C and 5 V supply voltage apply to values in the table below, unless otherwise stated.

Parameter	Conditions	Value	Units
Supply voltage	-	4.5 to 5.5	V
Average supply current	Sampling interval 1 s	55	mA
Max supply current	Fan-cleaning mode	80	mA

Table 2: Electrical specifications

2.2 Absolute Maximum Ratings

Stress levels beyond those listed in Table 3 may cause permanent damage to the device. These are stress ratings only and functional operation of the device at these conditions cannot be guaranteed. Exposure to the absolute maximum rating conditions for extended periods may affect the reliability of the device.

Parameter	Rating
Operating temperature range	-10 to +60 °C
Storage temperature range	-40 to +70 °C
Operating humidity range	0 to 95 %RH (non-condensing)

Table 3: Absolute maximum ratings.

3 Interface Specifications

3.1 UART hardware interface

The sensor is equipped with a serial communication interface. The interface connector S5B-ZR-SM4A-TF(LF)(SN) is located at the side of the sensor opposite to the air inlet/outlet. Corresponding male plug is ZHR-5 from JST Sales America Inc. In Figure 3 a description of the pin layout is given.

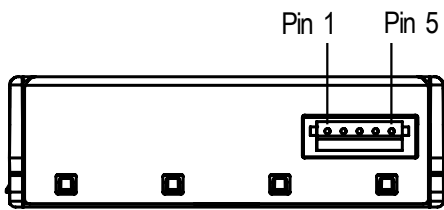

Figure 3 The communication interface connector (type: S5B-ZR-SM4A-TF(LF)(SN)) is located at the side of the sensor opposite to the air outlet.

Pin	Name	Comments
1	VDD	Supply voltage: 5V ± 10%
2	UART RX	Receiving pin for serial communication, TTL level = 3.3 V
3	UART TX	Transmitting pin for serial communication, TTL level = 3.3 V
4	NC	Do not connect
5	GND	Ground

Table 4 SPS30 pin assignment. Pin 4 is currently not used and should be left floating.

4 Operation and Communication through the SHDLIC Protocol

SHDLIC is serial communication protocol based on a master/slave architecture. On this sensor module, SHDLIC runs on top of UART.

4.1 Physical Layer

The SHDLIC protocol is a half-duplex protocol, which means it can operate on separated RX and TX lines or share the lines for RX and TX (for example RS-485 half duplex). For the SPS30 sensor we use separate RX and TX lines with unipolar logic levels. A transmitted byte looks as in Figure 4.

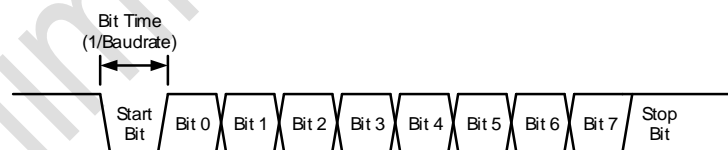

Figure 4 Transmitted byte.

The following UART settings are to be used:

- Baud Rate: 115'200 bit/s
- Data Bits: 8
- Parity: None
- Stop Bit: 1

4.2 SHDLC Frame Layer

Data is transferred in logical units called frames. Every transfer is initiated by the master sending a MOSI frame. The slave will respond to the MOSI frame with a slave response (or MISO frame). The two types of frames are shown in Figure 5.

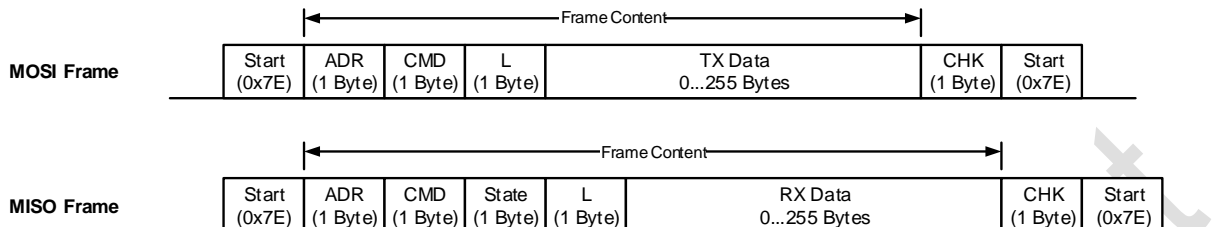

Figure 5 MOSI and MISO frames structure.

4.2.1 Start and Stop Byte (0x7E)

The 0x7E character is sent at begin and end of the frame to signalize frame start and stop. If this byte (0x7E) occurs anywhere else in the frame, it will be replaced by another two bytes (byte-stuffing). Use Table 5 for byte-stuffing.

Original data byte	Transferred data bytes
0x7E	0x7D, 0x5E
0x7D	0x7D, 0x5D
0x11	0x7D, 0x31
0x13	0x7D, 0x33

Table 5 Reference table for byte-stuffing.

Example: Data to send = [0x43, 0x11, 0x7F] → Data transmitted = [0x43, 0x7D, 0x31, 0x7F].

4.2.2 Address

The slave device address is always 0.

4.2.3 Command

In the MOSI frame the command tells the device what to do with the transmitted data. In the MISO frame, the slave just returns the received command.

4.2.4 Length

Length of the “TX Data” or “RX Data” field (before byte-stuffing).

4.2.5 State

The MISO frame contains a state byte, which allows the master to detect communication and execution errors. An additional error flag signalizes that the device is in an error state.

Figure 6 shows the composition of the Status byte.

b7	b6						b0
Device Error Flag	Execution error code						

Figure 6 Status byte structure.

The execution error code signalizes all errors which occur while processing the frame or executing the command.

4.2.6 Data

The data has a usable size of [0...255] bytes (original data, before byte-stuffing). The meaning of the data content depends on the command.

4.2.7 Checksum

The checksum is built before byte-stuffing and checked after removing stuffed bytes from the frame. The checksum is defined as follows:

1. Sum all bytes between start and stop (without start and stop bytes).
2. Take the LSB of the result and invert it. This will be the checksum.

For a MOSI frame use Address, Command, Length and Data to calculate the checksum.

For a MISO frame use Address, Command, State, Length and Data to calculate the checksum.

Example (MOSI frame without start/stop and without byte-stuffing):

Adr	CMD	L	Tx Data 4 Bytes	CHK
0x02	0x43	0x04	0x64, 0xA0, 0x22, 0xFC	0x94

The checksum is calculated as follows:

Adr	0x02
CMD	0x43
L	0x04
Data 0	0x64
Data 1	0xA0
Data 2	0x22
Data 3	0xFC
Sum	0x26B
LSB of Sum	0x6B
Inverted (=Checksum)	0x94

4.5 Commands

The following table shows an overview of the available commands.

CMD	Command	Read / Write / Execute
0x00	Start Measurement	Execute
0x01	Stop Measurement	Execute
0x03	Read Measured Value	Read
0x80	Get/Set Auto Cleaning Interval	Read / Write
0xD0	Device Information	Read
0xD3	Reset	Execute

4.5.1 Start Measurement³ (CMD: 0x00)

Starts the measurement. After power up, the module is in Idle-Mode. Before any measurement values can be read, the Measurement-Mode needs to be started using this command.

MOSI Data

Byte #	Datatype	Description
0	u8t	Sub-Command, this value must be set to 0x01
1	u8t	Measure-Mode, this value must be set to 0x03

MISO Data

No Data

Example Frames:

MOSI	0x7E 0x00 0x00 0x02 0x01 0x03 0xF9 0x7E
MISO	Empty response frame: 0x7E 0x00 0x00 0x00 0x00 0xFF 0x7E

4.5.2 Stop Measurement⁴ (CMD: 0x01)

Stops the measurement. Use this command to return to the initial state (Idle-Mode).

MOSI Data

No Data

MISO Data

No Data

Example Frames:

MOSI	0x7E 0x00 0x01 0x00 0xFE 0x7E
MISO	0x7E 0x00 0x01 0x00 0x00 0xFE 0x7E

³ This command can only be executed in Idle-Mode.

⁴ This command can only be executed in Measurement-Mode.

4.5.3 Read Measured Values (CMD: 0x03)

Reads the measured values from the module. This command can be used to poll for new measurement values. If no new measurements are available, the module returns an empty response frame. The default measurement interval is 1 second.

MOSI Data

No Data

MISO Data

If no new measurement values are available: No Data.

If new measurement values are available:

Byte #	Datatype	Description
0..3	float	Mass Concentration PM1.0 [$\mu\text{g}/\text{m}^3$]
4..7	float	Mass Concentration PM2.5 [$\mu\text{g}/\text{m}^3$]
8..11	float	Mass Concentration PM4.0 [$\mu\text{g}/\text{m}^3$]
12..15	float	Mass Concentration PM10 [$\mu\text{g}/\text{m}^3$]
16..19	float	Number Concentration PM0.5 [$\#/ \text{cm}^3$]
20..23	float	Number Concentration PM1.0 [$\#/ \text{cm}^3$]
24..27	float	Number Concentration PM2.5 [$\#/ \text{cm}^3$]
28..31	float	Number Concentration PM4.0 [$\#/ \text{cm}^3$]
32..35	float	Number Concentration PM10 [$\#/ \text{cm}^3$]
36..39	float	Typical Particle Size [μm]

Example Frames:

MOSI	0x7E 0x00 0x03 0x00 0xFC 0x7E
MISO	Empty response frame: 0x7E 0x00 0x03 0x00 0x00 0xFC 0x7E Or response frame with new measurement values: 0x7E 0x00 0x03 0x00 0x28 0x00 0xD4 0x7E

4.5.4 Get/Set Auto Cleaning Interval (CMD: 0x80)

Sets/gets the fan-cleaning interval [s]. When the module is in the Measurement-Mode an automatic fan-cleaning procedure will be triggered periodically following a defined cleaning interval. This will accelerate the fan to maximum speed for 10 seconds in order to blow out the dust accumulated inside the fan.

Important notes:

- Measurement values are not updated while fan-cleaning is running.
- Set the interval to 0 to disable the automatic cleaning.
- Once set, the interval is stored permanently in the non-volatile memory.
- The default cleaning interval is set to 168 hours.
- If the sensor is switched off, the time counter is reset to 0. Make sure to trigger a cleaning cycle at least every week, if the sensor is switched off and on periodically (e.g., once per day).

MOSI Data

Get Auto Cleaning Interval

Byte #	Datatype	Description
0	u8t	Sub-Command, this value must be set to 0x00

Set Auto Cleaning Interval

Byte #	Datatype	Description
0	u8t	Sub-Command, this value must be set to 0x00
1..4	u32t	Interval in seconds

MISO Data

Get Auto Cleaning Interval

Byte #	Datatype	Description
0..3	u8t	Interval in seconds

Set Auto Cleaning Interval

No Data

Example Frames:

MOSI	Get Auto Cleaning Interval: 0x7E 0x00 0x80 0x01 0x00 0x7D 0x5E 0x7E Set Auto Cleaning Interval to 0 (disable): 0x7E 0x00 0x80 0x05 0x00 0x00 0x00 0x00 0x7A 0x7E
MISO	Response frame for "Set Auto Cleaning Interval": 0x7E 0x00 0x80 0x00 0x04 0x00 0x00 0x00 0x7B 0x7E Response frame for "Set Auto Cleaning Interval": 0x7E 0x00 0x80 0x00 0x00 0x7F 0x7E

4.5.5 Device Information (CMD 0xD0)

This command returns the requested device information. It is defined as a string value with a maximum length of 32 ASCII characters (including terminating null character).

MOSI Data

Byte #	Datatype	Description
0	u8t	This parameter defines which information is requested: 0x01: Product Name 0x02: Article Code 0x03: Serial Number

MISO Data

Byte #	Datatype	Description
0...n	string	Requested Device Information as null-terminated ASCII string. The size of the string is limited to 32 ASCII characters (including null character).

Example Frames:

Product Name

MOSI	0x7E 0x00 0xD0 0x01 0x01 0x2D 0x7E
MISO	0x7E 0x00 0xD0 0x00 0x0D 0x48 0x65 0x6C 0x6C 0x6F 0x20 0x57 0x6F 0x72 0x6C 0x64 0x21 0x00 0xE5 0x7E

Article Code

MOSI	0x7E 0x00 0xD0 0x01 0x02 0x2C 0x7E
MISO	0x7E 0x00 0xD0 0x00 0x0C 0x78 0x2D 0x78 0x78 0x78 0x78 0x78 0x78 0x2D 0x78 0x78 0x00 0x91 0x7E

Serial Number

MOSI	0x7E 0x00 0xD0 0x01 0x03 0x2B 0x7E
MISO	0x7E 0x00 0xD0 0x00 0x15 0x30 0x00 0x5A 0x7E

4.5.6 Device Reset (CMD: 0xD3)

Soft reset command. After calling this command, the module is in the same state as after a Power-Reset. The reset is executed after sending the MISO response frame.

MOSI Data

No Data

MISO Data

No Data

Example Frames:

MOSI	0x7E 0x00 0xD3 0x00 0x2C 0x7E
MISO	0x7E 0x00 0xD3 0x00 0x00 0x2C 0x7E

4.6 Error Codes

The following table shows the error codes which can be reported from the device. Note that some of these errors are system internal errors which require additional knowledge to understand. In case of a problem, they will help Sensirion to localize and solve the issue.

Error Code		Meaning
dec	hex	
0	0x00	No Error
1	0x01	Wrong data length for this command (too much or little data)
2	0x02	Unknown command
3	0x03	No access right for command
4	0x04	Illegal command parameter or parameter out of allowed range
40	0x28	Internal function argument out of range
67	0x43	Command not allowed in current state

5 Glossary

SHDL	Sensirion High-Level Data Link Control
UART	Universal Asynchronous Receiver Transmitter
MOSI	Master Out Slave In. Frame direction from master to slave.
MISO	Master In Slave Out. Frame direction from slave to master.
MSB	Most Significant Byte
LSB	Least Significant Byte

6 Technical Drawings

6.1 Product outline drawings

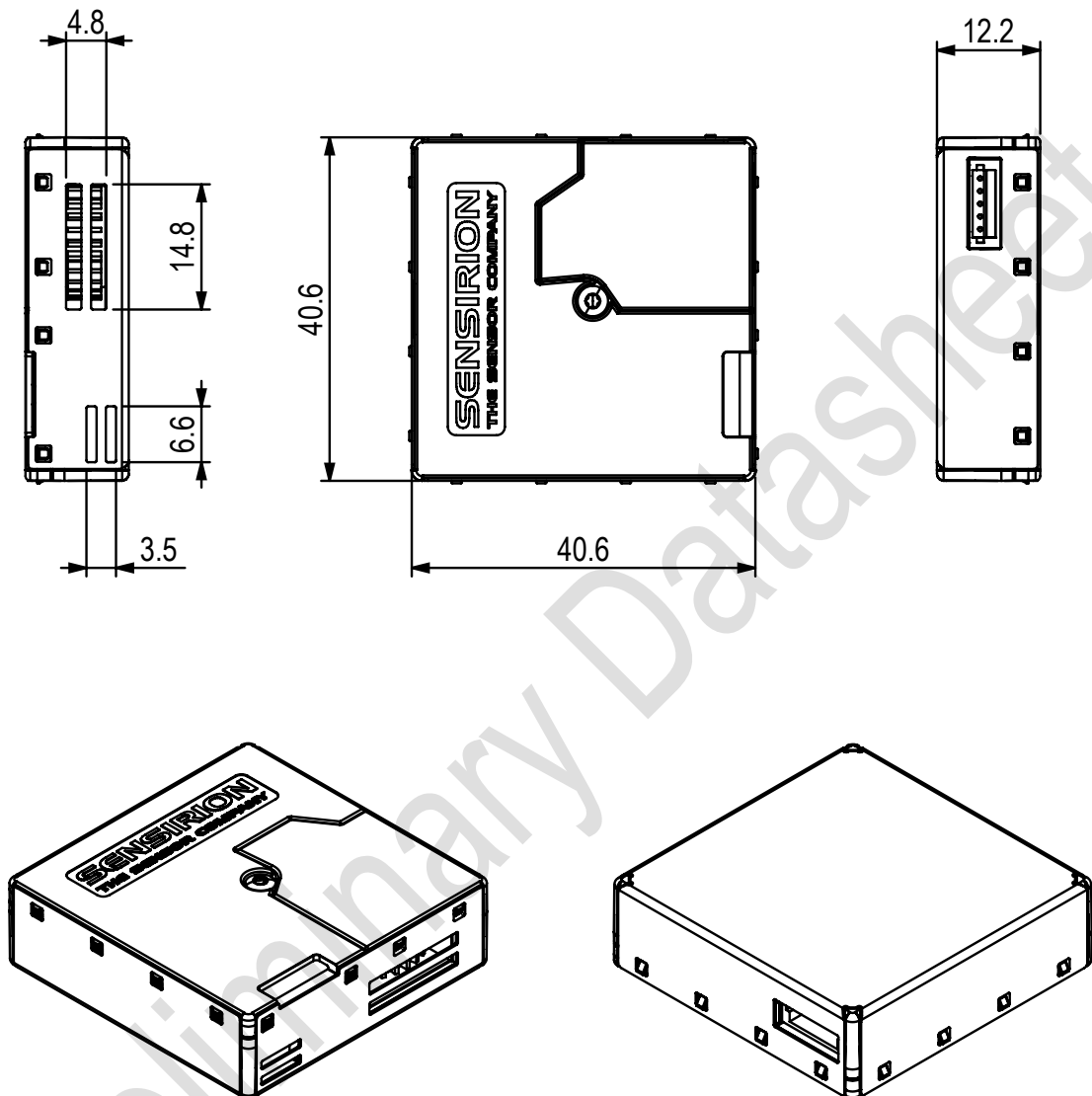

Figure 7: Package outline dimensions (given in mm) of the SPS30.

7 Important Notices

7.1 Warning, Personal Injury

Do not use this product as safety or emergency stop devices or in any other application where failure of the product could result in personal injury. Do not use this product for applications other than its intended and authorized use. Before installing, handling, using or servicing this product, please consult the data sheet and application notes. Failure to comply with these instructions could result in death or serious injury.

If the Buyer shall purchase or use SENSIRION products for any unintended or unauthorized application, Buyer shall defend, indemnify and hold harmless SENSIRION and its officers, employees, subsidiaries, affiliates and distributors against all claims, costs, damages and expenses, and reasonable attorney fees arising out of, directly or indirectly, any claim of personal injury or death associated with such unintended or unauthorized use, even if SENSIRION shall be allegedly negligent with respect to the design or the manufacture of the product.

7.2 ESD Precautions

The inherent design of this component causes it to be sensitive to electrostatic discharge (ESD). To prevent ESD-induced damage and/or degradation, take customary and statutory ESD precautions when handling this product.

7.3 Warranty

THIS PRODUCT IS NEITHER A QUALIFIED NOR A RELEASED PRODUCT. THE PRODUCT IS PROVIDED "AS IS" AND ANY EXPRESS OR IMPLIED WARRANTIES, INCLUDING, BUT NOT LIMITED TO, THE IMPLIED WARRANTIES OF MERCHANTABILITY AND FITNESS FOR A PARTICULAR PURPOSE ARE DISCLAIMED. IN NO EVENT SHALL SENSIRION OR CONTRIBUTORS BE LIABLE FOR ANY DIRECT, INDIRECT, INCIDENTAL, SPECIAL, EXEMPLARY, OR CONSEQUENTIAL DAMAGES OR INJURIES; PROCUREMENT OF SUBSTITUTE GOODS OR SERVICES; LOSS OF USE, DATA, OR PROFITS; OR BUSINESS INTERRUPTION HOWEVER CAUSED AND ON ANY THEORY OF LIABILITY, WHETHER IN CONTRACT, STRICT LIABILITY, OR TORT (INCLUDING NEGLIGENCE OR OTHERWISE) ARISING IN ANY WAY OUT OF THE USE OF THE PRODUCT, EVEN IF ADVISED OF THE POSSIBILITY OF SUCH DAMAGE.

Recommendations for use do not constitute a warranty, either express or implied, of the fitness or suitability of the product for a particular purpose. SENSIRION does not assume any liability arising out of any application or use of any product and specifically disclaims any and all liability, including without limitation consequential or incidental damages. The product shall only be left to such employees having been informed about the proper handling of the product and being qualified for its respective use.

No obligation or liability shall arise or grow out of SENSIRION's rendering of technical advice, consulting, support, recommendations, or advice in connection with the product and/or its use. All operating parameters, including without limitation recommended parameters, must be validated for each customer's applications by customer's technical experts. Recommended parameters can and do vary in different applications.

SENSIRION reserves the right, without further notice, to change the product specifications and/or the information in this document.

Copyright© 2017, by SENSIRION.
CMOSens® is a trademark of Sensirion
All rights reserved

8 Headquarters and Subsidiaries

Sensirion AG

Laubisruestr. 50
CH-8712 Staefa ZH
Switzerland

phone: +41 44 306 40 00

fax: +41 44 306 40 30

info@sensirion.com

www.sensirion.com

Sensirion Taiwan Co. Ltd

phone: +886 3 5506701

info@sensirion.com

www.sensirion.com

Sensirion Inc., USA

phone: +1 312 690 5858

info-us@sensirion.com

www.sensirion.com

Sensirion Japan Co. Ltd.

phone: +81 3 3444 4940

info-jp@sensirion.com

www.sensirion.co.jp

Sensirion Korea Co. Ltd.

phone: +82 31 337 7700~3

info-kr@sensirion.com

www.sensirion.co.kr

Sensirion China Co. Ltd.

phone: +86 755 8252 1501

info-cn@sensirion.com

www.sensirion.com.cn

To find your local representative, please visit www.sensirion.com/distributors