

CRD1615A-8W

8 Watt Reference Design

Features

- Supports Cirrus Logic CS1615A
- Reduced BOM Cost Compared to CS1615
- Isolated Flyback Topology with Constant-current Output
- Flicker-free Dimming
- <1% Minimum Dimming Across a Broad Range of Dimmers
- Line Voltage 108VAC - 132VAC
- Rated Output Power: 7.5W
- Efficiency: ~82% at 250mA for 10×LEDs in Series
- Power Factor >0.99

General Description

The CRD1615A-8W reference design demonstrates the performance of the CS1615A single stage dimmable AC/DC LED driver IC with a 250mA output driving 10×LEDs in series. The CS1615A is designed to support a reduced off-chip BOM compared to the CS1615. It offers best-in-class dimmer compatibility and minimum dimming performance with leading-edge, trailing-edge, and digital dimmers. The form factor is targeted to fit into many LED bulb applications (GU10, A19-type, PAR, BR).

DIMENSIONS (OVERALL)

Length	Width	Height
2.028" (51.5mm)	1.004" (25.5mm)	0.65" (16.5mm)

For more information, see Figure 3 on page 6.

ORDERING INFORMATION

CRD1615A-8W-Z	8 Watt Reference Design Supports CS1615A
---------------	---

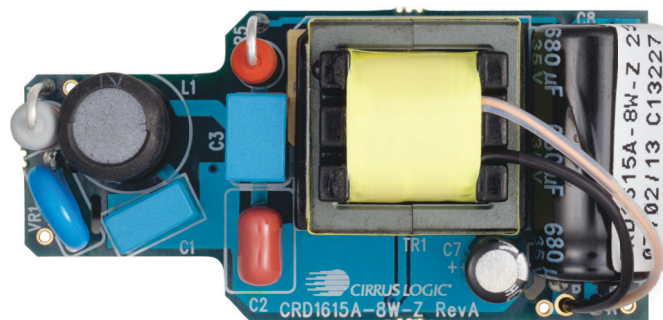

Top

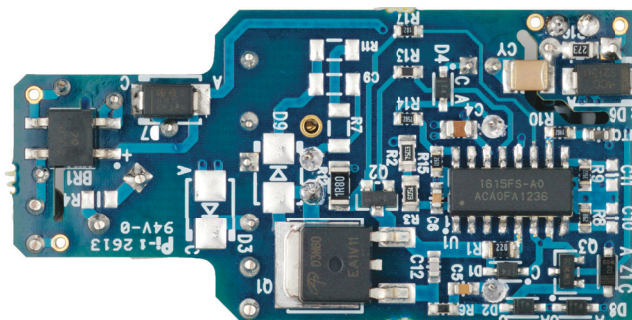

Bottom



IMPORTANT SAFETY INSTRUCTIONS

Read and follow all safety instructions prior to using this demonstration board.

This Engineering Evaluation Unit or Demonstration Board must only be used for assessing IC performance in a laboratory setting. This product is not intended for any other use or incorporation into products for sale.

This product must only be used by qualified technicians or professionals who are trained in the safety procedures associated with the use of demonstration boards.

⚠ DANGER Risk of Electric Shock

- The direct connection to the AC power line and the open and unprotected boards present a serious risk of electric shock and can cause serious injury or death. Extreme caution needs to be exercised while handling this board.
- Avoid contact with the exposed conductor or terminals of components on the board. High voltage is present on exposed conductor and it may be present on terminals of any components directly or indirectly connected to the AC line.
- Dangerous voltages and/or currents may be internally generated and accessible at various points across the board.
- Charged capacitors store high voltage, even after the circuit has been disconnected from the AC line.
- Make sure that the power source is off before wiring any connection. Make sure that all connectors are well connected before the power source is on.
- Follow all laboratory safety procedures established by your employer and relevant safety regulations and guidelines, such as the ones listed under, OSHA General Industry Regulations - Subpart S and NFPA 70E.

⚠ WARNING Suitable eye protection must be worn when working with or around demonstration boards. Always comply with your employer's policies regarding the use of personal protective equipment.

⚠ WARNING All components and metallic parts may be extremely hot to touch when electrically active.

Contacting Cirrus Logic Support

For all product questions and inquiries contact a Cirrus Logic Sales Representative. To find the one nearest to you go to www.cirrus.com

IMPORTANT NOTICE

Cirrus Logic, Inc. and its subsidiaries ("Cirrus") believe that the information contained in this document is accurate and reliable. However, the information is subject to change without notice and is provided "AS IS" without warranty of any kind (express or implied). Customers are advised to obtain the latest version of relevant information to verify, before placing orders, that information being relied on is current and complete. All products are sold subject to the terms and conditions of sale supplied at the time of order acknowledgment, including those pertaining to warranty, indemnification, and limitation of liability. No responsibility is assumed by Cirrus for the use of this information, including use of this information as the basis for manufacture or sale of any items, or for infringement of patents or other rights of third parties. This document is the property of Cirrus and by furnishing this information, Cirrus grants no license, express or implied under any patents, mask work rights, copyrights, trademarks, trade secrets or other intellectual property rights. Cirrus owns the copyrights associated with the information contained herein and gives consent for copies to be made of the information only for use within your organization with respect to Cirrus integrated circuits or other products of Cirrus. This consent does not extend to other copying such as copying for general distribution, advertising or promotional purposes, or for creating any work for resale.

CERTAIN APPLICATIONS USING SEMICONDUCTOR PRODUCTS MAY INVOLVE POTENTIAL RISKS OF DEATH, PERSONAL INJURY, OR SEVERE PROPERTY OR ENVIRONMENTAL DAMAGE ("CRITICAL APPLICATIONS"). CIRRUS PRODUCTS ARE NOT DESIGNED, AUTHORIZED OR WARRANTED FOR USE IN PRODUCTS SURGICALLY IMPLANTED INTO THE BODY, AUTOMOTIVE SAFETY OR SECURITY DEVICES, LIFE SUPPORT PRODUCTS OR OTHER CRITICAL APPLICATIONS. INCLUSION OF CIRRUS PRODUCTS IN SUCH APPLICATIONS IS UNDERSTOOD TO BE FULLY AT THE CUSTOMER'S RISK AND CIRRUS DISCLAIMS AND MAKES NO WARRANTY, EXPRESS, STATUTORY OR IMPLIED, INCLUDING THE IMPLIED WARRANTIES OF MERCHANTABILITY AND FITNESS FOR PARTICULAR PURPOSE, WITH REGARD TO ANY CIRRUS PRODUCT THAT IS USED IN SUCH A MANNER. IF THE CUSTOMER OR CUSTOMER'S CUSTOMER USES OR PERMITS THE USE OF CIRRUS PRODUCTS IN CRITICAL APPLICATIONS, CUSTOMER AGREES, BY SUCH USE, TO FULLY INDEMNIFY CIRRUS, ITS OFFICERS, DIRECTORS, EMPLOYEES, DISTRIBUTORS AND OTHER AGENTS FROM ANY AND ALL LIABILITY, INCLUDING ATTORNEYS' FEES AND COSTS, THAT MAY RESULT FROM OR ARISE IN CONNECTION WITH THESE USES.

Cirrus Logic, Cirrus, the Cirrus Logic logo designs, EXL Core, and the EXL Core logo design are trademarks of Cirrus Logic, Inc. All other brand and product names in this document may be trademarks or service marks of their respective owners.

1. INTRODUCTION

The CS1615A is a 120VAC quasi-resonant flyback mode dimmable LED controller IC. The CS1615A uses a digital control algorithm that is optimized for high efficiency and > 0.99 power factor over an input voltage range (108VAC to 132VAC). The CS1615A integrates a dimmer compatibility circuit with a constant output current, quasi-resonant flyback stage. An adaptive dimmer compatibility algorithm controls the dimmer compatibility operation mode to enable flicker-free operation from 0% to 100% output current with leading-edge, trailing-edge, and digital dimmers.

The CRD1615A-8W board is optimized to deliver low system cost in a high-efficiency, flicker-free, phase-dimmable, solid-state lighting (SSL) solution for incandescent lamp replacement applications. The feedback loop is closed through an integrated digital control system within the IC. Protection algorithms such as output open/short, current-sense resistor open/short, and overtemperature thermistors protect the system during abnormal conditions. When using the CS1615A for a design that does not require active clamp circuitry, the CLAMP pin should be left floating. Details of these features are provided in the CS1615A/16A data sheet DS1033 *Single Stage Dimmable Controller for LED Lamps*.

The CRD1615A-8W board demonstrates the performance of the CS1615A. This reference board has been designed for an output load of 10×LEDs in series at 250mA (~30.0V typical).

This data sheet provides the schematic and PCB layout for the reference design board. The performance graphs demonstrate the performance of the CS1615A dimmable-controller reference design in terms of Efficiency vs. Line Voltage, Power Factor vs. Line Voltage, THD vs. Line Voltage, Output Current vs. Line Voltage, and Output Current vs. Dim Angle.

Extreme caution needs to be exercised while handling this board. This board is to be used by trained professionals only.

2. SCHEMATIC

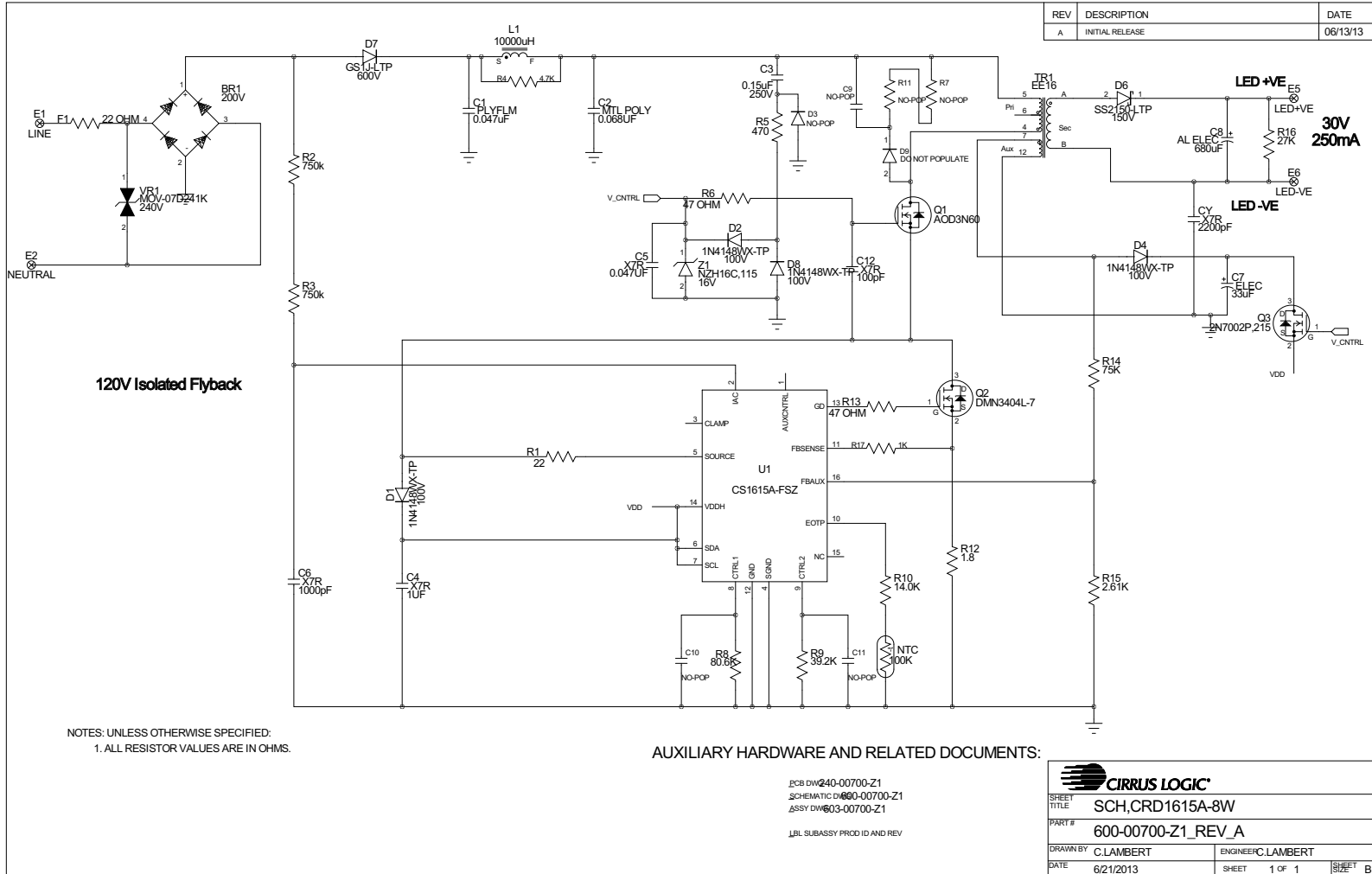

Figure 1. Schematic

3. BILL OF MATERIALS

Item	Rev	Description	Qty	Reference Designator	MFG	MFG P/N
1		DIODE RECT 200V 0.8A NPb MINIDIP	1	BR1	DIODES INC	HD02-T
2		CAP 0.047uF ±5% 250V POLY NPb RAD	1	C1	EPCOS	B32529C3473J
3		CAP 0.068uF ±10% 250V MPOLY NPb RAD	1	C2	PANASONIC	ECQE2683KB
4		CAP 0.15uF ±10% 250V POLY NPb RAD	1	C3	EPCOS	B32529C3154K
5		CAP 1uF ±10% 25V X7R NPb 0805	1	C4	TDK	C2012X7R1E105K125AB
6	A	CAP 0.047uF ±10% 25V X7R NPb 0603	1	C5	KEMET	CO603C473K3RAC
7	A	CAP 1000pF ±10% 50V X7R 0603	1	C6	KEMET	CO603C102K5RAC
8		CAP 33uF ±20% 35V ALUM ELEC NPb RAD	1	C7	PANASONIC	ECA1VHG330
9		CAP 680uF ±20% 35V AL ELEC NPb RAD	1	C8	PANASONIC	EEUFR1V681
10		CAP 220pF ±10% 600V X7R NPb1206	0	C9	AVX	1206CC221KAT1A
11		CAP 56pF ±5% 50V COG NPb 0603	0	C10 C11	KEMET	CO603C560J5GAC
12		CAP 100pF ±10% 50V X7R CER NPb 0603	1	C12	TDK	C1608X7R1H101K
13		CAP 2200pF ±10% 2KV X7R NPb 1210	1	CY	JOHANSON DIELECTRICS	202S41W222KV4E
14		DIODE HS SWT 100V 150mA NPb SOD323	4	D1 D2 D4 D8	MICRO COMMERCIAL	1N4148WX-TP
15		DIODE 600V 1A NPb SMA DO-214AC	1	D3 D7	MCC	GS1J-LTP
16		DIODE SKY RECT 150V 2A NPb DO-214AC	1	D6	MCC	SS2150-LTP
17		DIODE ULT FAST 600V 1A NPb SMA	0	D9	ST MICROELECTRONICS	STTH1L06A
18		RES 22 OHM 2W ±10% MTLFLM NPb AXIAL	1	F1	TT ELECTRONICS	EMC2-22RKI
19		IND 10000uH 0.053A MINI-DRUM NPb TH	1	L1	RENCO	RL-5480-3-10000
20		THERM 100K OHM ±5% 0.10mA NPb 0603	1	NTC	MURATA	NCP18WF104J03RB
21		TRAN MOSFET nCH 2.5A 600V NPb DPAK	1	Q1	ALPHA & OMEGA	AOD3N60
22		TRAN MOSFET nCH 30V 5.8A NPb SOT23	1	Q2	DIODES INC	DMN3404L-7
23		TRAN MSFET nCH 60V 360mA NPb SOT-23	1	Q3	NXP	2N7002P,215
24		RES 22 OHM 1/8W ±5% NPb 0805 FILM	1	R1	DALE	CRCW080522R0JNEA
25		RES 750k OHM 1/8W ±1% NPb 0805 FILM	2	R2 R3	PANASONIC	ERJ6ENF7503V
26		RES 4.7k OHM 1/8W ±5% NPb 0805 FILM	0	R4	DALE	CRCW08054K70JNEA
27		RES 470 OHM 2W ±5% MTL FLM NPb AXL	1	R5	VISHAY	PR02000204700JR500
28		RES 47 OHM 1/10W ±1% NPb 0603	2	R6 R13	PANASONIC	ERJ3EKF47R0V
29		RES 10k OHM 1/4W ±1% NPb 1206 FILM	0	R7 R11	DALE	CRCW120610K0FKEA
30		RES 80.6k OHM 1/10W ±1% 0603 FILM	1	R8	DALE	CRCW060380K6FKEA
31		RES 39.2k OHM 1/10W ±1% NPb 0603	1	R9	DALE	CRCW060339K2FKEA
32		RES 14k OHM 1/10W ±1% NPb 0603 FILM	1	R10	DALE	CRCW060314K0FKEA
33		RES 1.8 OHM 1/4W ±1% NPb 1206 FILM	1	R12	DALE	CRCW12061R80FKEA
34		RES 75k OHM 1/10W ±1% NPb 0603 FILM	1	R14	DALE	CRCW060375K0FKEA
35		RES 2.61k OHM 1/10W ±1% NPb 0603	1	R15	DALE	CRCW06032K61FKEA
36		RES 27K OHM 1/8W ±0.1% NPb 0805	1	R16	PANASONIC	ERA-6YEB273V
37		RES 1k OHM 1/10W ±5% NPb 0603 FILM	1	R17	DALE	CRCW06031K00JNEA
38		XFMR 0.9mH ±10% 10KHz NPb TH	1	TR1	KUNSHAN EAGERNESS	EF16-CL011M
39	B1	IC CRUS TRIAC DIM PFC 120V NPb SO16	1	U1	CIRRUS LOGIC	CS1615A-FSZ/B1
40		VARISTOR 240V 210pF 15J 7mm NPb RAD	1	VR1	BOURNS	MOV-07D241K
41		DIODE ZENER 500mW 16V NPb SOD123F	1	Z1	NXP	NZH16C,115

Figure 2. Bill of Materials

4. BOARD LAYOUT

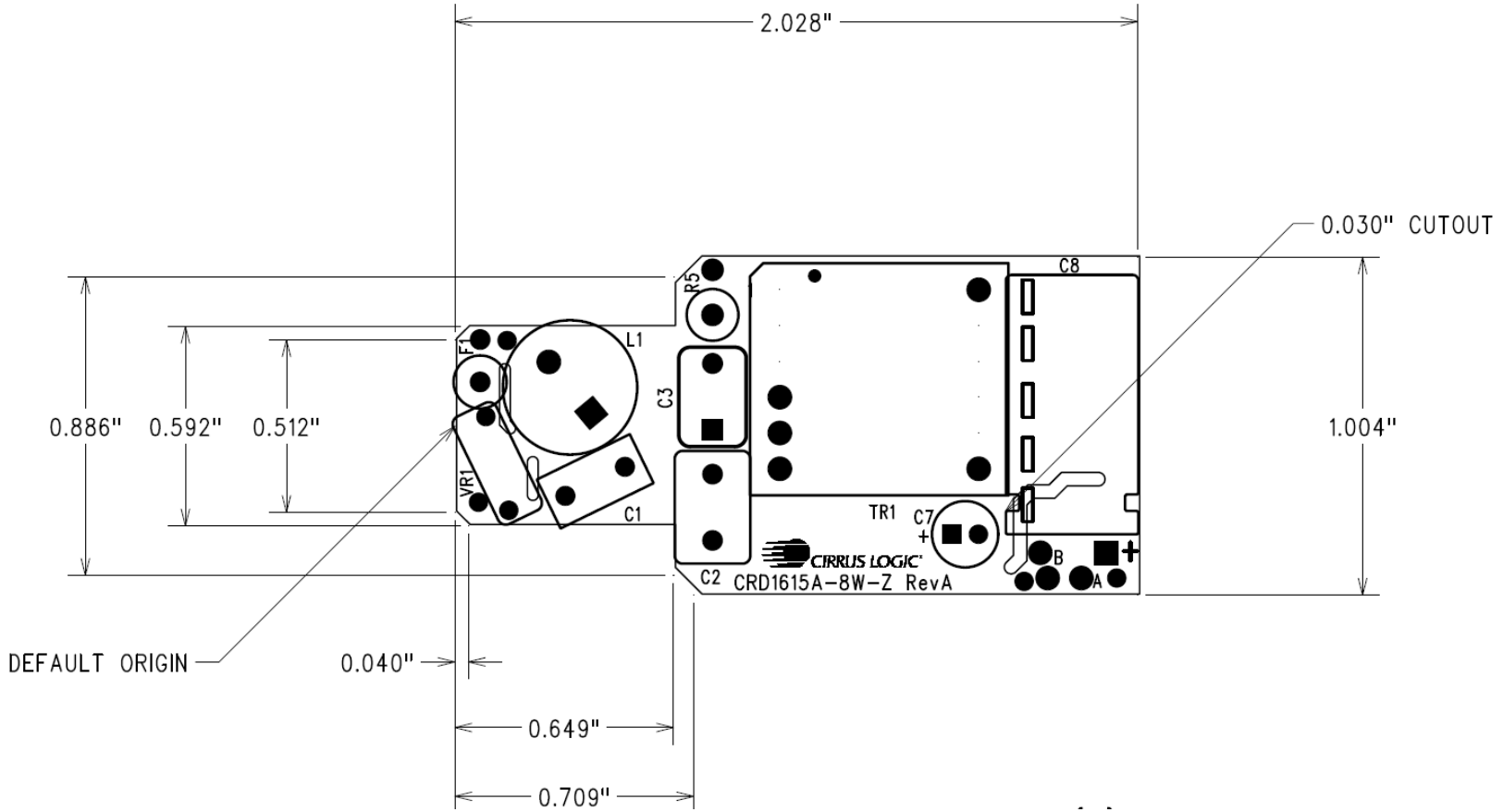

Figure 3. PCB Dimensions

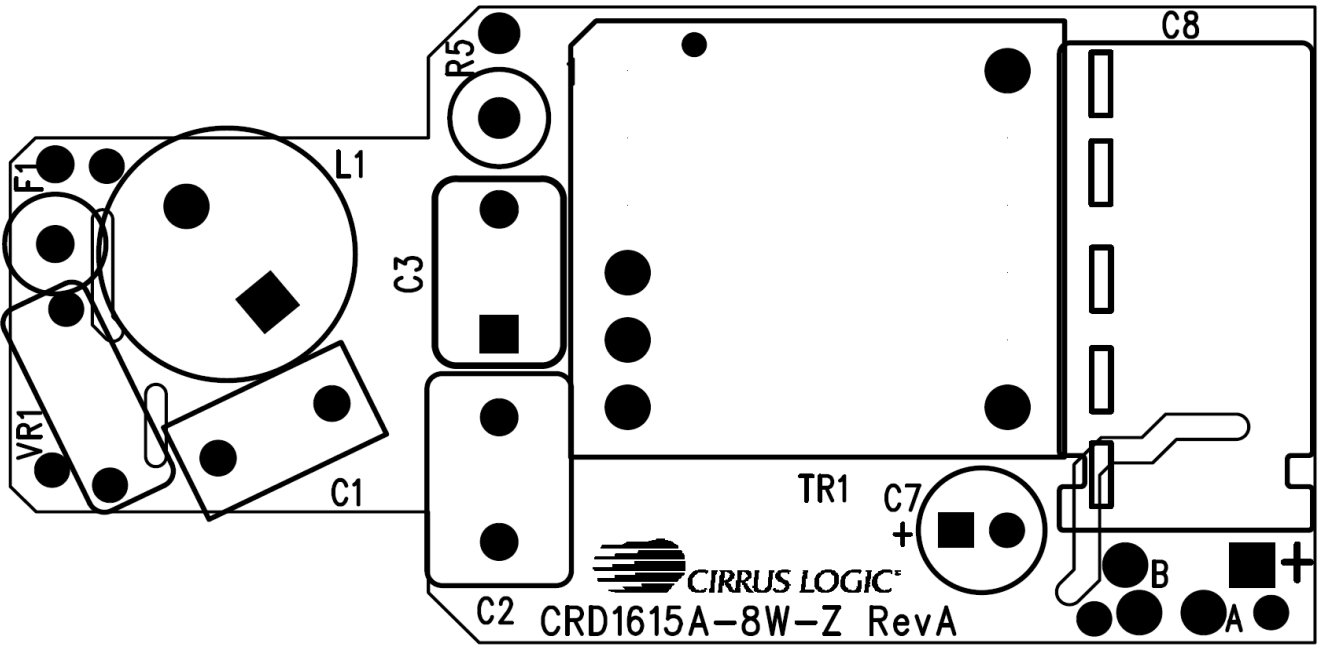

Figure 4. Top Silkscreen

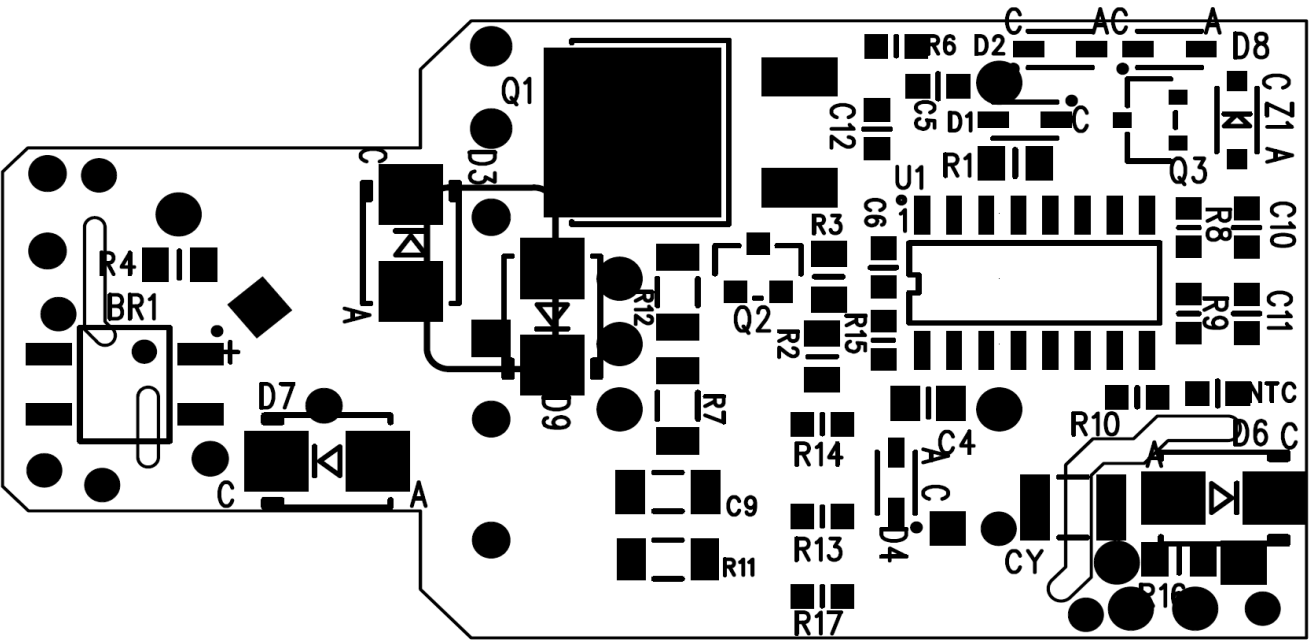

Figure 5. Bottom Silkscreen

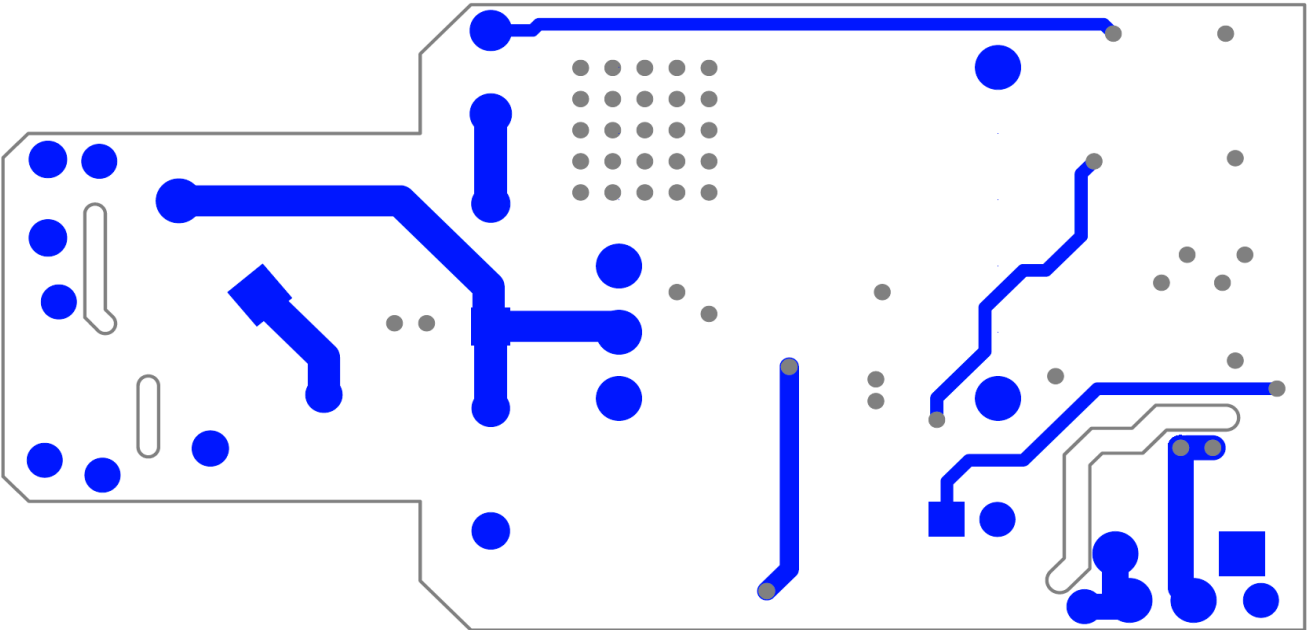

Figure 6. Top Routing

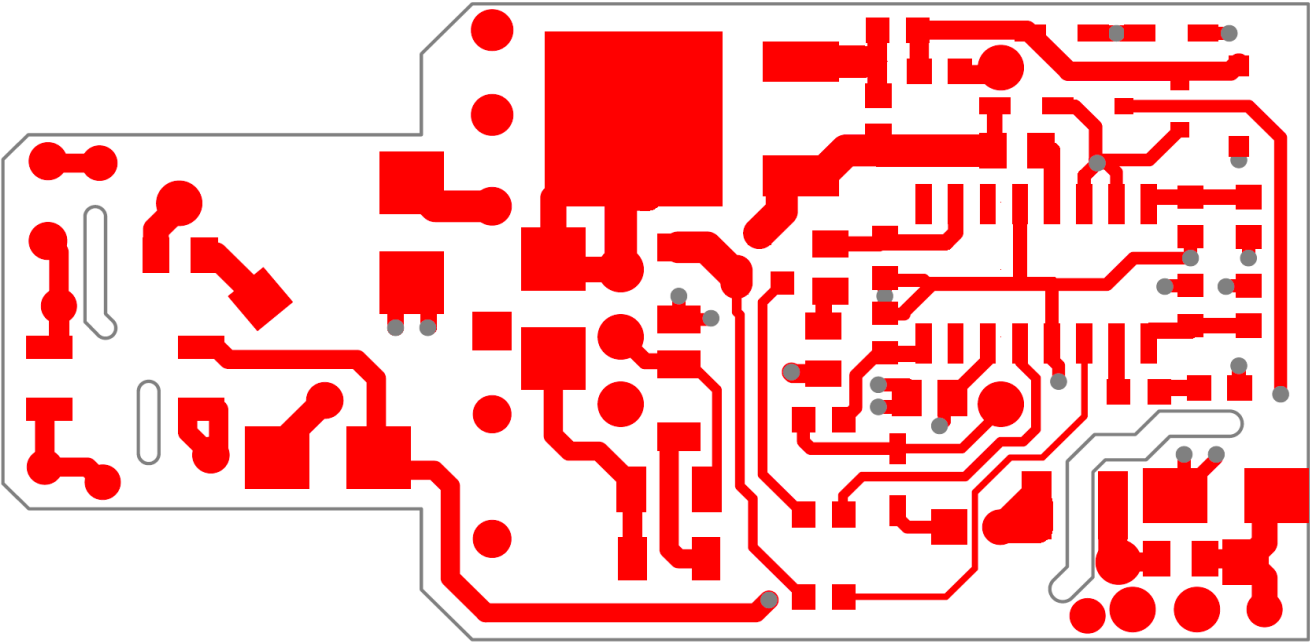

Figure 7. Bottom Routing

5. THERMAL IMAGING

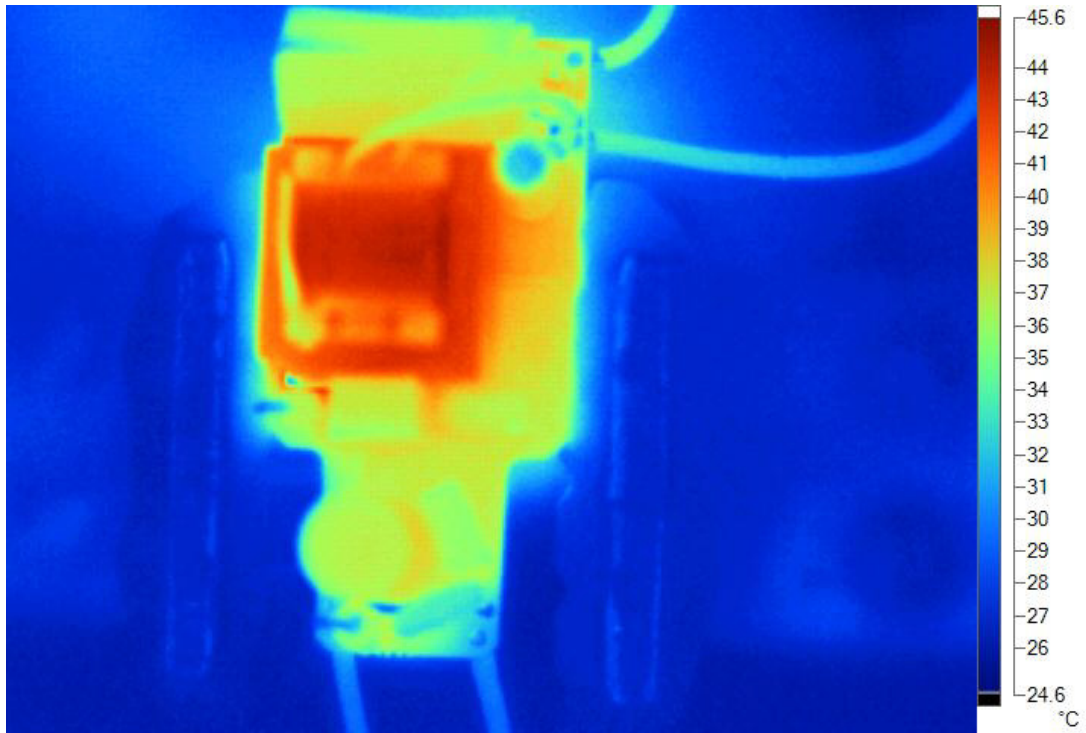

Figure 8. Top Thermal

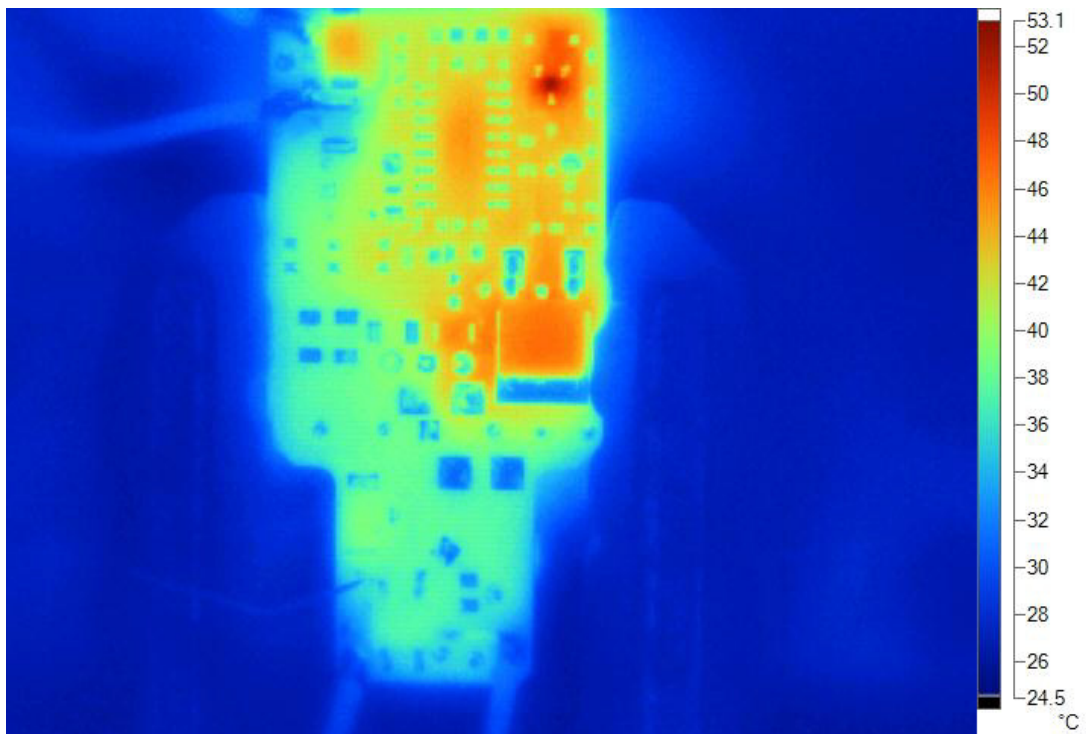

Figure 9. Bottom Thermal

6. DIMMER COMPATIBILITY
A19 Lamp with a CS1615A (120V/60Hz)

Date	8/12/2013	Power Factor^{1,4}	0.994
Vendor	Cirrus Logic	EN55015 Compliant (Y/N)	Y
Input Voltage	120V/60Hz	Nominal Input Power (W)^{1,4}	9.0
Form Factor	A19	Maximum Input Power (W)^{1,4}	9.0
Model #	CRD1615A-8W	Output Voltage (V)^{1,2}	29.9
IC	CS1615A	Output Current (mA)^{1,2}	247
Topology	Flyback	Output Current Ripple \leq 120Hz (mA)^{1,3}	200
Isolation (Y/N)	Y	Output Power (W)^{1,4}	7.385
Efficiency (%)	81.7		

Dimmer ⁵		Flicker Free Steady-State			Monotonic Dimming			Max I _{out} (%)			Min I _{out} (%)		
Manufacture	Type	# of lamps			# of lamps			# of lamps			# of lamps		
		1	5	10	1	5	10	1	5	10	1	5	10
Cooper 6001	Leading Edge	Y	Y	Y	Y	Y	Y	100.0	100.0	98.8	0.4	0.4	0.4
Cooper 9530	Leading Edge	Y	Y	Y	Y	Y	Y	100.4	100.4	99.6	0.4	0.4	0.4
Cooper DI06P	Leading Edge	Y	Y	Y	Y	Y	Y	100.0	100.0	98.8	0.4	0.4	0.4
GE 52136	Leading Edge	N	Y	Y	Y	Y	Y	100.0	100.0	98.8	0.4	0.4	0.4
GE IRIS 45639	Leading Edge	Y	Y	Y	Y	Y	Y	100.0	99.6	98.8	0.4	0.4	0.4
Legrand ADPD703HW4	Leading Edge	Y	Y	Y	Y	Y	Y	100.0	100.0	98.8	0.4	0.4	0.4
Legrand ADTP703UM4	Leading Edge	Y	Y	Y	Y	Y	Y	100.4	100.4	99.2	0.4	0.4	0.4
Leviton 6161	Leading Edge	N	Y	N	Y	Y	Y	99.2	98.8	98.8	0.4	0.8	0.4
Leviton 6613	Leading Edge	Y	Y	Y	Y	Y	Y	100.0	100.0	98.8	0.4	0.4	0.4
Leviton 6615	Trailing Edge	Y	Y	Y	Y	Y	Y	99.6	99.2	98.0	0.4	0.4	0.4
Leviton 6627	Leading Edge	Y	Y	Y	Y	Y	Y	89.9	89.9	91.5	3.2	2.4	2.4
Leviton 6631	Leading Edge	Y	Y	Y	Y	Y	Y	100.0	100.0	98.8	0.4	0.4	0.4
Leviton 6641	Leading Edge	Y	Y	Y	Y	Y	Y	99.6	98.0	98.4	0.4	0.4	0.4
Leviton 6683	Leading Edge	Y	Y	Y	Y	Y	Y	100.0	100.0	98.8	0.4	0.4	0.4
Leviton 6684	Leading Edge	Y	Y	Y	Y	Y	Y	100.0	100.0	98.8	0.4	0.4	0.4
Leviton 700	Leading Edge	Y	Y	Y	Y	Y	Y	100.0	100.0	98.8	0.4	0.4	0.4
Leviton ACE04	Trailing Edge	Y	Y	Y	Y	Y	N	99.6	99.6	98.4	0.4	0.4	0.4
Leviton ACM06	Leading Edge	Y	Y	Y	Y	Y	Y	99.6	99.6	98.8	0.4	0.4	0.4
Leviton ACX10	Leading Edge	Y	N	Y	Y	Y	N	99.6	14.6	10.1	4.5	0.8	0.4
Leviton HCM06	Leading Edge	Y	Y	Y	Y	Y	Y	100.0	100.0	99.2	0.4	0.4	0.4
Leviton IPI06-1L	Leading Edge	Y	Y	Y	Y	Y	Y	100.0	100.0	98.8	0.4	0.4	0.4
Leviton VZM06	Leading Edge	Y	Y	Y	Y	Y	Y	99.6	99.6	98.8	0.8	0.4	0.4
Lutron AB-600M	Leading Edge	Y	Y	Y	Y	Y	Y	93.9	94.3	95.1	0.4	0.4	0.4

Dimmer ⁵		Flicker Free Steady-State			Monotonic Dimming			Max I _{out} (%)			Min I _{out} (%)		
Manufacture	Type	# of lamps			# of lamps			# of lamps			# of lamps		
		1	5	10	1	5	10	1	5	10	1	5	10
Lutron AY-600P	Leading Edge	Y	Y	Y	Y	Y	Y	98.8	97.2	98.8	0.4	0.4	0.4
Lutron CT-600P	Leading Edge	Y	N	Y	Y	Y	Y	97.6	97.2	98.4	0.4	0.4	0.4
Lutron CT-603PG	Leading Edge	N	Y	Y	Y	Y	Y	81.0	83.0	79.8	0.4	0.4	0.4
Lutron CTCL-153P	Leading Edge	Y	Y	Y	Y	Y	Y	95.5	94.7	95.5	0.4	0.4	0.4
Lutron DV-600P	Leading Edge	Y	Y	Y	Y	Y	Y	98.4	98.4	98.4	0.4	0.4	0.4
Lutron DVCL-153P	Leading Edge	Y	Y	Y	Y	Y	Y	95.5	96.0	96.8	0.4	0.4	0.4
Lutron DVELV-300P	Trailing Edge	Y	Y	Y	N	N	N	88.3	85.8	86.6	0.4	0.4	0.4
Lutron DVW-603PG	Leading Edge	Y	Y	Y	Y	Y	Y	80.6	82.6	79.8	0.4	0.4	0.4
Lutron GL-600P	Leading Edge	Y	Y	Y	Y	Y	Y	96.8	96.8	97.6	0.4	0.4	0.4
Lutron LG-103P	Leading Edge	Y	Y	Y	Y	Y	Y	98.0	97.6	98.4	0.4	0.4	0.4
Lutron MACL-153M	Leading Edge	Y	Y	Y	Y	Y	Y	91.1	90.7	91.1	0.4	0.4	0.4
Lutron MAW-600	Leading Edge	Y	Y	Y	Y	Y	Y	97.2	97.2	98.4	0.4	0.4	0.4
Lutron MIR-600	Leading Edge	Y	Y	Y	Y	Y	Y	96.8	97.2	98.0	0.4	0.4	0.4
Lutron NT2000	Leading Edge	Y	Y	Y	Y	Y	Y	94.7	94.3	96.0	0.4	0.4	0.4
Lutron NTELV-600	Trailing Edge	Y	Y	Y	N	N	N	92.7	92.3	92.7	0.4	0.4	0.4
Lutron NTLV-600	Leading Edge	Y	Y	Y	Y	Y	Y	100.0	100.0	98.8	0.4	0.4	0.4
Lutron Q-603P	Leading Edge	Y	Y	Y	Y	Y	Y	98.4	98.4	98.4	0.4	0.4	0.4
Lutron S-103P	Leading Edge	Y	Y	Y	Y	Y	Y	98.4	97.6	98.4	0.4	0.4	0.4
Lutron S-600P	Leading Edge	Y	N	Y	Y	Y	Y	98.0	97.6	98.4	0.4	0.4	0.4
Lutron SELV-303P	Trailing Edge	Y	Y	Y	N	N	N	89.5	86.6	87.9	0.4	0.4	0.4
Lutron SLV-600P	Leading Edge	N	N	Y	Y	Y	Y	98.8	98.8	98.8	0.4	0.4	0.4
Lutron SLV-603P	Leading Edge	Y	Y	Y	Y	Y	Y	99.2	98.8	98.8	0.4	0.4	0.4
Lutron SPS-600	Leading Edge	Y	Y	Y	Y	Y	Y	98.8	98.8	98.8	0.4	0.4	0.4
Lutron SPSLV-1000	Leading Edge	Y	Y	Y	Y	Y	Y	99.6	99.2	98.8	0.4	0.4	0.4
Lutron TG-600P	Leading Edge	Y	Y	Y	Y	Y	Y	99.6	100.0	98.8	0.4	0.4	0.4
Lutron TG-603PG	Leading Edge	Y	N	Y	Y	Y	Y	83.8	83.8	85.4	0.4	0.4	0.4
Lutron TGCL-153P	Leading Edge	Y	Y	Y	Y	Y	Y	98.0	97.2	98.0	0.4	0.4	0.4
Smarthome 2486D	Leading Edge	Y	Y	Y	Y	Y	Y	100.0	99.6	98.8	0.4	0.4	0.4

1. Tested at nominal input voltage, nominal input frequency and without a dimmer after soaking for 15 minutes
2. Average
3. Peak-to-peak
4. Measured with Chroma 66202 Power Analyze
5. This document includes trademarks, trade names, brands, logos, product names and/or product identifiers of companies other than Cirrus Logic, Inc. All such trademarks, trade names, brands, logos, product names, and product identifiers are for identification purposes only and are the property of their respective owners, who are not affiliated with Cirrus Logic. Please visit the respective sites of those owners to obtain a listing or understanding of their trademark rights. This document also includes results from testing performed by Cirrus Logic for its own purposes and for which there are currently no industry standards. While this testing was applied objectively, its results may include at least some degree of subjectivity. The testing or test results should not be interpreted as any comment on the overall quality or suitability of any tested products

7. TRANSFORMER CONSTRUCTION

The CRD1615A-8W provides power factor correction and dimmer compatibility with a constant output current, quasi-resonant flyback stage. The following sections describe the flyback transformer installed on the CRD1615A-8W.

7.1 Flyback Transformer

The flyback transformer stage is a quasi-resonant peak current-regulated DC-DC converter capable of delivering the highest possible efficiency with constant current output while minimizing line frequency ripple. The auxiliary winding is used for zero-current detection and overvoltage protection.

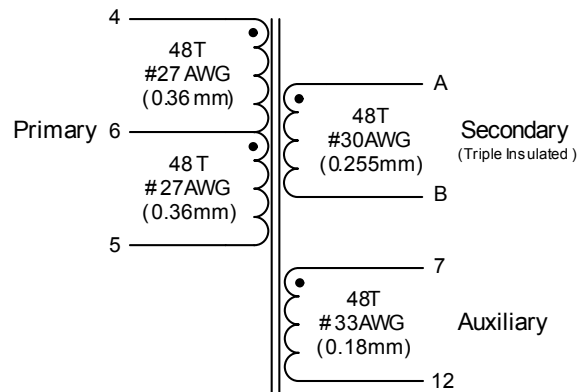

Figure 10. Flyback Transformer Schematic

7.1.1 Electrical Specifications

Characteristics conditions:

- Operating temperature range: -25 °C to +120 °C (including coil heat)

Parameter	Condition	Symbol	Min	Typ	Max	Unit
Flyback Transformer						
Electrical Strength (Note 1)	$f_{\text{operate}}=50/60\text{Hz}$		-	3.75	-	kV _{RMS}
Primary Inductance (Note 2)	$f_{\text{resonant}}=10\text{kHz}$, 0.3V at 20°C	L_P	0.8	0.9	1.0	mH
Primary Leakage Inductance (Note 2)	$f_{\text{resonant}}=10\text{kHz}$, 0.3V at 20°C	L_K	-	-	20	μH
Primary DC Resistance (Note 2)	$t_{\text{DCR}}=20^\circ\text{C}$		1.9	2.2	2.5	Ω
Secondary DC Resistance (Note 3)	$t_{\text{DCR}}=20^\circ\text{C}$		0.8	1.0	1.2	mΩ
Auxiliary DC Resistance (Note 4)	$t_{\text{DCR}}=20^\circ\text{C}$		3.0	3.5	4.0	mΩ

- Notes:
1. Time = 2sec.
 2. Measured across pins 4 and 5
 3. Measured across pins B and A
 4. Measured across pins 12 and 7

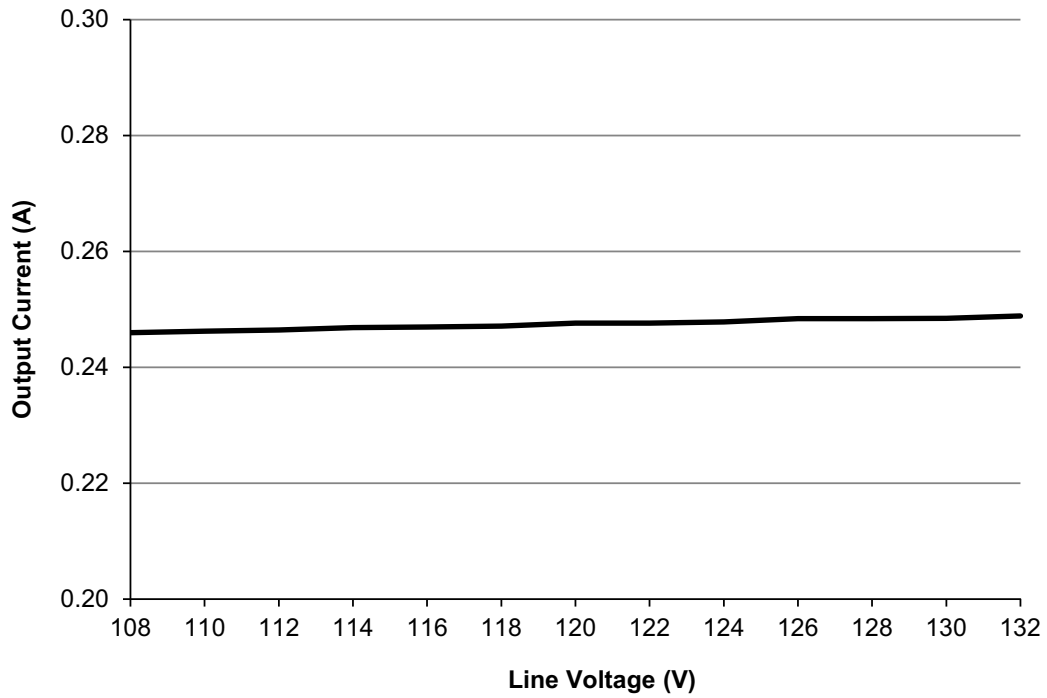
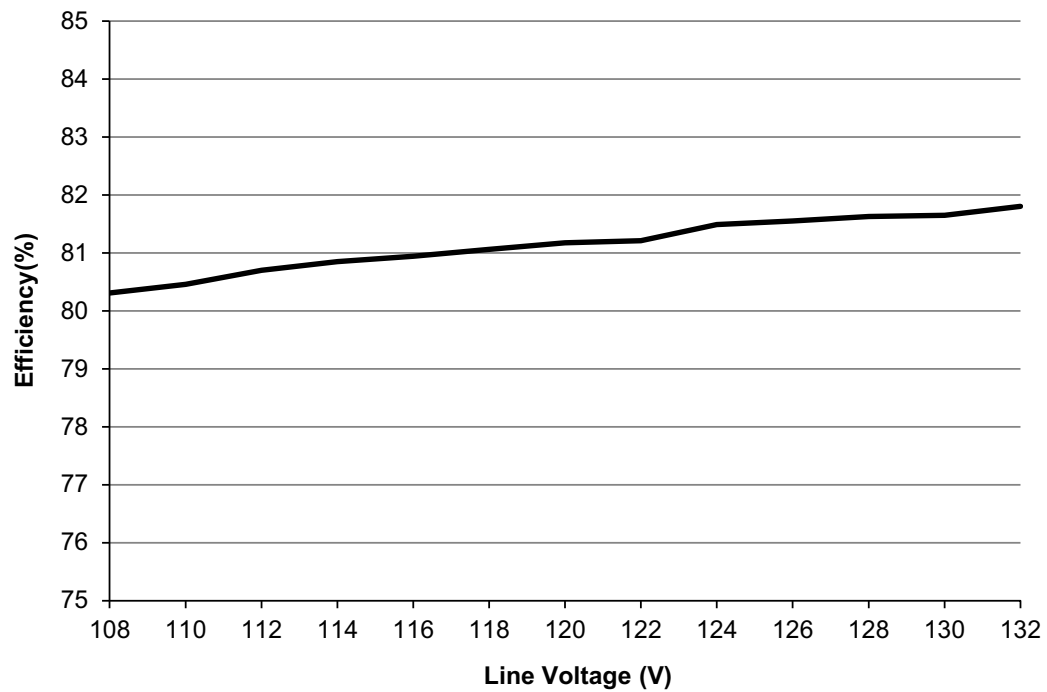
8. PERFORMANCE PLOTS

Figure 11. Output Current vs. Line Voltage

Figure 12. Typical Efficiency vs. Line Voltage

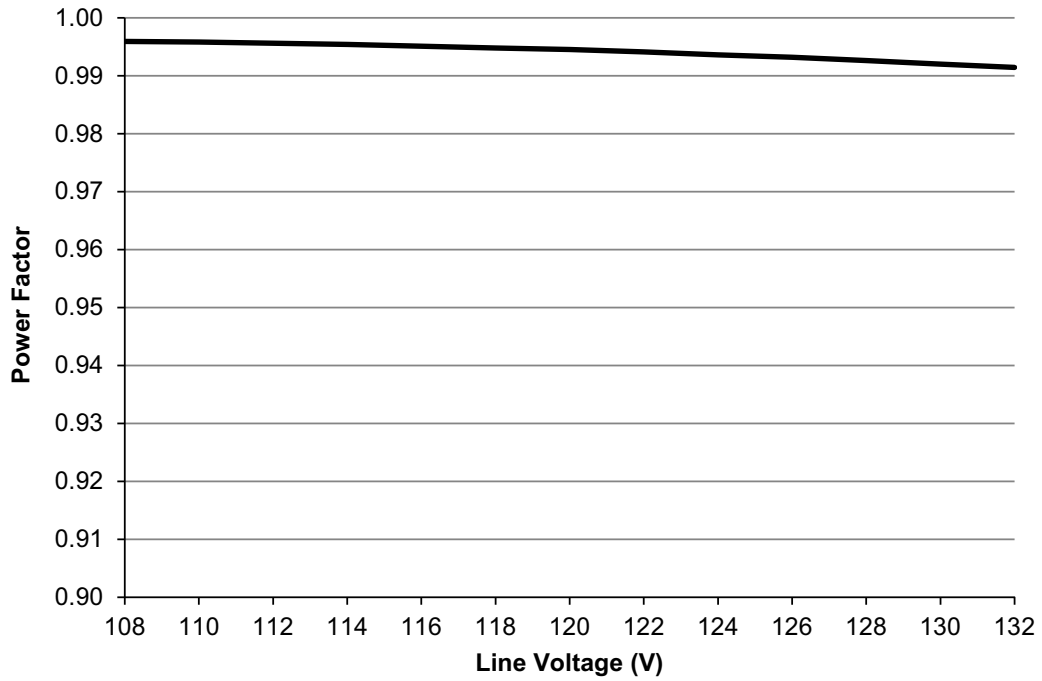

Figure 13. Power Factor vs. Line Voltage

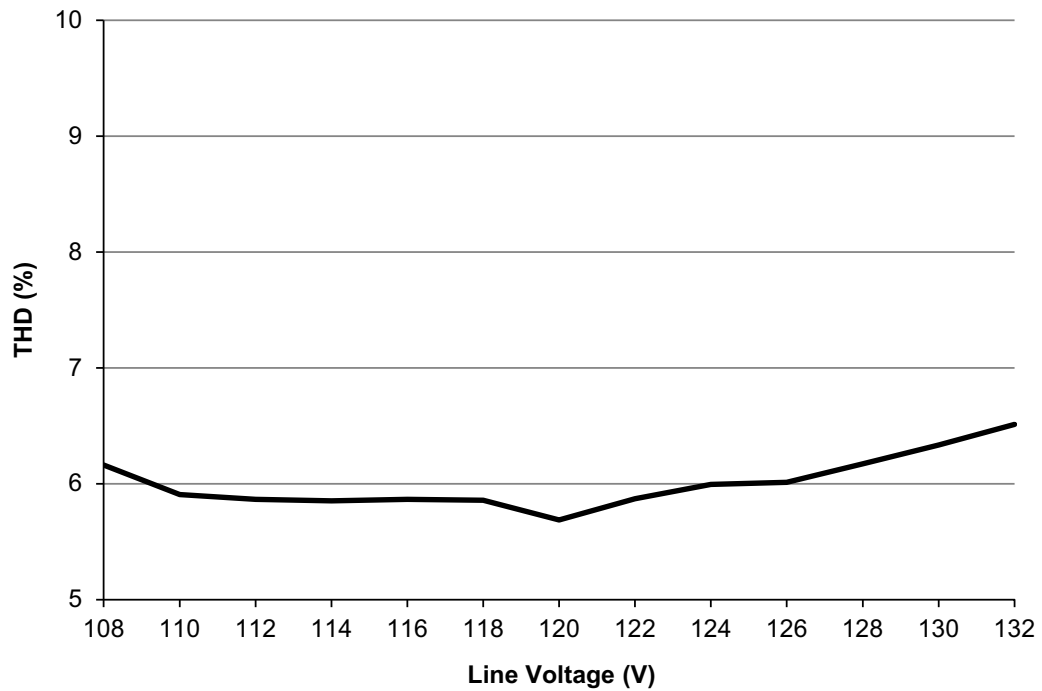

Figure 14. THD vs Line Voltage

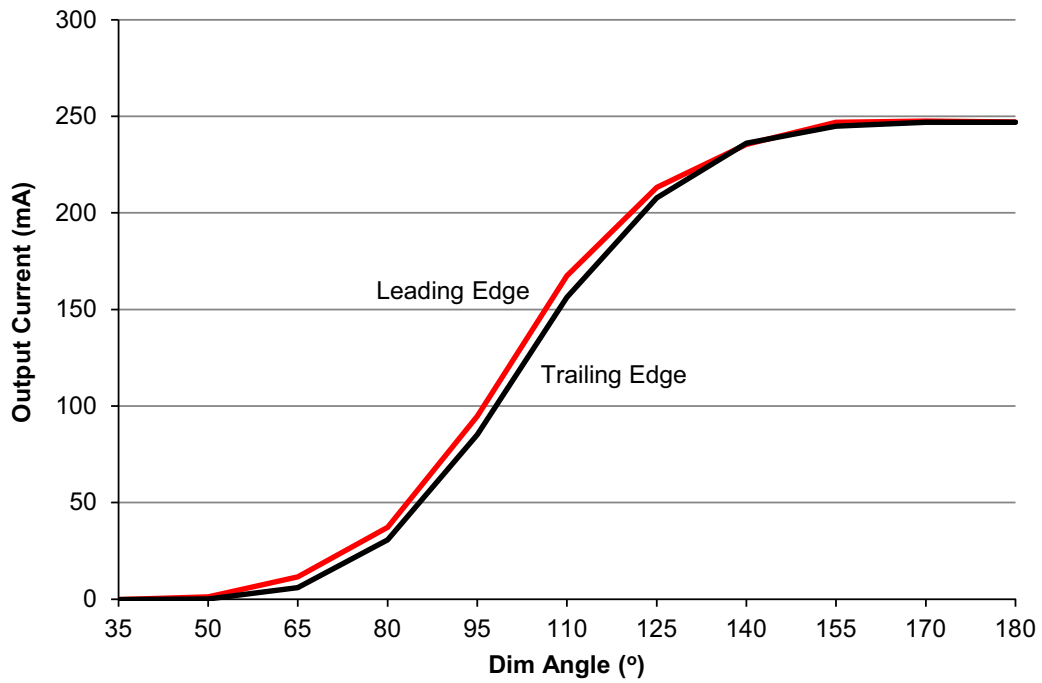

Figure 15. Typical Output Current vs Dim Angle

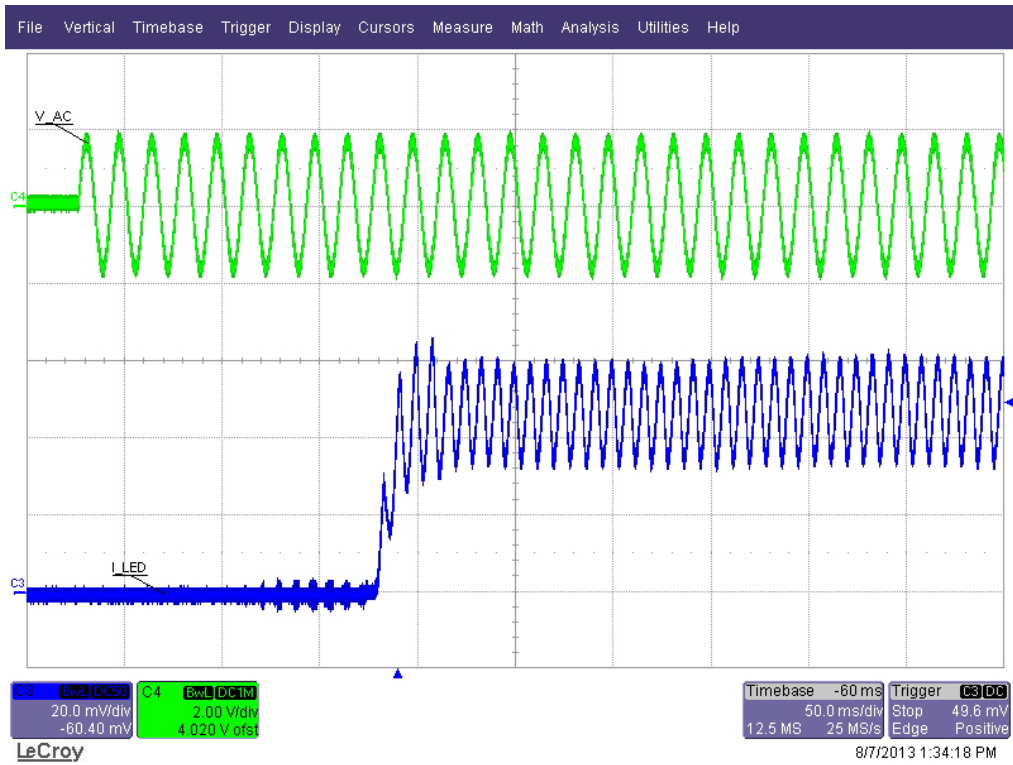

Figure 16. No-dimmer Mode, Startup, 120 VAC

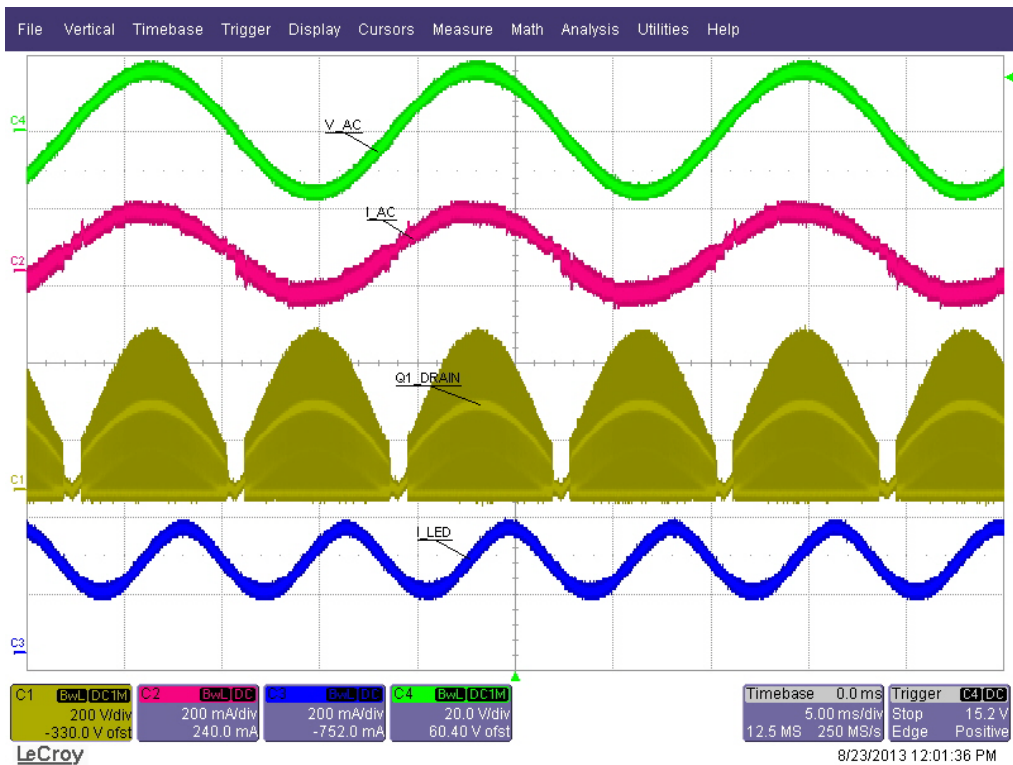

Figure 17. No-dimmer Mode, Steady-state, 120VAC

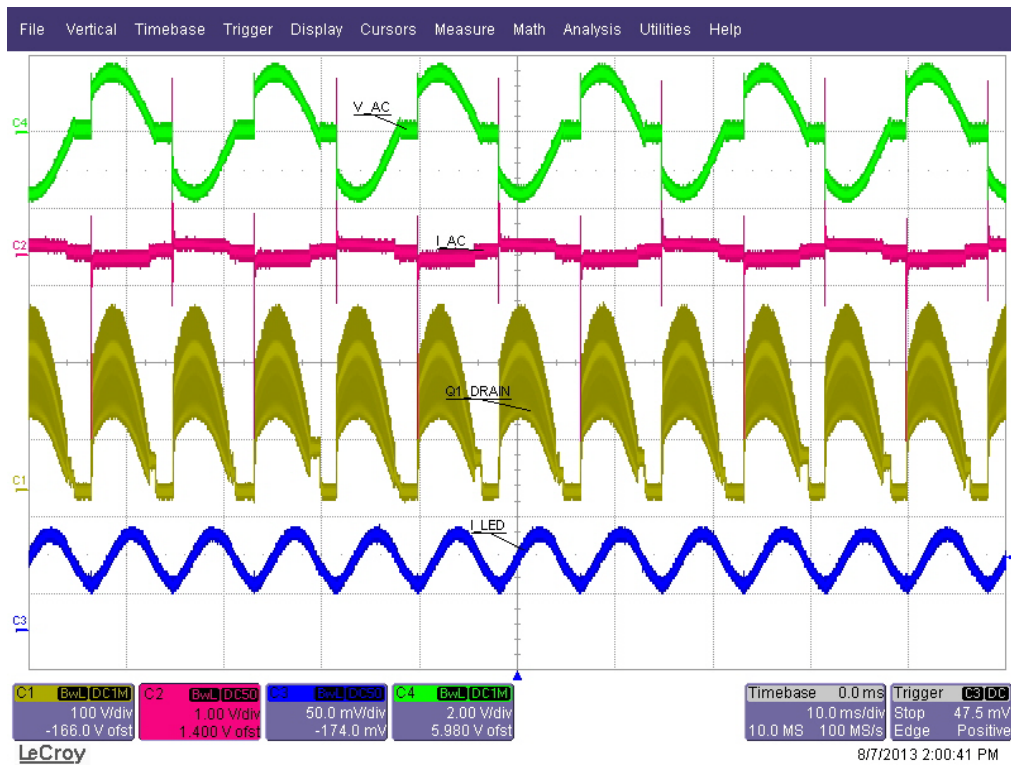

Figure 18. Leading-edge Dimmer Mode, Steady-state, 120VAC

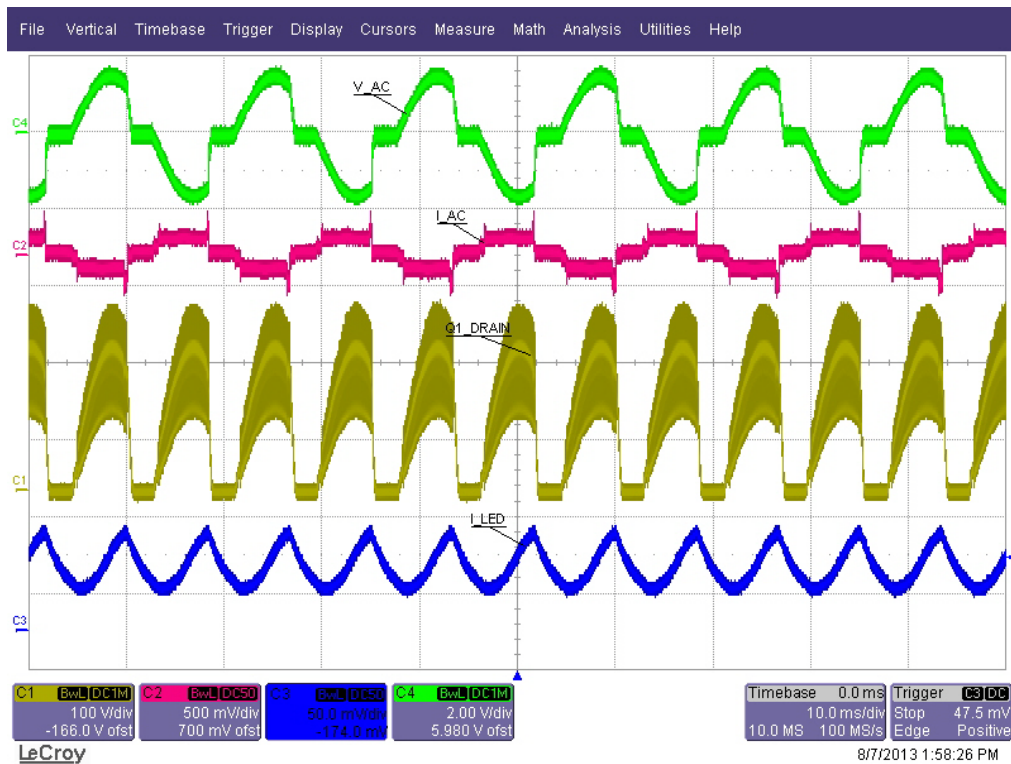

Figure 19. Trailing-edge Dimmer Mode, Steady-state, 120VAC

9. CONDUCTED EMI
Device Under Test: CRD1615A-8W-Z

Operating Conditions: NOMINAL

Test Specification: EN55022:2010

Operator Name: CAL

Scan Settings (1 Range)

Frequencies			Receiver Settings			
Start	Stop	Step	Res BW	M-Time	Atten	Preamp
150 kHz	30 MHz	4.5 kHz	9 kHz (6dB)	50 ms	Auto	Off

Final Measurement
Detectors: QP, AV

Peaks: 10

Meas Time: See scan settings

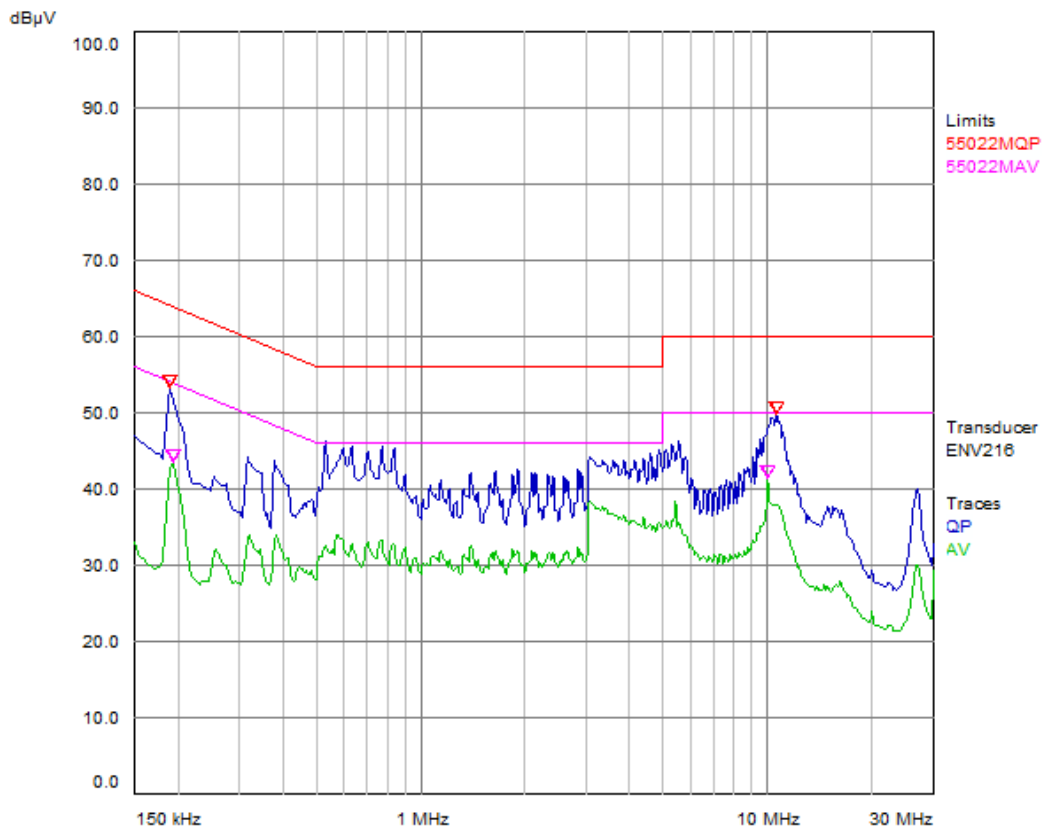
Acc. Margin: 12 dB

Figure 20. Conducted EMI
Final Measurement Results

Trace	Frequency (MHz)	Level (dBµV)	Limit (dBµV)	Delta Limit (dB)	Delta Ref (dB)	Comment
1QP	0.19	53.18	64.01	-10.83		N/on
2AV	10.0005	41.29	50.00	-8.71		N/on

*** = Limit Exceeded**

10. REVISION HISTORY

Revision	Date	Changes
RD1	JUL 2013	Preliminary release
RD2	AUG 2013	Content clarification