

## Automotive dual Transil™ array for ESD protection

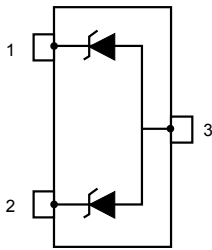
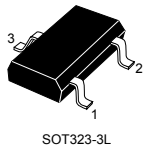

Product status

ESDA37WY

### Features

- AEC-Q101 qualified
- Dual unidirectional Transil functions
- Low leakage current ( $I_R$  max.  $< 1 \mu A$  at  $V_{RM}$ )
- 300 W peak pulse power (8/20  $\mu s$ )
- High ESD protection level: up to 25 kV
- High integration
- Suitable for high density boards
- Complies with the following standards/
  - ISO 10605: C = 330 pF, R = 330  $\Omega$ : 30 kV (air discharge), 30 kV (contact discharge)
  - ISO 7637-3 fast transient: Pulse a:  $V_S = -150 V$ , Pulse b:  $V_S = +100 V$
  - ISO 7637-3 slow transient: Positive pulse:  $V_S = +85 V$ , Negative pulse:  $V_S = -85 V$

### Applications

Where transient overvoltage protection in ESD sensitive equipment is required, such as:

- Entertainment
- Signal communications
- Connectivity
- Comfort and convenience

### Description

This device is a diode array designed to protect 1 line or 2 lines against ESD transients.

The device is ideal for applications where both reduced line capacitance and board space saving are required

It can also be used as bidirectional suppressor by connecting only pin 1 and 2.

# 1 ESDA37WY\_Characteristics

**Table 1. Absolute maximum ratings ( $T_{amb} = 25\text{ °C}$ )**

Symbol	Parameter	Value	Unit	
$V_{pp}$	Peak pulse voltage <sup>(1)</sup>	ISO 10605 (C = 330 pF, R = 330 $\Omega$ ):	kV	
		Contact discharge		30
		Air discharge		30
		ISO 10605 (C = 150 pF, R = 330 $\Omega$ ):		30
		Contact discharge		30
Air discharge	30			
$P_{pp}$	Peak pulse power (8/20 $\mu$ s)	300	W	
$I_{pp}$	Peak pulse current (8/20 $\mu$ s)	6.3	A	
$T_j$	Maximum operating junction temperature range	-55 to 175	$^{\circ}\text{C}$	
$T_{stg}$	Storage junction temperature range	-65 to 175	$^{\circ}\text{C}$	
$T_L$	Maximum temperature for soldering during 10 s	260	$^{\circ}\text{C}$	

1. For a surge greater than the maximum values, the diode will fail in short-circuit.

**Figure 1. Electrical characteristics (definitions)**

Symbol	Parameter
$V_{BR}$	= Breakdown voltage
$V_{CL}$	= Clamping voltage
$V_{RM}$	= Stand-off voltage
$I_{RM}$	= Leakage current
$I_F$	= Forward current
$I_{PP}$	= Peak pulse current
$I_R$	= Breakdown current
$V_F$	= Forward voltage drop
C	= Capacitance
$R_d$	= Dynamic impedance
$\alpha T$	= Voltage temperature

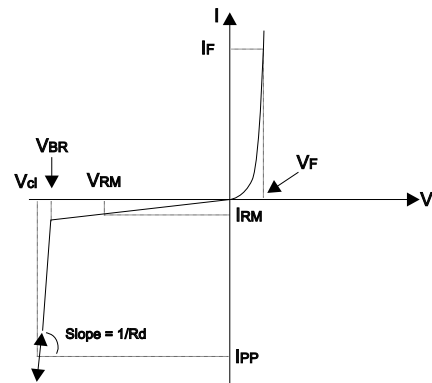

**Table 2. Electrical characteristics ( $T_{amb} = 25\text{ °C}$ )**

Order code	$V_{BR}$ at $I_R$		$I_{RM}$ at $V_{RM}$		$R_d$ <sup>(1)</sup>	$\alpha T$ <sup>(2)</sup>	$C_{jine}$	$V_F$ at $I_F$		
	Min.	Max.	Max.		Typ.	Max.	Typ. at 0 V bias	Max.		
	V	V	mA	$\mu$ A	V	$m\Omega$	$10^{-4}/^{\circ}\text{C}$	pF	V	mA
ESDA37WY	37	43.3	1	1	36	2400	11	48	0.9	10

1. Square pulse  $I_{pp} = 15\text{ A}$ ,  $t_p = 2.5\ \mu\text{s}$

2.  $\Delta V_{BR} = \alpha T \times (T_{amb} - 25\text{ °C}) \times V_{BR}(25\text{ °C})$

## 1.1 Characteristics (curves)

**Figure 2. Peak pulse power dissipation versus initial junction temperature**

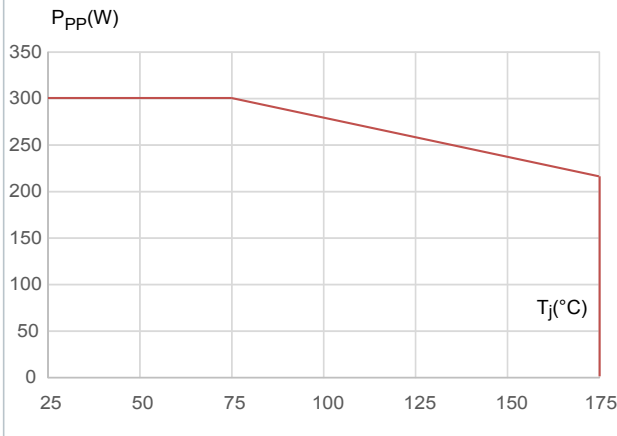

**Figure 3. Peak pulse power versus exponential pulse duration (maximum values)**

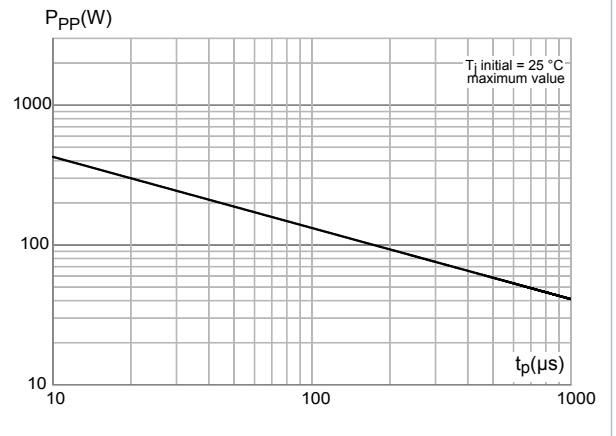

**Figure 4. Variation of clamping voltage versus peak pulse current (maximum values)**

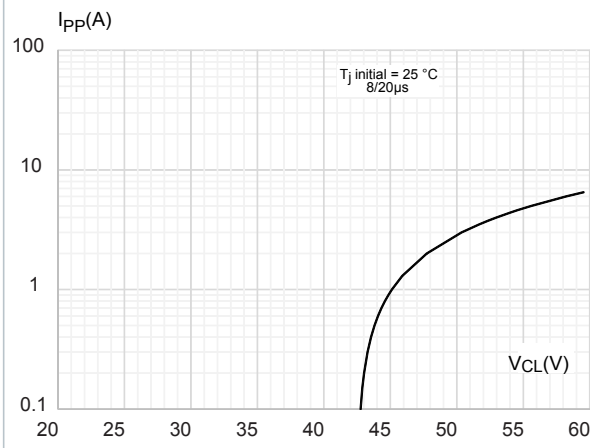

**Figure 5. Variation of leakage current at  $V_R = V_{RM}$  versus junction temperature**

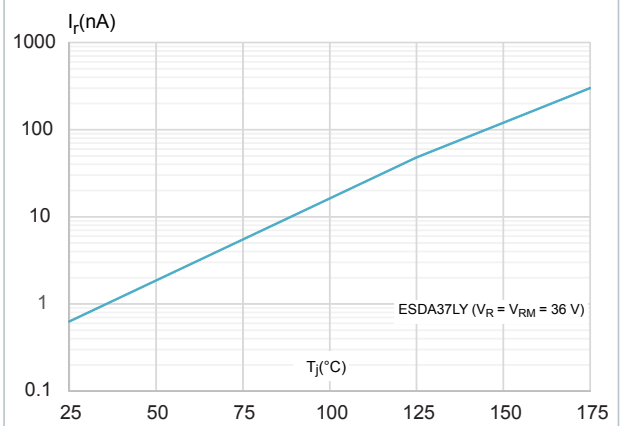

**Figure 6. ISO 7637-3 fast transient pulse a response (VS = -150 V)**

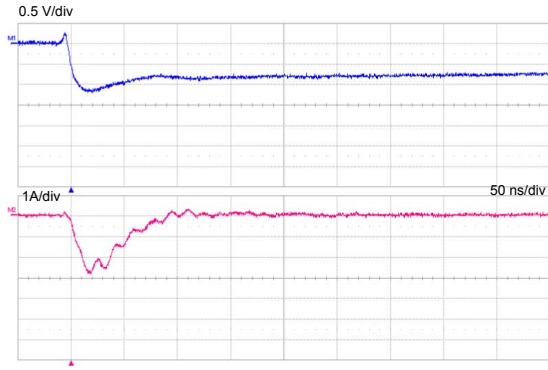

**Figure 7. ISO 7637-3 fast transient pulse b response (VS = +100 V)**

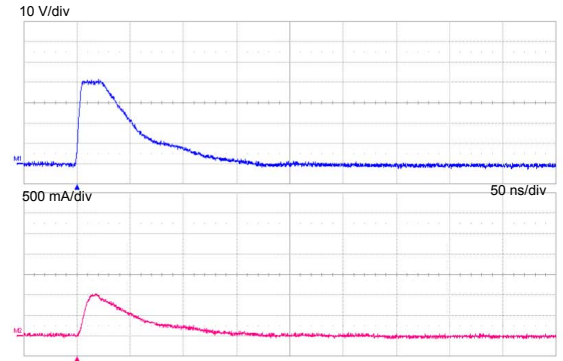

**Figure 8. ISO 7637-3 slow transient positive pulse (VS = +85 V)**

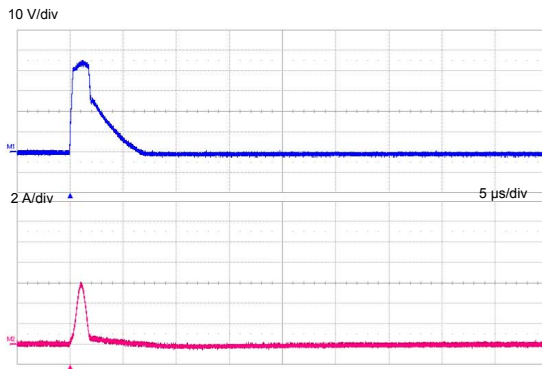

**Figure 9. ISO 7637-3 slow transient negative pulse (VS = -85 V)**

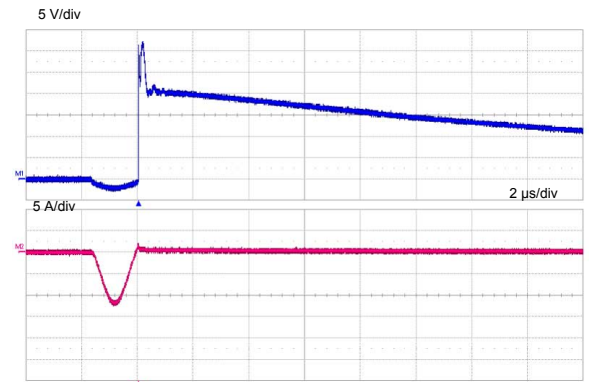

## **2 Application and design guidelines**

---

Refer to STMicroelectronics application note:

- AN2689: Protection of automotive electronics from electrical hazards, guidelines for design and component selection.

### 3 Package information

In order to meet environmental requirements, ST offers these devices in different grades of ECOPACK® packages, depending on their level of environmental compliance. ECOPACK® specifications, grade definitions and product status are available at: [www.st.com](http://www.st.com). ECOPACK® is an ST trademark.

#### 3.1 [Package name] package information

- Epoxy meets UL 94, V0
- Lead-free package

Figure 10. SOT-323 3L package outline

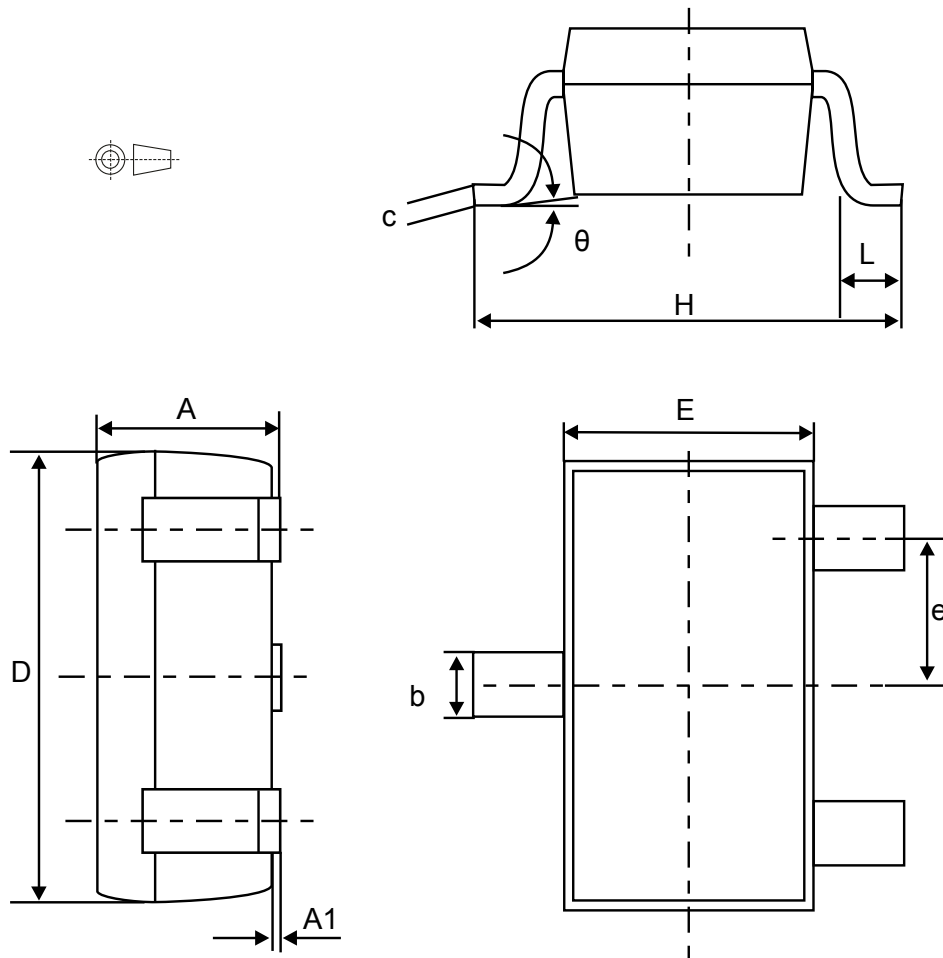
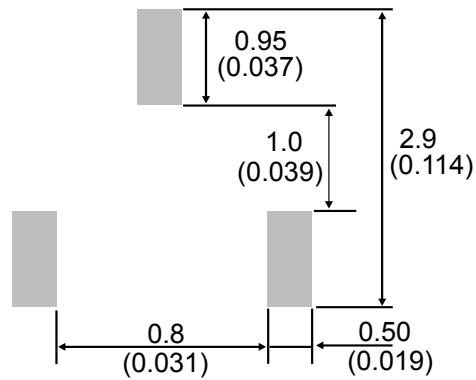

Table 3. SOT323-3L package mechanical data

Ref.	Dimensions					
	Millimeters			Inches		
	Min.	Typ.	Max.	Min.	Typ.	Max.
A	0.8		1.1	0.031		0.043
A1	0.0		0.1	0.000		0.003
b	0.25		0.4	0.0098		0.0157
c	0.1		0.26	0.003		0.0102
D	1.8	2.0	2.2	0.070	0.078	0.086
E	1.15	1.25	1.35	0.0452	0.0492	0.0531
e	0.60	0.65	0.70	0.024	0.026	0.028
H	1.8	2.1	2.4	0.070	0.082	0.094
L	0.1	0.2	0.30	0.004	0.008	0.012
θ		0	30°	0		30°

Figure 11. SOT323-3L recommended footprint



## 4 Recommendation on PCB assembly

### 4.1 Solder paste

1. Halide-free flux qualification ROL0 according to ANSI/J-STD-004.
2. "No clean" solder paste is recommended.
3. Offers a high tack force to resist component movement during high speed.
4. Use solder paste with fine particles: powder particle size 20-45  $\mu\text{m}$ .

### 4.2 Placement

1. Manual positioning is not recommended.
2. It is recommended to use the lead recognition capabilities of the placement system, not the outline centering
3. Standard tolerance of  $\pm 0.05$  mm is recommended.
4. 3.5 N placement force is recommended. Too much placement force can lead to squeezed out solder paste and cause solder joints to short. Too low placement force can lead to insufficient contact between package and solder paste that could cause open solder joints or badly centered packages.
5. To improve the package placement accuracy, a bottom side optical control should be performed with a high resolution tool.
6. For assembly, a perfect supporting of the PCB (all the more on flexible PCB) is recommended during solder paste printing, pick and place and reflow soldering by using optimized tools.

### 4.3 PCB design preference

1. To control the solder paste amount, the closed via is recommended instead of open vias.
2. The position of tracks and open vias in the solder area should be well balanced. A symmetrical layout is recommended, to avoid any tilt phenomena caused by asymmetrical solder paste due to solder flow away.



#### 4.4 Reflow profile

Figure 12. ST ECOPACK® recommended soldering reflow profile for PCB mounting

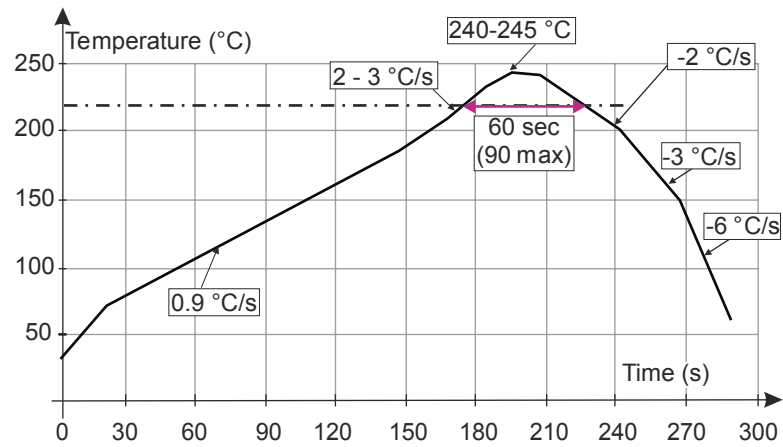

Note: Minimize air convection currents in the reflow oven to avoid component movement.

## 5 ESDA37WY\_Ordering information

Figure 13. Ordering information scheme

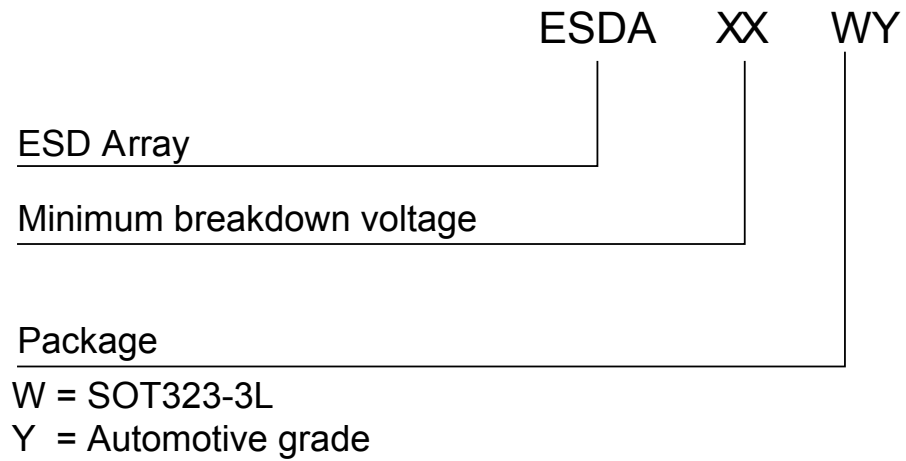

Table 4. Ordering information

Order code	Marking <sup>(1)</sup>	Package	Weight	Base qty.	Delivery mode
ESDA37WY	E3Y	SOT323-3L	6.6 mg	3000	Tape and reel

1. The marking can be rotated by multiples of 90° to differentiate assembly location.

## Revision history

**Table 5. Document revision history**

Date	Revision	Changes
18-Dec-2017	1	First issue.
09-Apr-2018	2	Updated <a href="#">Figure 2. Peak pulse power dissipation versus initial junction temperature.</a>

**IMPORTANT NOTICE – PLEASE READ CAREFULLY**

STMicroelectronics NV and its subsidiaries (“ST”) reserve the right to make changes, corrections, enhancements, modifications, and improvements to ST products and/or to this document at any time without notice. Purchasers should obtain the latest relevant information on ST products before placing orders. ST products are sold pursuant to ST’s terms and conditions of sale in place at the time of order acknowledgement.

Purchasers are solely responsible for the choice, selection, and use of ST products and ST assumes no liability for application assistance or the design of Purchasers’ products.

No license, express or implied, to any intellectual property right is granted by ST herein.

Resale of ST products with provisions different from the information set forth herein shall void any warranty granted by ST for such product.

ST and the ST logo are trademarks of ST. All other product or service names are the property of their respective owners.

Information in this document supersedes and replaces information previously supplied in any prior versions of this document.

© 2018 STMicroelectronics – All rights reserved