

WIZ108SR User Manual

Version 1.42

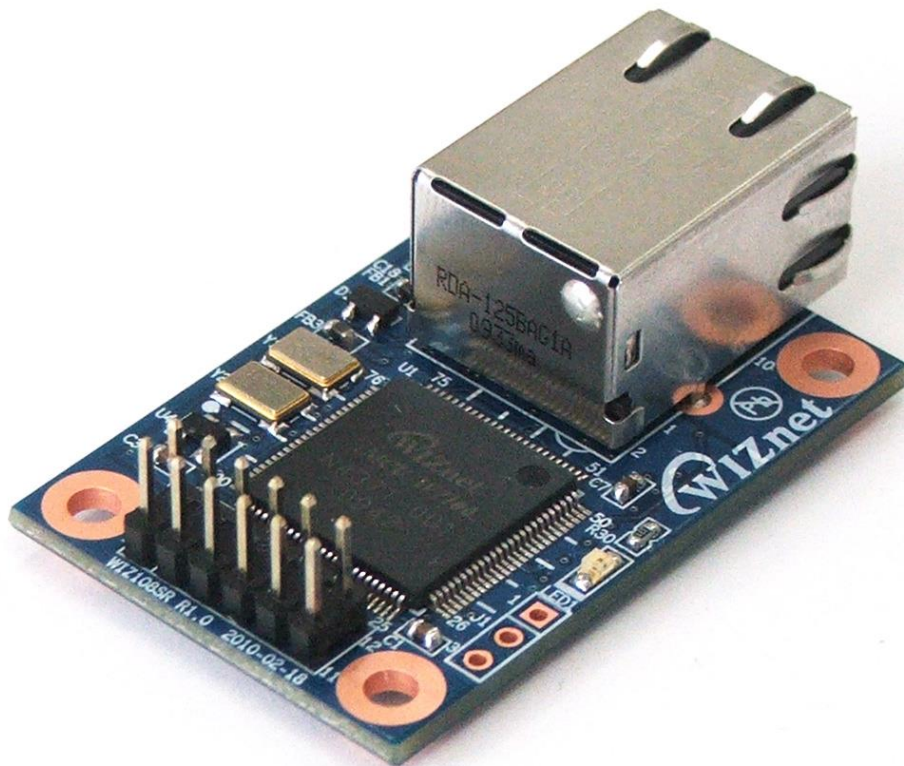

Document Revision History

Date	Revision	Changes
2010-04-23	V1.00	Official Release
2010-04-28	V1.10	Modify the serial command list
2012-11-07	V1.20	Added explanation about WIZ108SR revision <ol style="list-style-type: none"> 1. Added Module Revision Notification. 2. Modified "1. Introduction". 3. Modified "1.2 Product Contents". 4. Modified "1.3 Product Specification". 5. Added "Table 4 Available firmware version with hardware version".
2013-02-05	V1.30	Added "4.4 Booting Time" and "4.5 HW_TRIG Pin". Added attention for using serial command. < Page 25 >
2015-03-25	V1.40	Added explanation about <u>WIZ108SR-EVB revision 1.4</u> <ol style="list-style-type: none"> 1. Added EVB Revision Notification 2. Added "4.4 Booting Time" and "4.5 HW_TRIG Pin". 3. Added "Table 4. Available firmware version with hardware version". Added descriptions for <u>firmware 4.04 or above</u> <ol style="list-style-type: none"> 1. Added description for H/W Factory reset function removal and No-PHY link detection function using HW_TRIG pin. Modified the Table 5. Serial command response list <ol style="list-style-type: none"> 1. Added the additional return value (3:ATMODE) of Device status (ST) command.
2015-04-15	V1.41	Fixed the Typo in "3.2 Serial Command List" <ol style="list-style-type: none"> 1. Modified the Time unit for Inactivity timer(ms-><u>sec</u>)
2017-06-19	V1.42	Fixed command parameter in "Table 1. Serial command list" <ol style="list-style-type: none"> 1. Delete "2: 9bit" parameter in DB.

Module Revision Notification

<WIZ108SR V1.2 / V1.4 Module>

WIZnet mainly revised the hardware and software of WIZ108SR with the discontinuance of the main MCU, W7100, in November 2012.

We replaced the W7100 with W7100A, and upgraded several functions for better performance and convenience. The change detail is as following.

Part #	Hardware Revision	Description of Changes						
WIZ108SR	V1.2	1. Operation Temperature : Supports industrial temperature range <table border="1" data-bbox="651 719 1254 819"> <tr> <td>Hardware Version</td> <td>V1.1 or below</td> <td>V1.2</td> </tr> <tr> <td>Temp. Range</td> <td>0℃ -70℃</td> <td>-40℃ - 85℃</td> </tr> </table> 2. Reinforce ESD protection by adding TVS arrays on the RJ45 side. 3. Change main MCU from W7100 to W7100A with the discontinuance of W7100. 4. Serial signals support 3.3V TTL level. (Optional)	Hardware Version	V1.1 or below	V1.2	Temp. Range	0℃ -70℃	-40℃ - 85℃
	Hardware Version	V1.1 or below	V1.2					
	Temp. Range	0℃ -70℃	-40℃ - 85℃					
V1.3	This revision module was not released.							
V1.4	1. Operation Temperature : Supports industrial temperature range <table border="1" data-bbox="651 1133 1094 1234"> <tr> <td>Hardware Version</td> <td>V1.4 or above</td> </tr> <tr> <td>Temp. Range</td> <td>-40℃ - 85℃</td> </tr> </table> 2. Removed the MIC811RU for MCU hardware reset. 3. Added the TPS3823-33 as external watchdog for MCU.	Hardware Version	V1.4 or above	Temp. Range	-40℃ - 85℃			
Hardware Version	V1.4 or above							
Temp. Range	-40℃ - 85℃							

Since the hardware form factors and pin maps of all revisions are compatible, ones can replace the old one with the new one without changing their existing hardware design. However, they have to use the appropriate firmware according to hardware version. **If they upload the wrong firmware, the module may be not work properly.**

Part #	Hardware Version	Available Firmware Version	Remark
WIZ108SR	V1.1 or below	V2.20 (the latest one)	If you upload the wrong firmware, the module may not work properly. There is no difference in all functions and features
	V1.2	V3.04 - V3.14	
	V1.4 or above	V4.04 or above	



WIZnet's Online Technical Support

If you have something to ask about WIZnet products, write down your question on Q&A Board in WIZWiki Forum (<http://wizwiki.net/forum/>). WIZnet will give an answer as soon as possible.

COPYRIGHT NOTICE

Copyright 2015 WIZnet Co., Ltd. All Rights Reserved.

Technical Support: Our Forum, <http://wizwiki.net/forum/>

Sales & Distribution: sales@wiznet.co.kr

For more information, visit our website at <http://www.wiznet.co.kr>

Table of Contents

1. Introduction	1
1.1 Key Features.....	1
1.2 Product Contents (WIZ108SR-EVB model)	2
1.3 Product Specification	3
1.3.1 WIZ108SR Module Specification	3
1.3.2 WIZ108SR Module Interface.....	4
1.3.3 Pin Header Connector Pin-Assignment	5
2. Getting Started	6
2.1 Configuration Tool	6
2.1.1 Network Configuration	6
2.1.2 Serial Configuration	11
2.1.3 Option Configuration.....	13
2.2 Firmware Upload	15
3. Serial Configuration	18
3.1 Serial Command Format.....	18
3.2 Serial Command List	18
3.3 Serial Command Executing Example	24
4. Hardware Specification.....	26
4.1 WIZ108SR Dimension	26
4.2 WIZ108SR Signal Connection Method.....	27
4.2.1 RS-422 Interface Connection	27
4.2.2 RS-485 Interface Connection	27
4.3 WIZ108SR Interface Board Schematic.....	28
4.4 Booting Time	29
4.5 HW_TRIG PIN	29
5. Warranty	30

Figures

FIGURE 1. WIZ108SR INTERFACE	4
FIGURE 2. WIZ108SR CONNECTOR PIN ASSIGNMENT	5
FIGURE 3. WIZ108SR CONFIGURATION TOOL (NETWORK CONFIGURATION PAGE)	6
FIGURE 4. SEARCHING WITH UDP BROADCAST METHOD	7
FIGURE 5. SEARCHING WITH TCP UNICAST METHOD	7
FIGURE 6. SIMPLE PING TEST PROGRAM	8
FIGURE 7. WIZ108SR CONFIGURATION TOOL (SERIAL CONFIGURATION PAGE)	11
FIGURE 8. WIZ108SR CONFIGURATION TOOL (OPTION CONFIGURATION PAGE)	13
FIGURE 9. FILE OPEN DIALOG BOX FOR FIRMWARE UPLOADING	15
FIGURE 10. FIRMWARE UPLOADED SUCCESSFULLY	16
FIGURE 11. ERROR MESSAGE ABOUT UPLOADING DIFFERENT VERSION FIRMWARE	17
FIGURE 12. SERIAL COMMAND FORMAT	18
FIGURE 13. SERIAL COMMAND EXECUTING EXAMPLE	25
FIGURE 14. WIZ108SR DIMENSIONS (UNIT : MM)	26
FIGURE 15. RS-422 INTERFACE CONNECTION METHOD	27
FIGURE 16. RS-485 INTERFACE CONNECTION METHOD	27
FIGURE 17. WIZ108SR INTERFACE BOARD SCHEMATIC	28
FIGURE 18 WIZ108SR'S OPERATION FLOW	29

Tables

TABLE 1. PRODUCT CONTENTS	2
TABLE 2. WIZ108SR MODULE SPECIFICATION	3
TABLE 3. PIN HEADER CONNECTOR PIN-ASSIGNMENT DESCRIPTION	5
TABLE 4. AVAILABLE FIRMWARE VERSION WITH HARDWARE VERSION	17
TABLE 5. SERIAL COMMAND LIST	19
TABLE 6. WIZ108SR'S BOOTING TIME	29

1. Introduction

WIZ108SR is a gateway module that converts RS-422/485 protocol into TCP/IP protocol. It enables remote management and control of a device through the TCP/IP network by connecting to the existing equipment with RS-422/485 serial interface. In other words, WIZ108SR is a protocol converter that transmits the data sent by serial equipment as TCP/IP data type and converts back the TCP/IP data received through the network into serial data to transmit back to the equipment.

1.1 Key Features

- Compact Sized RS422/485 to Ethernet
- Provides Quick and Simple Internet Connection to Serial Devices
- Supports Firmware Customization according to Customer's Requirement
- Guarantees Stable and Reliable Data Communication by using W7100A One chip solution
- Provides User-Friendly Configuration Tool Program
- User Password Configurable for Security
- Supports Serial Command for Serial configuration
- 10/100 Mbps Ethernet & Max 230Kbp Serial Interface
- Supports IP Configuration - Static, DHCP
- Supports DNS
- Compact Size : 48mm X 30mm X 18mm (L x W x H)
- RoHS Compliant

1.2 Product Contents (WIZ108SR-EVB model)





WIZ108SR EVB		WIZ108SR
		WIZ108SR Interface Board
Accessories		12-pin Cable (Connect WIZ108SR with Interface Board)
		LAN Cable

Table 2. Product Contents

 If there is any missing item, contact to the shop where you purchased.

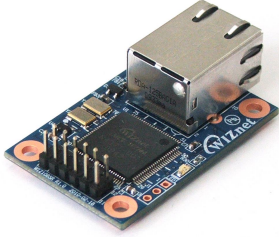
1.3 Product Specification

1.3.1 WIZ108SR Module Specification

WIZ108SR includes WIZnet's hardwired TCP/IP chip that embedded the most of TCP/IP protocols such as TCP, UDP, IP, ARP, ICMP, IGMP and Ethernet MAC. 10Mbps and 100Mbps Ethernet are all supported and one standard Ethernet Jack is mounted in the board of WIZ108SR.

One serial port is provided in WIZ108SR via 12-pin connector which features the standard RS-422/485 specification. WIZ108SR can be powered by a DC 3.3V power supply with the 250mA current supply. The detailed specifications are listed in Table 2

Architecture	TCP / IP	W7100A
	PHY	Included in W7100A Auto negotiation (Full-duplex and Half-duplex) Auto MDI/MDIX
	Serial	RS-422 / RS-485
	MCU	Included in W7100A (Fully software compatible with industrial standard 8051) Internal 2KBytes Boot ROM Internal 64KBytes embedded program FLASH memory Internal 256Bytes embedded data FLASH memory Internal 64KBytes embedded SRAM Internal 32KBytes memory for TCP/IP data communication
Serial	Interface	Included RS-422 / 485 Transceiver,
	Signals	RS-422 : TXD+, TXD-, RXD+, RXD- RS-485 : TRXD+, TRXD-
	Parameters	RS-422 / RS-485 Interface select RS-485 Direction control
	Speed	Up to 230Kbps
Dimensions	48mm x 30mm x 18mm (Include connector size)	
Connector type	2.54mm Pitch Pin-header, 12Pin (2*6)	
Input voltage	DC 3.3V	
Max power consumption	250mA	
Temperature	-40°C ~ 85°C (Operation), -40°C ~ 85°C (Storage)	
Humidity	10 ~ 90%	

Table 3. WIZ108SR Module Specification

1.3.2 WIZ108SR Module Interface

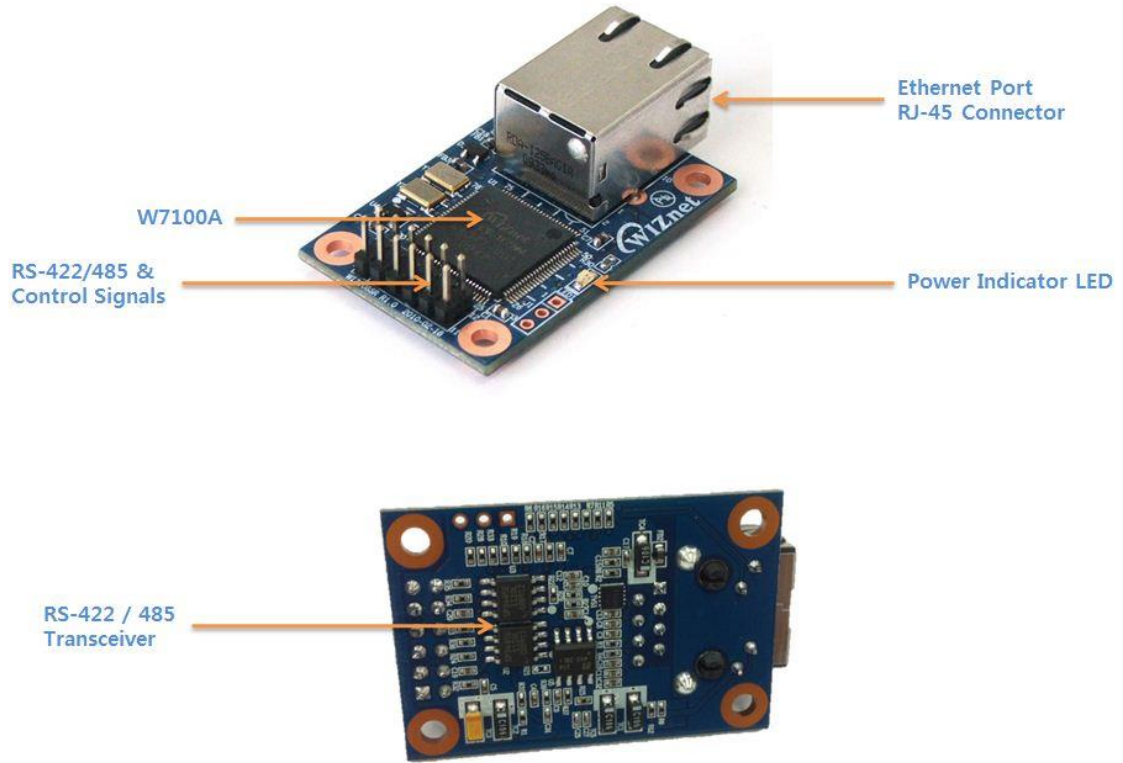

Figure 1. WIZ108SR Interface

1.3.3 Pin Header Connector Pin-Assignment

WIZ108SR provides an external connector to connect it with your application board. The pin assignment and definition of the connector are introduced in Figure 2 and the specification of each pin is described in Table 3.

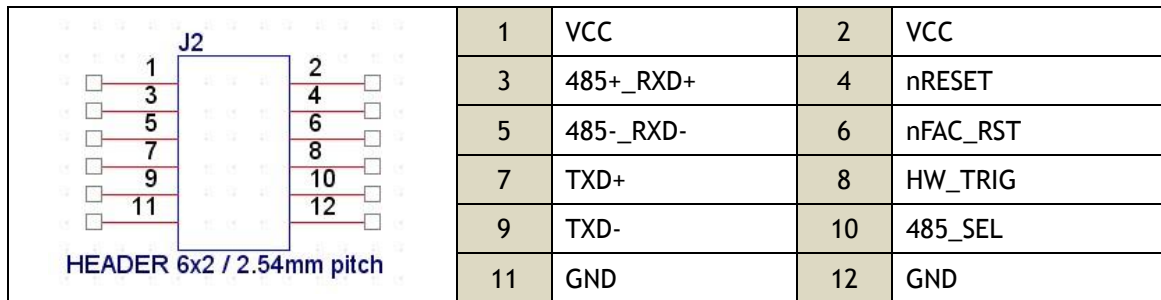

Figure 2. WIZ108SR Connector Pin Assignment

Pin Number	Signal	Description
1	VCC	System Power input (3.3V)
2	VCC	System Power input (3.3V)
3	485+_RXD+	RS-485 : TRXD+ RS-422 : RXD+
4	nRESET	System Reset signal input / Active Low
5	485-_RXD-	RS-485 : TRXD- RS-422 : RXD-
6	nFAC_RST	Factory Reset signal input / Active Low [Function Removed: Firmware v4.04 or above] The H/W Factory reset function pin removed for more stable operation. but S/W Factory reset still exists.
7	TXD+	RS-422 : TXD+
8	HW_TRIG	Hardware Trigger signal input / Low : CMD mode [In the initial time, this pin is INPUT for Hardware Trigger(for serial command mode). After that, this pin is OUTPUT for connection status. When the connection is established, this pin goes Low. And, it will go HIGH when connection is closed.] [Function Added: Firmware v4.04 or above] In No-PHY link (like Ethernet cable is disconnected) case, HW_TRIG pin generates High and low signal in turns every second. When returning to normal condition, HW_TRIG displays TCP connection status as usual.
9	TXD-	RS-422 : TXD-
10	485_SEL	[RS-422 / 485 Select] Pulled Low : RS-422 / Floating : RS-485
11	GND	System Ground
12	GND	System Ground

Table 4. Pin Header Connector PIN-Assignment Description

2. Getting Started

2.1 Configuration Tool

2.1.1 Network Configuration

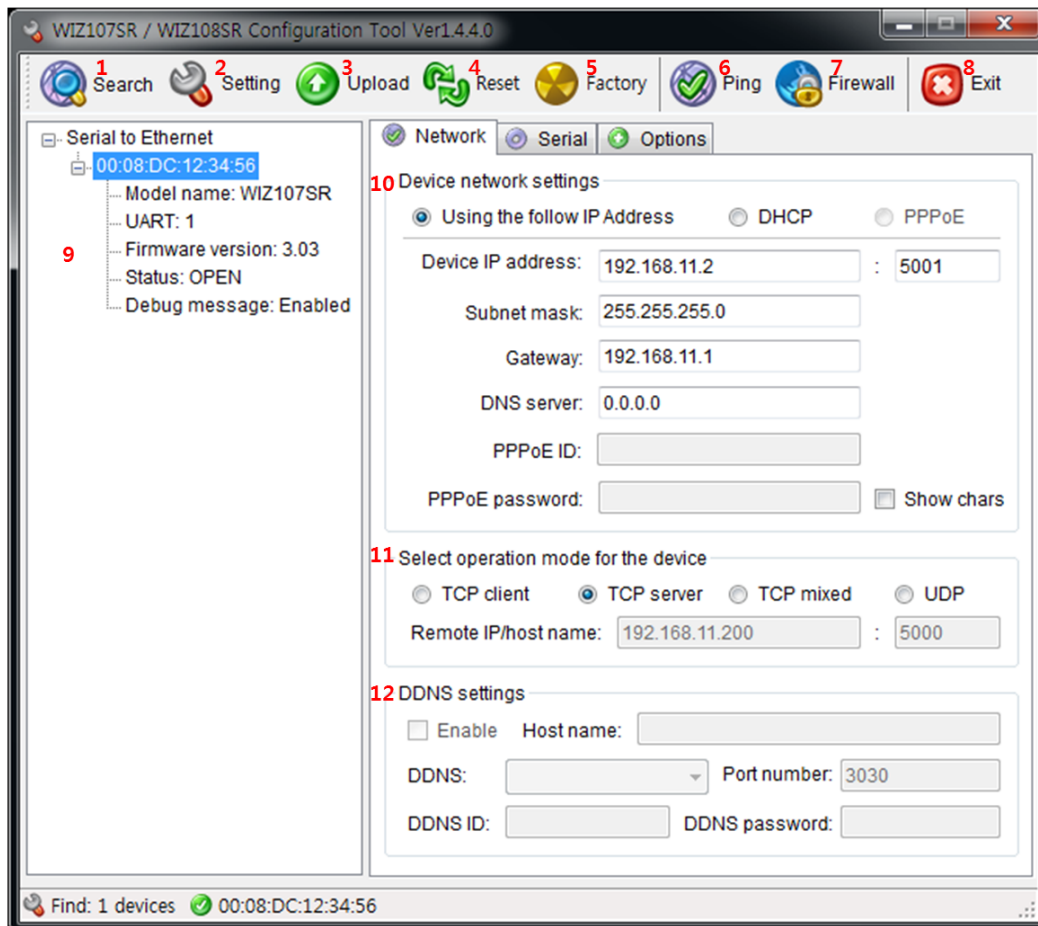

Figure 3. WIZ108SR Configuration Tool (Network Configuration Page)

1) Search

The Search function is used to search all devices existing in the same LAN or in WAN. By using UDP broadcast as shown in Figure 4, all connected devices in the same subnet will be found. If the TCP unicast method is checked, the specified IP address must be given as shown in Figure 5. The founded device will be listed in the “Serial to Ethernet” tree with its MAC address.

Please, note the identification code must be input if the device has been configured with one identification code.

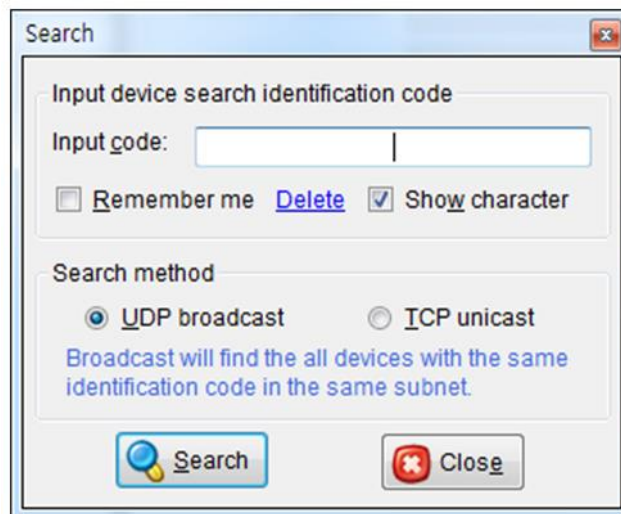

Figure 4. Searching with UDP broadcast method

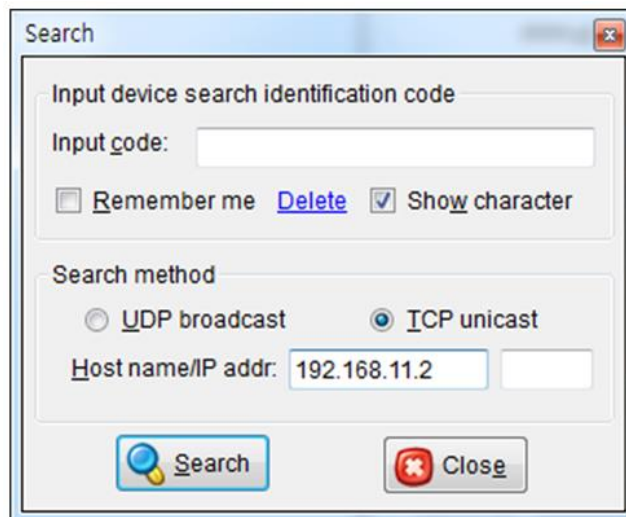

Figure 5. Searching with TCP unicast method

2) Setting

This function is to complete the configuration change.

If you select the MAC Address from the “Serial to Ethernet” tree, the default configuration value of the module will be displayed. Change the configuration and click “Setting” button to complete the configuration. The module will re-initialize with the changed configuration. Changed value is saved in the EEPROM of the module. Thus, the value is not removed even though power is disconnected.

3) Upload

Firmware will be uploaded through network

4) Reset

Reset and restart the selected module if you select the MAC Address from the tree and click “Reset” button.

5) Factory

All value is initialized to Factory default value if you select the MAC Address from the tree and click “Factory” button.

6) Ping

Pop up the Simple Ping application program, you can test the ping operation.



Figure 6. Simple Ping Test Program

7) Firewall

Pop up the Windows Firewall setup program.

8) Exit

Close the configuration Tool Program.

9) Search window

If you click “Search” button, all the MAC address on a same subnet, will be displayed this area. You can see the basic information such as Model name, Firmware version Etc.

10) Network Setting Method

Select IP setting mode, you can select one of Static, DHCP.

(PPPoE mode is not supported in the WIZ108SR)

- Using the follow IP Address (Static)

This is option for setting WIZ108SR module’s IP with static IP address. Firstly, select MAC address which you wanted to set as static IP in the board list. Then “Device IP, Subnet, Gateway box” will be enabled. Input Static IP address and click “setting” button. Then set the IP address as you want.

- DHCP

Set this option to use DHCP mode. Firstly, check ‘DHCP’ and click ‘Setting’ button. If IP

address is successfully acquired from DHCP server, the MAC address will be displayed on the configuration window. (It takes some time to acquire IP address from DHCP server)

When a module on the board list is selected, IP address, Subnet mask and Gateway are displayed. If module could not acquire network information from DHCP server, IP address, Gateway Address and Subnet mask will be initialized to 0.0.0.0.

11) Network Operation Mode

Client / server / mixed : This is to select the communication method based on TCP. TCP is the protocol to establish the connection before data communication, but UDP just processes the data communication without connection establishment. The Network mode of WIZ108SR can be divided into TCP Server, TCP Client and Mixed mode according to the connection establishing method. At the TCP server mode, WIZ108SR operates as server on the process of connection, and waits for the connection trial from the client. WIZ108SR operates as client at the TCP Client mode on the process of connection, and tries to connect to the server's IP and Port. Mixed modes supports both of Server and Client. The communication process of each mode is as below.

<TCP server mode Communication>

At the TCP Server mode, WIZ108SR waits for the connection requests.

TCP Server mode can be useful when the monitoring center tries to connect to the device (where WIZ108SR is installed) in order to check the status or provide the commands. In normal time WIZ108SR is on the waiting status, and if there is any connection request (SYN) from the monitoring center, the connection is established (ESTABLISH), and data communication is processed (Data Transaction). Finally connection is closed (FIN).

In order to operate this mode, Local IP, Subnet, Gateway Address and Local Port Number should be configured first.

The Data transmission proceeds as follows,

1. The host connects to the WIZ108SR which is configured as TCP Server mode.
2. As the connection is established, data can be transmitted in both directions - from the host to the WIZ108SR, and from the WIZ108SR to the host

<TCP client mode Communication>

If WIZ108SR is set as TCP Client, it tries to establish connection to the server.

To operate this mode, Local IP, Subnet, Gateway Address, Server IP, and Server port

number should be set. If server IP had domain name, use DNS function.

In TCP Client mode, WIZ108SR can actively establish a TCP connection to a host computer when power is supplied.

The Data transmission proceeds as follows:

1. As power is supplied, WIZ108SR board operating as TCP client mode actively establishes a connection to the server.
2. If the connection is complete, data can be transmitted in both directions - from the host to the WIZ108SR and from WIZ108SR to the host

<Mixed mode Communication>

In this mode, WIZ108SR normally operates as TCP Server and waits for the connection request from the peer. However, if WIZ108SR receives data from the serial device before connection is established, it changes to the client mode and sends the data to the server IP. Therefore, at the mixed mode, the server mode is operated prior to the client mode.

As like TCP Server mode, the Mixed mode is useful for the case that the monitoring center tries to connect to the serial device (in which WIZ108SR is used) to check device status. In addition to this, if any emergency occurs in the serial device, the module will change to Client mode to establish the connection to the server and deliver the emergency status of the device.

<Use UDP mode Communication>

UDP is not a connection oriented protocol. But the communication port should also be defined well. If the UDP mode is selected, the data from serial interface can be defined where to delivery via the “Sever IP Address” and “Port”, and the WIZ108SR can also be defined where to receive Ethernet data from via the “Remote Peer IP Address” definition. If the data destination and source are the same, the two IP address will also be the same. Please note the destination and source are using the same port.

12) DDNS Setting

DDNS function is not supported in the WIZ108SR.

2.1.2 Serial Configuration

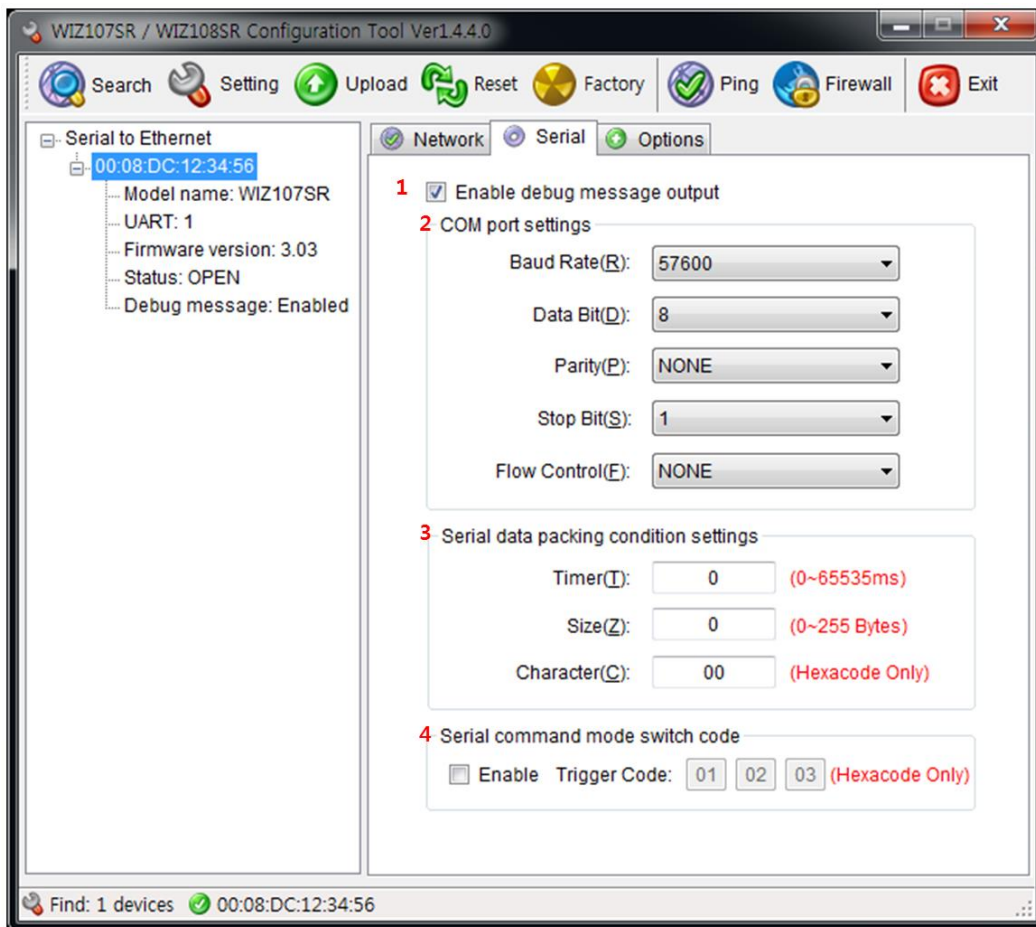

Figure 7. WIZ108SR Configuration Tool (Serial Configuration Page)

1) Enable debug message output

If this mode is checked, you can monitor the status of module and socket message like listen OK, connect fail etc. through serial terminal. If debug mode is on, debug message can cause abnormal operation of the serial device. Therefore, just use this mode only for debug mode.

2) COM port Setting

The parameters of COM port of WIZ108SR are listed well in this page. Users can set the COM port of WIZ108SR by selecting the value of each parameter in the drop down list.

 By clicking the “Setting” button, changed value can be applied.

3) Serial data packing condition settings

You can designate how the serial data can be packed to send to the Ethernet.

In default mode, WIZ108SR checks the serial buffer and sends any received data to Ethernet without any standard. Therefore, the data can be regarded as error data due to

inconsistent data length. In order to solve this problem, the data from serial can be packed according to the specified condition before sending to Ethernet. The condition is as below.

Time: If there is not any new data during designated time, all data in the serial buffer is converted to Ethernet packet. If new data is received, the time is re-calculated and the received data is saved in the serial buffer. Time condition can be utilized when the serial data size is variable and has no ending character, but needs to be delivered in frame unit. (If the value is '0', option is not used)

Size: When data is collected as much as the defined size in the serial buffer, it is transmitted to Ethernet (If the value is '0', option is not used)

Character: The data is collected in the serial buffer until specified character is received, and transmitted to Ethernet. The character can be specified in Hex formation. (The value is '0', this option is not used)

One of three conditions is satisfied, the data is transmitted to the Ethernet.

Ex) Delimiter: Size=10, Char=0x0D

Serial data : 0123456789abc

Ethernet data : 0123456789

☞ "abc" data remains in the serial buffer of module.

4) Serial command mode switch code

This function is for module configuration not through network with Configuration tool but through serial communication. At the default status, the serial command mode is disabled. When you want to set via serial communication, check "enable".

2.1.3 Option Configuration

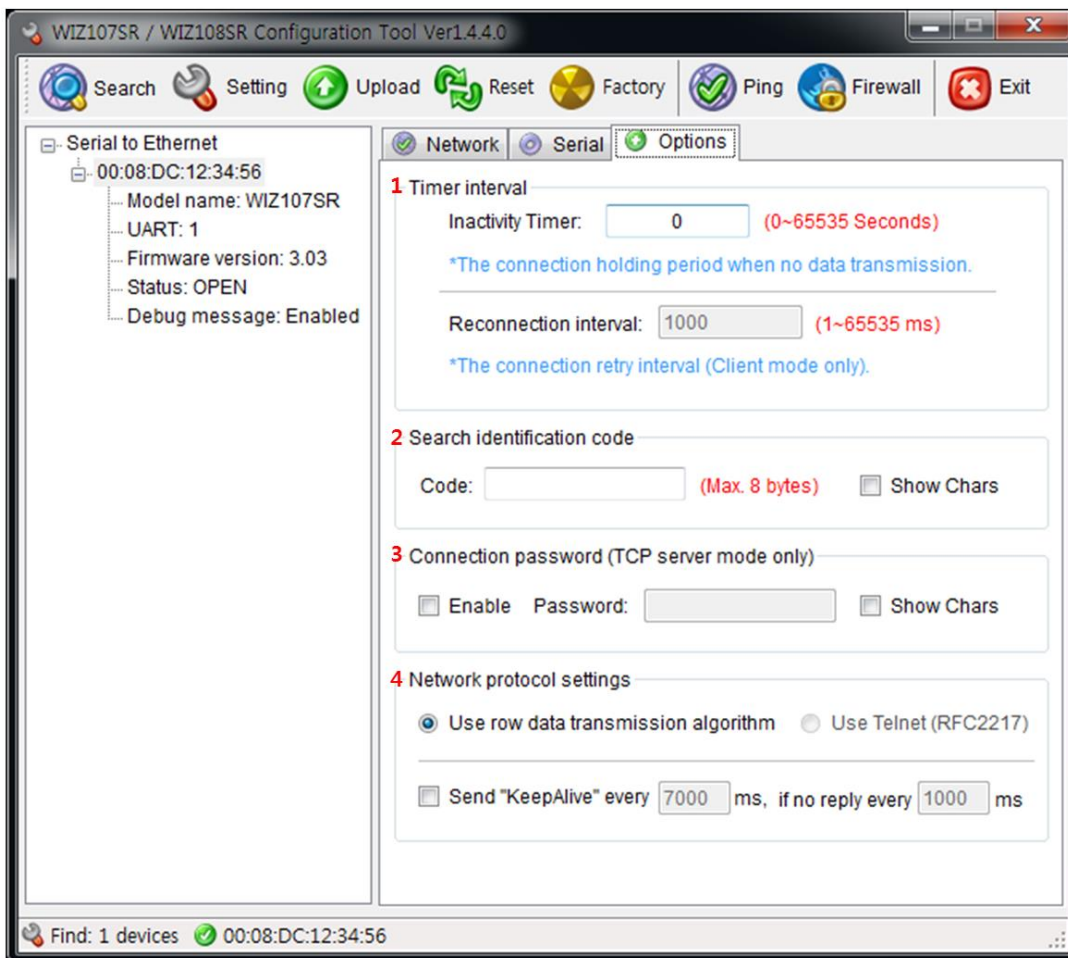

Figure 8. WIZ108SR Configuration Tool (Option Configuration Page)

1) Timer interval

- **Inactivity Timer** : The connection holding period when no data transmission.
- **Reconnection Interval** : The connection retry interval (client mode only)

After the connection is established, if there is not data transmission within the time defined in Inactivity time, the connection is closed automatically. The default value is '0'. If '0' is set, this function is not activated. In this default setting, the connection is maintained even though there is no data transmission. In order to close the connection, the 'Close' command should be given.

This function can be used for more than two or more systems to connect to a WIZ108SR module. If one system holds the connection to the WIZ108SR, other systems cannot connect to the module. If there is no data transmission during the time defined in Inactivity time,

the connection will be closed for other system to be connected.

Inactivity Time also can be useful for the case when the server system is unexpectedly shut down. In this status, if there is not any data communication during the time defined in the Inactivity time, WIZ108SR will close the connection and enter into waiting status.

2) Search identification code

For the security issues, WIZ108SR can have its own password for searching. The password is stored in the EEPROM of WIZ108SR, and it can be modified via this configuration tool. The password can be any alphabet or number. Its length can be variable and its maximum length is 8 bytes. The password is case sensitive.

3) Connection password

This function is available only when WIZ108SR works in server mode. If this function is enabled, the remote client should send the password to WIZ108SR before data transmission. Please, note the password is case sensitive.

4) Network protocol settings

There are two kinds of data transmission protocol: one is raw data transmission, and the other is using Telnet (RFC2217).

But in current version, only the raw data transmission is supported.

If the 'Keep alive' function is enabled, WIZ108SR will send keep alive packet in every user set minutes if no reply received after the user set period.

2.2 Firmware Upload

- 1) Run the Configuration Tool program and click “Search” button, and input search password in the password popup dialog if you set the search password.
- 2) If the module is properly connected to the network then MAC address will be displayed on the “Serial to Ethernet” search result area.
- 3) Select a MAC address shown in search result and click “Upload” button.

☞ Before uploading through Ethernet, you should set the network information of WIZ108SR first by Configuration Tool program.

- 4) When the window as shown below Figure is displayed, select file for upload and click “Open” button.

☞ Do not upload any other files except for WIZ108SR application firmware file. If you uploaded other files by accident, Configuration Tool cannot search out WIZ108SR so that uploading a correct one via Ethernet is impossible. In this case, you should erase code and data flash in W7100A and upload a correct file by using “WIZISP for iMCU W7100”.

☞ Don't turn power off while F/W is being uploaded.

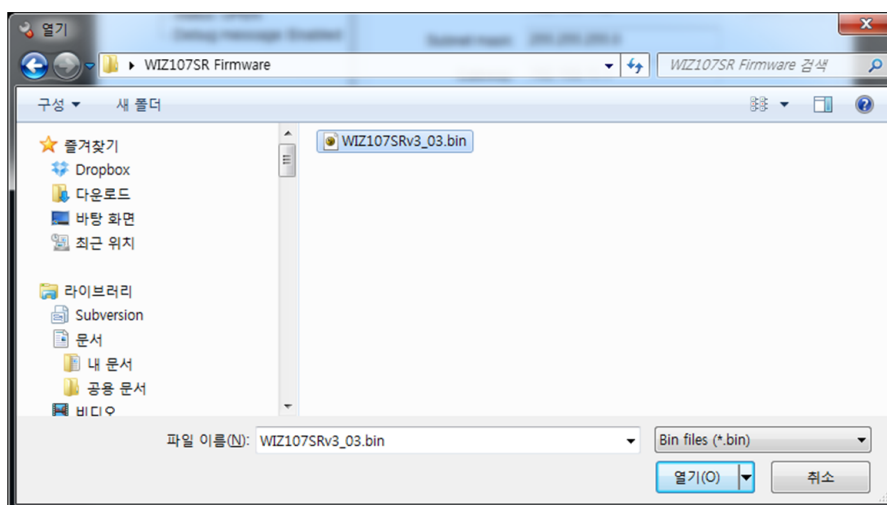

Figure 9. File open dialog box for Firmware uploading

5) When the firmware is uploaded successfully, the following message box will be shown.

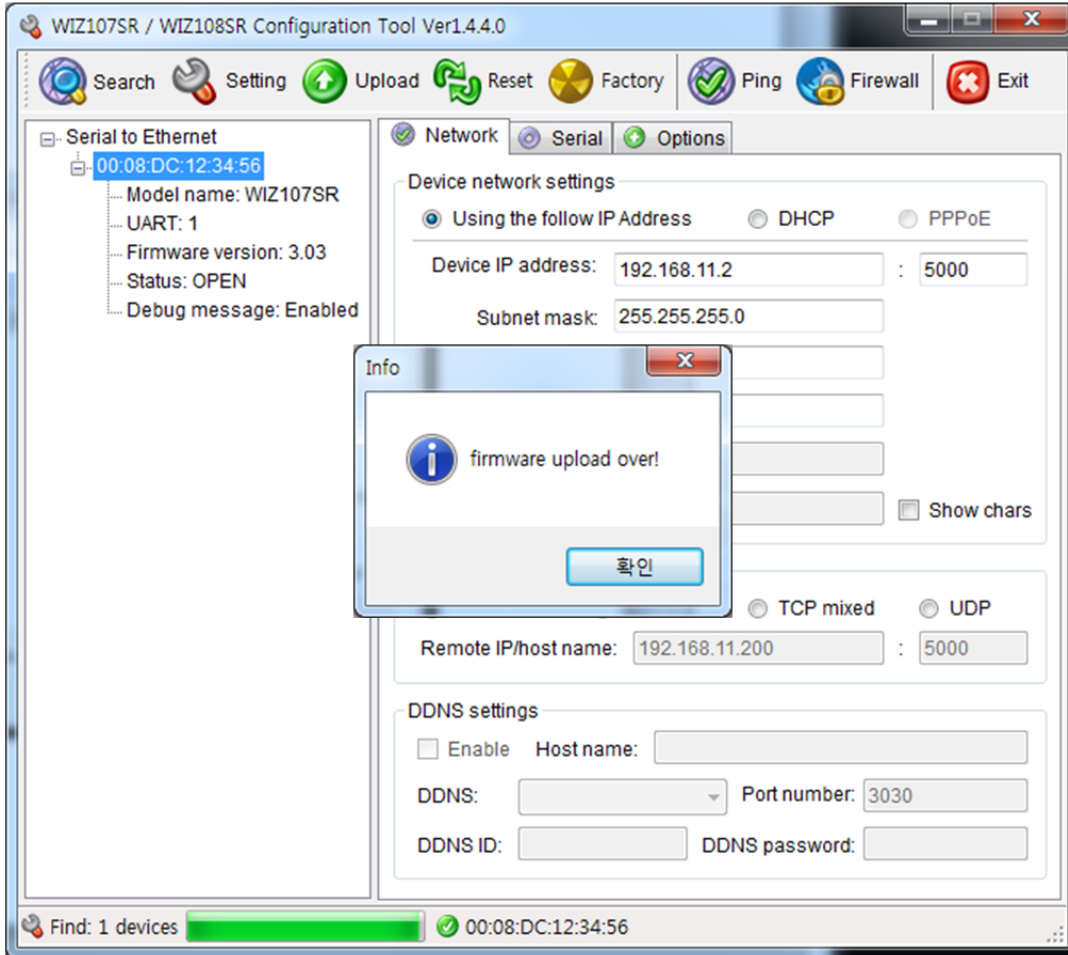

Figure 10. Firmware uploaded successfully

☞ If you try to upload the wrong version of firmware, the following message box will be displayed.

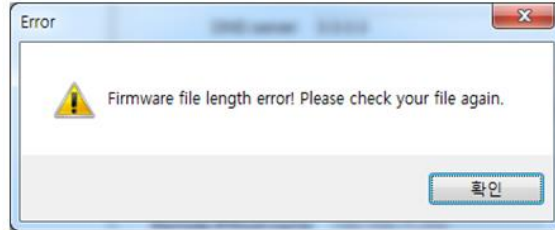

Figure 11. Error message about uploading different version firmware

Please check the firmware version. And upload the appropriate one according to the hardware version

Part #	Hardware Version	Available Firmware Version	Remark
WIZ108SR	V1.1 or below	V2.20 (the latest one)	If you upload the wrong firmware, the module may not work properly. There is no difference in all functions and features.
	V1.2	V3.03 - V3.14	
	V1.4 or above	V4.04 or above	

Table 5. Available firmware version with hardware version

3. Serial Configuration

3.1 Serial Command Format

If WIZ108SR is in serial configuration mode, users can use the following predefined commands to configure WIZ108SR via serial interface. The format of serial command is shown in Figure 12. Each command starts with a command name (2 characters) and ends with '\r\n'. If the data field is null, it means the command does a reading operation. Otherwise, the command do writing operation. Ones can get response in case of reading operation of Commands, the format of response is the same with Serial command format.

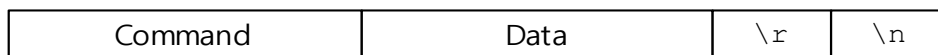

Figure 12. Serial command format

3.2 Serial Command List

The commands are listed in the following Table 5.

CMD	Data	Description
MC	--	MAC address (read only)
VR	--	Firmware version (read only)
MN	--	Model name (read only)
ST	--	Device status (read only) 0:OPEN, 1:CONNECT, 2:UPGRADE 3:ATMODE
IM	0:STATIC, 1:DHCP, 2:PPPOE	Obtain IP method
OP	0:CLIENT, 1:SERVER, 2:MIXED, 3:UDP	Operation mode
DD	1:ENABLE, 0:DISABLE	DDNS enable/disable flag
CP	1:ENABLE, 0:DISABLE	Connection password enable/disable flag
PO	0:RAW, 1:TELNET	Data transmission protocol (only raw data transmission is supported for current version)
DG	1:ENABLE, 0:DISABLE	Debug message output flag
KA	1:ENABLE, 0:DISABLE	Keep alive flag
KI	0 ~ 65535	Tx KeepAlive interval (0-65535ms)
KE	0 ~ 65535	KeepAlive enable interval (0-65535ms)
RI	0 ~ 65535	Reconnection interval (client mode only, 0-65535ms)
LI	192.168.11.2 (Default value)	Local IP address

SM	255.255.255.0 (Default value)	Subnet mask
GW	192.168.11.1 (Default value)	Gateway
DS	0.0.0.0 (Default value)	DNS server IP
LP	5000 (Default value)	Local port number
RP	5000 (Default value)	Remote host port number
RH	192.168.101.200 (Default value)	Remote host IP/name
BR	0:300bps, 1:600bps, 2:1200bps, 3:1800bps, 4:2400bps, 5:4800bps, 6:9600bps, 7:14400bps, 8:19200bps, 9:28800bps, 10:38400bps, 11:57600bps, 12:115200bps, 13:230400bps	Baud rate index
DB	0:7bit, 1:8bit	Data bit
PR	0:NONE, 1:ODD, 2:EVEN	parity
SB	0:1bit, 1:2bit	Stop bit
FL	0:NONE, 1:XON/XOFF, 2:CTS/RTS	Flow Control
IT	0 ~ 65535	Inactivity timer (0-65535sec)
PT	0 ~ 65535	Serial data packing interval (0-65535ms)
PS	0 ~ 255	Packing size (0-255)
PD	0 ~ 255	Packing indicator (0-255)
TE	1:Enable, 0:Disable	Software trigger enable flag
SS	010203 (Default value)	software trigger (fixed 3 bytes in hex)
NP	*****	Connection password (Max. 8 bytes)
SP	*****	Search password (Max. 8 bytes)
EC	1:Enable, 0:Disable	Show serial input echo or not WIZ108SR is not supported this CMD.
LG	--	Debug log message (read only)
ER	--	Error message (read only)
SV	--	Save setting message (After command, WIZ108SR needs some delay about 50ms)
RT	--	Reboot the device
UN	--	UART counter (read only)
EX	--	Exit from command mode
FR	--	Factory Reset

Table 6. Serial command list

The corresponding responses samples of serial commands are listed in the following Table 5.

Command		Input	Response
MC	Read only commands: Data field is null.	In ASCII: MC\r\n In HEX: 4D 43 0D 0A	MC00:08:DC:##:##:##\r\n
VR		In ASCII: VR\r\n In HEX: 56 52 0D 0A	VR1.4\r\n
MN		In ASCII: MN\r\n In HEX: 4D 4E 0D 0A	MNWIZ108SR\r\n
ST		In ASCII: ST\r\n In HEX: 53 54 0D 0A	STATMODE\r\n
UN		In ASCII: UN\r\n In HEX: 55 4E 0D 0A	UN1\r\n
LG		Users are not allowed to input this command. This command can only be displayed by system. See example on right side.	LGIP:192.168.11.2\r\n
ER	Users are not allowed to input this command. This command can only be displayed by system. See example on right side.	ERNOCOMMAND:kk\r\n	
IM	Null data	In ASCII: IM\r\n In HEX: 49 4D 0D 0A	IM0
	With data	In ASCII: IM0\r\n or IM1\r\n In HEX: 49 4D 31 0D 0A or ...	No Response
OP	Null data	In ASCII: OP\r\n In HEX: 4F 50 0D 0A	OP0
	With data	In ASCII: OP0\r\n or OP1\r\n or ... OP3\r\n In HEX: 4F 50 31 0D 0A or ...	No Response
DD	Null data	In ASCII: DD\r\n In HEX: 44 44 0D 0A	DD0\r\n
	With data	In ASCII: DD0\r\n or DD1\r\n In HEX: 44 44 31 0D 0A or ...	No Response
CP	Null data	In ASCII: CP\r\n	CP0\r\n

		In HEX: 43 50 0D 0A	
	With data	In ASCII: CP0\r\n or CP1\r\n In HEX: 43 50 31 0D 0A or ...	No Response
PO	Null data	In ASCII: PO\r\n In HEX: 50 4F 0D 0A	PO0\r\n
	With data	In ASCII: PO0\r\n or PO1\r\n In HEX: 50 4F 31 0D 0A or ...	No Response
DG	Null data	In ASCII: DG\r\n In HEX: 44 47 0D 0A	DG1\r\n
	With data	In ASCII: DG0\r\n or DG1\r\n In HEX: 44 47 31 0D 0A or ...	No Response
KA	Null data	In ASCII: KA\r\n In HEX: 4B 41 0D 0A	KA0\r\n
	With data	In ASCII: KA0\r\n or KA1\r\n In HEX: 4B 41 31 0D 0A or ...	No Response
KI	Null data	In ASCII: KI\r\n In HEX: 4B 49 0D 0A	KI0\r\n
	With data	In ASCII: KI100 \r\n In HEX: 4B 49 31 30 30 0D 0A	No Response
KE	Null data	In ASCII: KE\r\n In HEX: 4B 45 0D 0A	KE0\r\n
	With data	In ASCII: KE100\r\n In HEX: 4B 45 31 30 30 0D 0A	No Response
RI	Null data	In ASCII: RI\r\n In HEX: 52 49 0D 0A	RI0\r\n
	With data	In ASCII: RI100 \r\n In HEX: 52 49 31 30 30 0D 0A	No Response
LI	Null data	In ASCII: LI\r\n In HEX: 4C 49 0D 0A	LI192.168.11.2\r\n
	With data	In ASCII: LI192.168.11.20\r\n In HEX: 4C 49 31 39 32 2E 31 36 38 2E 31 31 2E 32 30 0D 0A	No Response
SM	Null data	In ASCII: SM\r\n In HEX: 53 4D 0D 0A	SM255.255.255.0\r\n
	With data	In ASCII: SM255.255.255.0\r\n In HEX: 53 4D 32 35 35 2E 32 35 35	No Response

		2E 32 35 35 2E 30 0D 0A	
GW	Null data	In ASCII: GW\r\n In HEX: 47 57 0D 0A	GW192.168.11.1\r\n
	With data	In ASCII: GW192.168.11.1\r\n In HEX: 47 57 31 39 32 2E 31 36 38 2E 31 31 2E 31 0D 0A	No Response
DS	Null data	In ASCII: DS\r\n In HEX: 44 53 0D 0A	DS192.168.11.22\r\n
	With data	In ASCII: DS1.2.3.4\r\n In HEX: 44 53 31 2E 32 2E 33 2E 34 0D 0A	No Response
LP	Null data	In ASCII: LP\r\n In HEX: 4C 50 0D 0A	LP5000\r\n
	With data	In ASCII: LP5000\r\n In HEX: 4C 50 35 30 30 30 0D 0A	No Response
RP	Null data	In ASCII: RP\r\n In HEX: 52 50 0D 0A	RP5000\r\n
	With data	In ASCII: RP5000\r\n In HEX: 52 50 35 30 30 30 0D 0A	No Response
RH	Null data	In ASCII: RH\r\n In HEX: 52 48 0D 0A	RH1.2.3.4\r\n
	With data	In ASCII: RH1.2.3.4\r\n In HEX: 52 48 31 2E 32 2E 33 2E 34 0D 0A	No Response
BR	Null data	In ASCII: BR\r\n In HEX: 42 52 0D 0A	BR11\r\n
	With data	In ASCII: BR11\r\n In HEX: 42 52 31 31 0D 0A	No Response
DB	Null data	In ASCII: DB\r\n In HEX: 44 42 0D 0A	DB1\r\n
	With data	In ASCII: DB1\r\n In HEX: 44 42 31 0D 0A	No Response
PR	Null data	In ASCII: PR\r\n In HEX: 50 52 0D 0A	PR0\r\n
	With data	In ASCII: PR0\r\n In HEX: 50 52 30 0D 0A	No Response

SB	Null data	In ASCII: SB\r\n In HEX: 53 42 0D 0A	SB0\r\n
	With data	In ASCII: SB0\r\n In HEX: 53 42 30 0D 0A	No Response
FL	Null data	In ASCII: FL\r\n In HEX: 46 4C 0D 0A	FL0\r\n
	With data	In ASCII: FL0\r\n In HEX: 46 4C 30 0D 0A	No Response
IT	Null data	In ASCII: IT\r\n In HEX: 49 54 0D 0A	IT0\r\n
	With data	In ASCII: IT100\r\n In HEX: 49 54 31 30 30 0D 0A	No Response
PT	Null data	In ASCII: PT\r\n In HEX: 50 54 0D 0A	PT0\r\n
	With data	In ASCII: PT100\r\n In HEX: 50 54 31 30 30 0D 0A	No Response
PS	Null data	In ASCII: PS\r\n In HEX: 50 53 0D 0A	PS0\r\n
	With data	In ASCII: PS0 \r\n In HEX: 50 53 30 0D 0A	No Response
PD	Null data	In ASCII: PD\r\n In HEX: 50 44 0D 0A	PD0\r\n
	With data	In ASCII: PD0 \r\n In HEX: 50 44 30 0D 0A	No Response
TE	Null data	In ASCII: TE\r\n In HEX: 54 45 0D 0A	TE0\r\n
	With data	In ASCII: TE1\r\n In HEX: 54 45 31 0D 0A	No Response
SS	Null data	In ASCII: SS\r\n In HEX: 53 53 0D 0A	SS2B2B2B\r\n
	With data	In ASCII: SS010101\r\n In HEX: 53 53 30 31 30 31 30 31 2B 2B 0D 0A	No Response
NP	Null data	In ASCII: NP\r\n In HEX: 4E 50 0D 0A	NP110\r\n
	With data	In ASCII: NP110 \r\n	No Response

		In HEX: 4E 50 31 31 30 0D 0A	
SP	Null data	In ASCII: SP\r\n In HEX: 53 50 0D 0A	SP110\r\n
	With data	In ASCII: SP110\r\n In HEX: 53 50 #31 31 30 0D 0A	No Response
EC	Null data	In ASCII: EC\r\n In HEX: 45 43 0D 0A	EC0\r\n
	With data	In ASCII: EC1 \r\n In HEX: 45 43 31 0D 0A	No Response
SV	Data field is null	In ASCII: SV\r\n In HEX: 53 56 0D 0A	No Response
RT		In ASCII: RT\r\n In HEX: 52 54 0D 0A	Reboot display
EX		In ASCII: EX\r\n In HEX: 45 58 0D 0A	No Response
FR		In ASCII: FR\r\n In HEX: 46 52 0D 0A	Reboot display

Table 5. Serial command response list

3.3 Serial Command Executing Example

Figure 13. shows an example with several commands executed. At first, WIZ108SR should be set into serial configuration mode (both hardware trigger and software trigger can be used).

For the WIZ108SR to enter into serial configuration mode, hardware trigger should be turned on and reset the WIZ108SR, and the software trigger code should be sent to change WIZ108SR into serial configuration mode.

In this example, the serial echo message is turned on and using software trigger to set WIZ108SR into serial configuration mode. And then, the user inputs command 'MC' with 'Enter' key pressed to read the MAC address of the WIZ108SR. You can find that the WIZ108SR responses with 'MC00:08:DC:01:02:03'. In the same way, we can read the IP address of WIZ108SR. This example also shows how to modify the parameters of WIZ108SR. After reading IP address, the user inputs 'LI192.168.11.20' with 'Enter' key pressed in hyper terminal. You can find that the IP address is set to '192.168.11.20' after 'LI' command executed correctly.

Attentions:

- 1) The 'SV' command must be executed if you want to save your new parameters.
- 2) The 'RT' command must be executed if you want to execute your new parameters
- 3) The 'EX' command must be executed if you want to leave the serial configuration

mode.

4) Example:

Refer to 1)~3), usually if you want to change the operation mode from Server mode to Client mode, you should input something like this:

OP0 ---->SV---->RT

Please, note that the data connection will be closed firmly once the WIZ108SR goes into serial configuration mode.

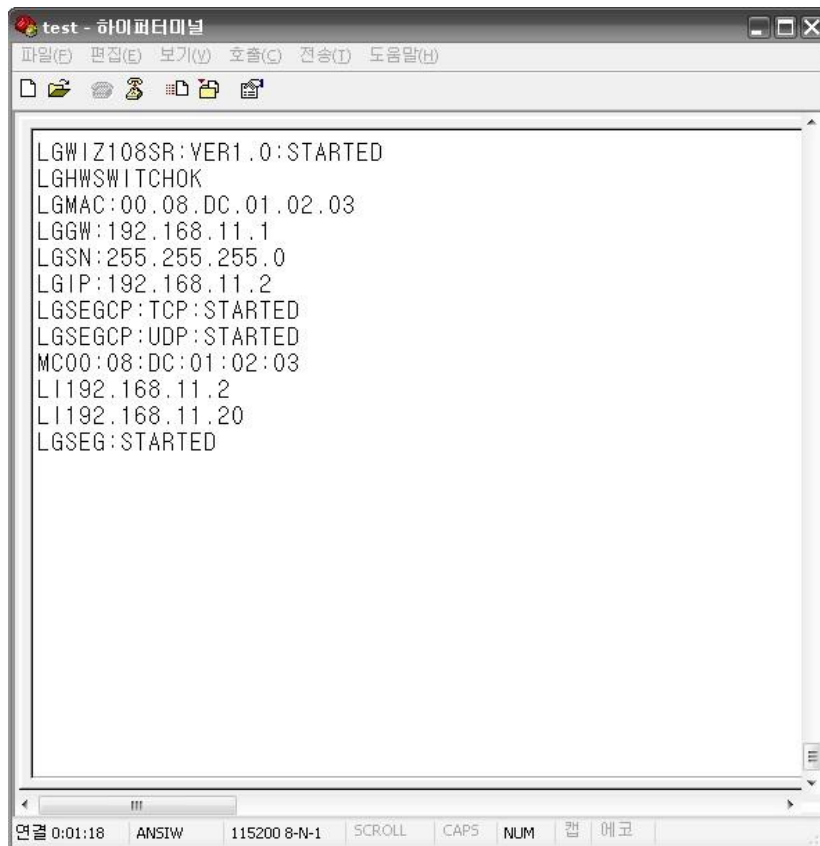

Figure 13. Serial command executing example

Attentions:

- 1) The 'SV' command must be executed with some delay (about 50ms) for WIZ108SR's stable operation.
- 2) Recommend to use the serial commands with some delay (about 10ms) for stable operation
- 3) After execute serial command, We recommend to check the parameters using response serial command like "LI\r\n".

Example

Input> LI192.168.11.2\r\n

Input> LI\r\n

Output> LI192.168.11.2

4. Hardware Specification

4.1 WIZ108SR Dimension

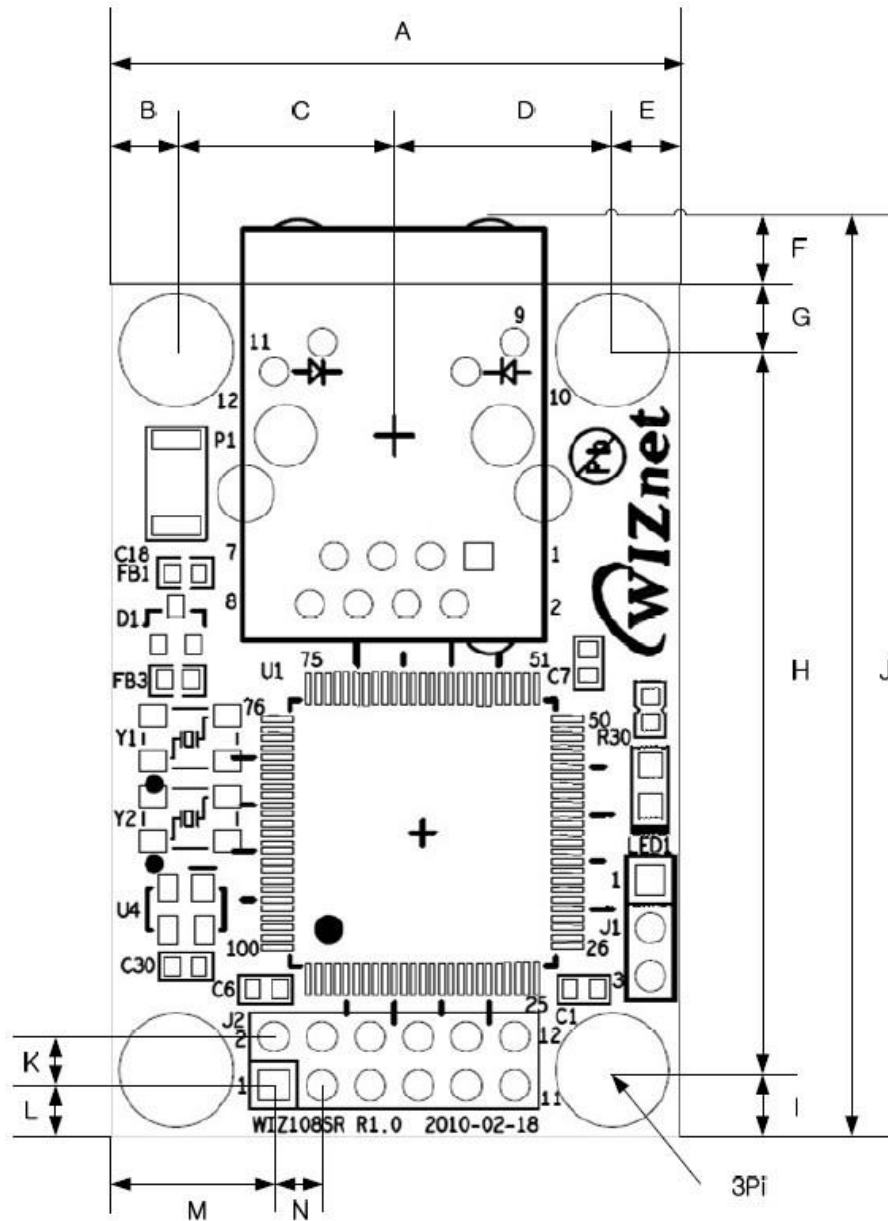

A	30.00	B	3.50	C	11.50	D	11.50
E	3.50	F	3.00	G	3.50	H	38.00
I	3.50	J	48.00	K	2.54	L	2.73
M	8.65	N	2.54				

Figure 14. WIZ108SR Dimensions (unit : mm)

4.2 WIZ108SR Signal Connection Method

4.2.1 RS-422 Interface Connection

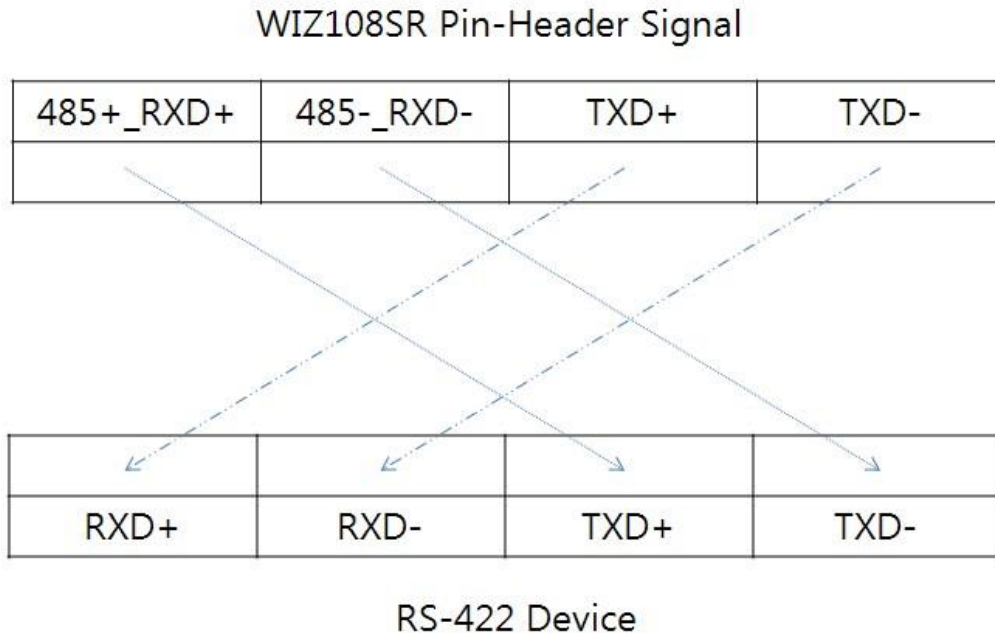

Figure 15. RS-422 Interface Connection Method

4.2.2 RS-485 Interface Connection

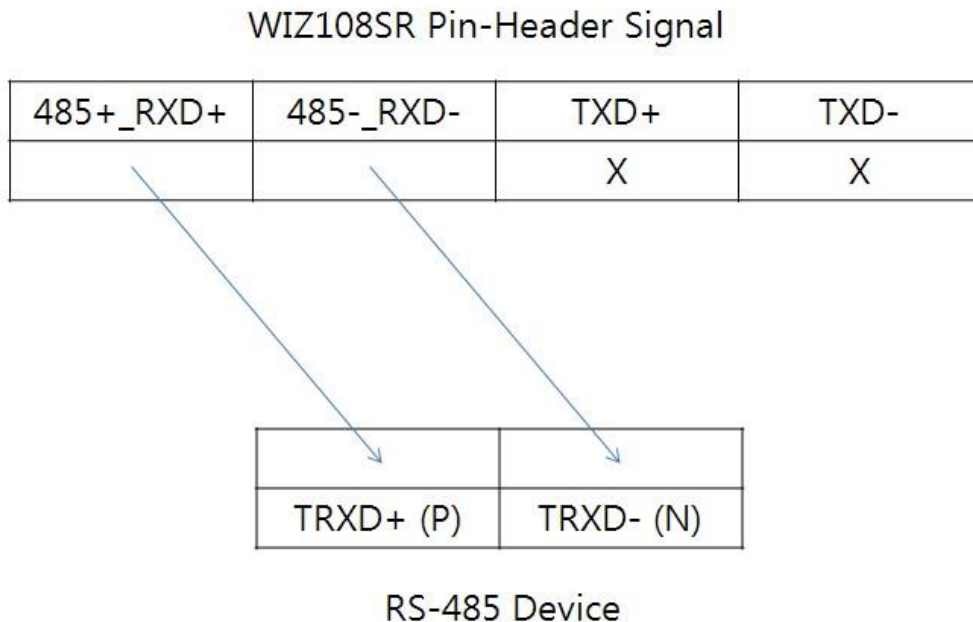
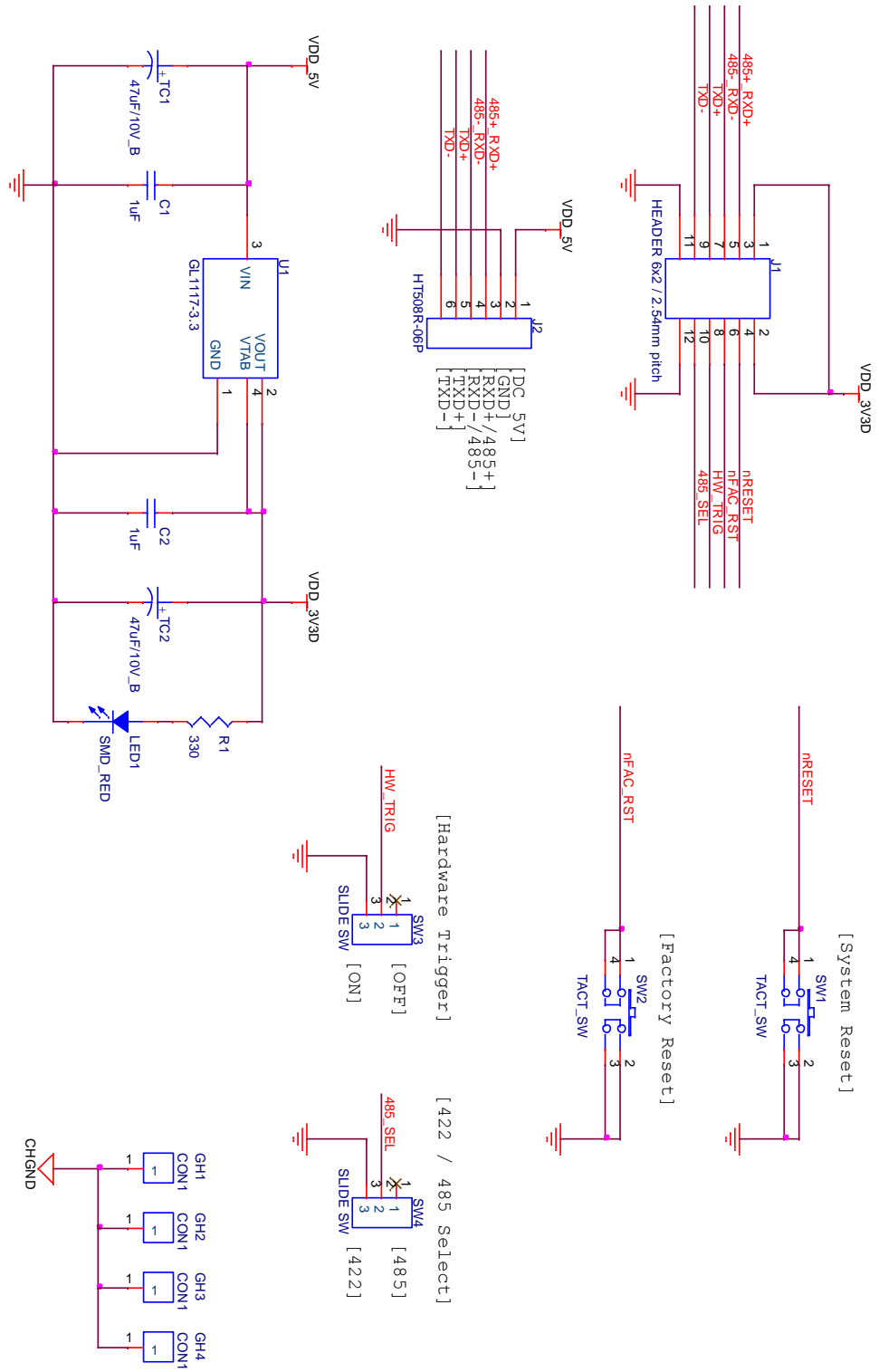

Figure 16. RS-485 Interface Connection Method

4.3 WIZ108SR Interface Board Schematic



Title	<Title>
Size	Document Number
A	<Doc>
Date:	Thursday, November 15, 2012
Sheet	2 of 2
Rev	1.0

Figure 17. WIZ108SR Interface Board Schematic

4.4 Booting Time

H/W version	Firmware Version	Booting Time
Rev 1.1	~ v1.93	70ms
	v2.1 ~ v2.13	70ms + (400ms)
	v2.14 ~	70ms
Rev 1.2	~ v3.04	70ms + (400ms)
	v3.06 ~ v3.14	70ms
Rev 1.4	V4.03 ~	70ms

Table 7. WIZ108SR's Booting Time

4.5 HW_TRIG PIN

The way of detection connect status is monitoring the HW_TRIG Pin. When the connection is established, HW_TRIG pin goes Low. And, it will go HIGH when connection is closed. Actually, this pin works both direction, like Input and Output.

In the initial time, this pin is INPUT for Hardware Trigger (for serial command mode).

After that, this pin is OUTPUT for connection status.

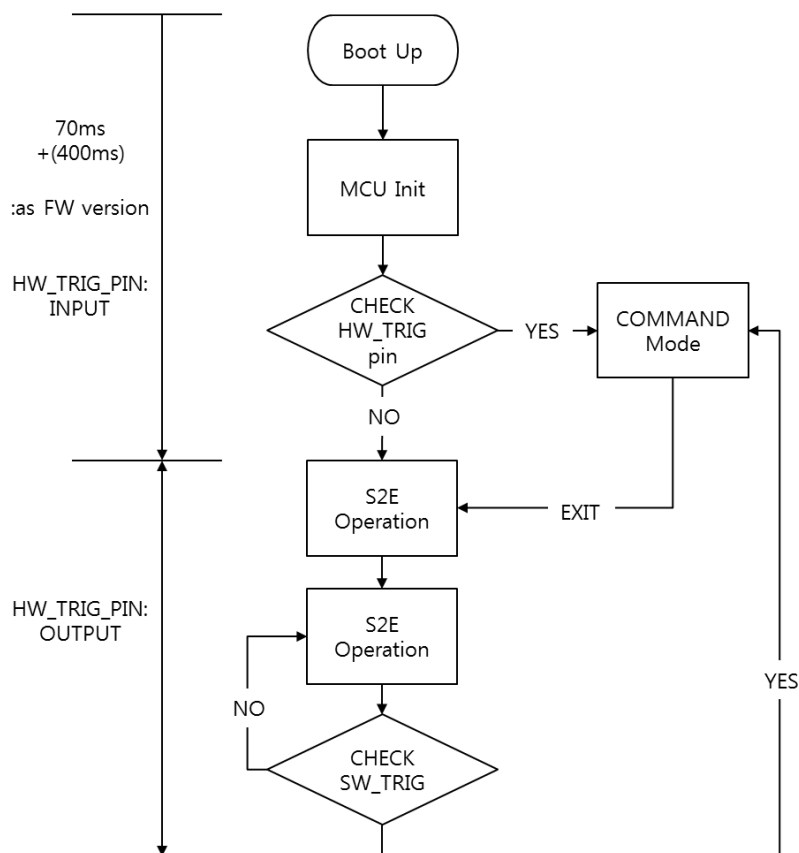

Figure 18 WIZ108SR's Operation Flow

5. Warranty

WIZnet Co., Ltd offers the following limited warranties applicable only to the original purchaser. This offer is non-transferable.

WIZnet warrants our products and its parts against defects in materials and workmanship under normal use for period of standard ONE(1) YEAR for the WIZ108SR board and labor warranty after the date of original retail purchase. During this period, WIZnet will repair or replace a defective products or part free of charge.

Warranty Conditions:

1. The warranty applies only to products distributed by WIZnet or our official distributors.
2. The warranty applies only to defects in material or workmanship as mentioned above in 6.Warranty. The warranty applies only to defects which occur during normal use and does not extend to damage to products or parts which results from alternation, repair, modification, faulty installation or service by anyone other than someone authorized by WIZnet Inc. ; damage to products or parts caused by accident, abuse, or misuse, poor maintenance, mishandling, misapplication, or used in violation of instructions furnished by us ; damage occurring in shipment or any damage caused by an act of God, such as lightening or line surge.

Procedure for Obtaining Warranty Service

1. Contact an authorized distributors or dealer of WIZnet Inc. for obtaining an RMA (Return Merchandise Authorization) request form within the applicable warranty period.
2. Send the products to the distributors or dealers together with the completed RMA request form. All products returned for warranty must be carefully repackaged in the original packing materials.
3. Any service issue, please contact to sales@wiznet.co.kr