

Assembly Instructions for - 37374

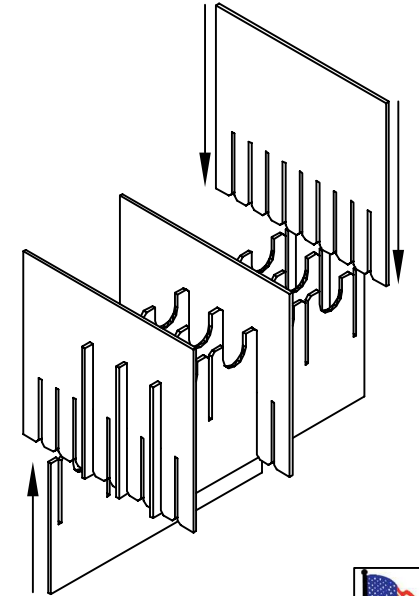
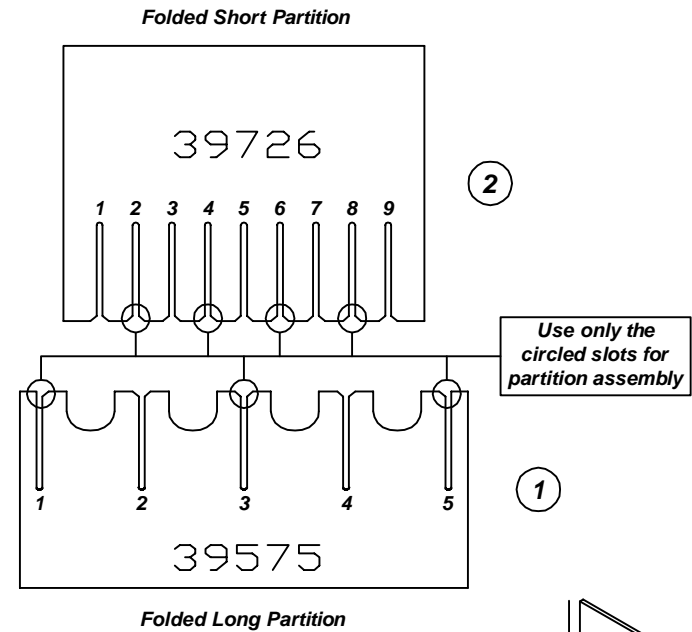
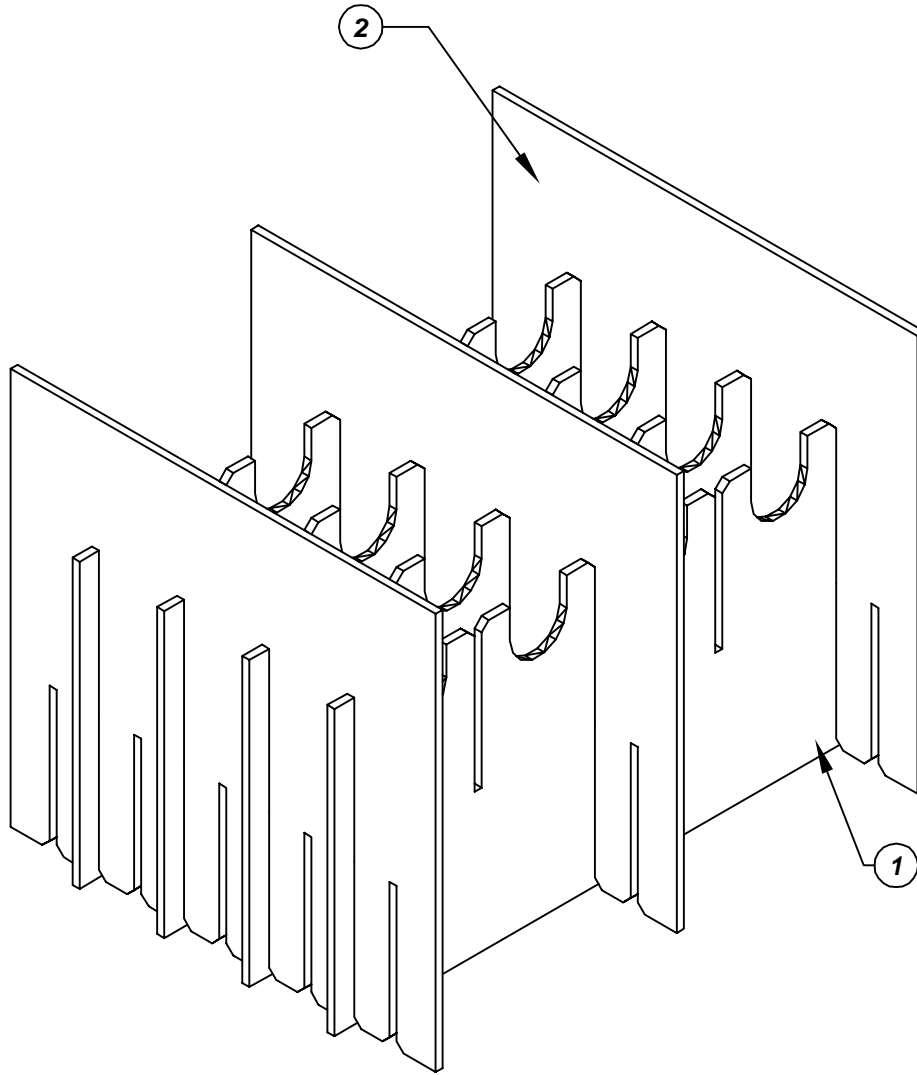

Made in America

F/N ①	Part # 39575	Dimensions: 20-1/4" x 18-5/8"	Description: 460/462/464-LP-20/40 Long Partition	Qty: 4
F/N ②	Part # 39726	Dimensions: 28-1/4" x 15"	Description: 464-SP-10 Short Partition	Qty: 3

37374 - 10 Cell Inplant Handler Cell Size - 14" x 8-1/8" x 2-3/4"

Notes:
For use with the following storage container & lid:
37526 - Storage Container
37554 - Lid

PROTEKTIVE PAK
13520 MONTE VISTA AVENUE, CHINO, CA 91710
PHONE (909) 627-2578, FAX (909) 363-7331
ProtektivePak.com



DRAWING NUMBER
IPH-37374

DATE
Dec. 2007