



## 1 Features

- The AWA24S is a 2.4-GHz Direct Sequence Spread Spectrum (DSSS) radio module which includes the Cypress radio transceiver CyFi™ CYRF7936 and an integrated PA
- Operates in the unlicensed worldwide Industrial, Scientific and Medical (ISM) band (\*2.407 GHz–2.467 GHz)
- Less than 220 mA operating current @ 20 dBm
- Receive sensitivity up to -93 dBm
- Sleep Current ~ 15 µA
- Outdoor LOS range of more than 1Km.
- DSSS data rates up to 250 kbps, GFSK data rate of 1 Mbps
- Framing, Length, CRC16.
- Fast Startup and Fast Channel Changes
- Separate 16-byte Transmit and Receive FIFOs
- Auto Rate™ - dynamic data rate reception
- Receive Signal Strength Indication (RSSI)
- 4-MHz SPI microcontroller interface
- No proprietary software required
- Serial Peripheral Interface (SPI) control while in sleep mode
- Vertical or horizontal mounting
- Operating voltage 2.7-3.3 volts
- Operating temperature from 0 to 70°C
- Size: 25.4 mm X 20.30mm (0.8" x 1.0")
- Weight: ~ 3 grams
- Compliance  
FCC Modular Approval Grant to meet FCC Part 15, EU , EN 300 328-1, EN 301 489-1 and EN 301 489-7, Industry Canada RSS-210 standards
- An FCC Module Approval (MA) Grant provides customers significant cost savings, by allowing customers to adopt the AWA24S FCC ID into their own products

## 2 Functional Description

Artaflex AWA24S is based on CyFi™ Transceiver a Radio IC designed for low-power embedded wireless applications. Combined with Cypress's PSoC programmable system-on-chip and a CyFi network protocol stack AWA24S can be used to implement a complete CyFi wireless system.

The AWA24S is tested for functional operation and is FCC/ETSI (EU)/Industry Canada certified.

The AWA24S is available in a small PCB design and can be mounted horizontally or vertically to the device PCB via a 12-pin header / Socket.

## 3 Application

### • PC Human Interface Devices (HID)

- Wireless Keyboards and Mice
- VOIP and Wireless Headsets
- Wireless Gamepads
- Remote Control

### • White Goods (Smart Appliances)

- Air Conditioners
- Kitchen Compactors
- Dishwashers
- Washers
- Dryers

### • Consumer

- Sports and Leisure Equipment
- Remote Controls
- Audio Subwoofer
- Presenter Tools
- Locator Alarms
- Toys

### • Building/Home Automation

- Automatic Meter Readers (AMR)
- On-Site Paging Systems
- Garage door opener
- Alarm and Security
- Lighting Control
- Climate Control
- Fan Control

### • Industrial Control

- Active RFID and asset tracking systems
- Inventory Management
- Point-of-sale systems
- Factory Automation
- Data Acquisition

### • Transportation

- Remote Keyless Entry with acknowledgement (RKE)
- Airline Baggage Tracking
- Diagnostics



## 4 Functional Overview

The AWA24S Module provides a complete SPI to RF antenna wireless MODEM. The module is designed to implement wireless device links operating in the worldwide 2.4-GHz ISM frequency band. It is intended for systems compliant with world-wide regulations covered by Europe ETSI EN 301 489-1, ETSI EN 301 489-7, & ETSI EN 300 328-1, USA FCC Part 15 and Industry Canada RSS-210 standards.

The module contains a 2.4-GHz 1-Mbps GFSK radio transceiver, packet data buffering, packet framer, DSSS baseband controller, Received Signal Strength Indication (RSSI), and SPI interface for data transfer and device configuration.

The radio supports 60 discrete 1-MHz channels. In DSSS modes the baseband performs DSSS spreading/de-spreading, while in GFSK Mode (1 Mb/s - GFSK) the baseband performs Start of Frame (SOF), End of Frame (EOF) detection and CRC16 generation and checking.

When in receive mode, with packet framing enabled, the device is always ready to receive data transmitted at any of the supported bit rates, except SDR, enabling the implementation of mixed-rate systems in which different devices use different data rates. This also enables the implementation of dynamic data rate systems, which use high data rates at shorter distances and/or in a low-moderate interference environment, and change to lower data rates at longer distances and/or in high interference environments.

### 4.1 Link Layer Modes

The AWA24S module supports the following data packet framing features:

**SOP** – Packets begin with a 2-symbol Start of Packet (SOP) marker. This is required in GFSK and 8DR modes, but is optional in DDR mode and is not supported in SDR mode; if framing is disabled then an SOP event is inferred whenever two successive correlations are detected. The SOP\_CODE\_ADR code used for the SOP is different from that used for the “body” of the packet and if desired may be a different length. SOP must be configured to be the same length on both sides of the link.

**EOP** – There are two options for detecting the end of a packet. If SOP is enabled, then a packet length field may be enabled. GFSK and 8DR must enable the length field. This is the first 8-bits after the SOP symbol, and is transmitted at the payload data rate. If the length field is enabled, an End of Packet (EOP) condition is inferred after reception of the number of bytes defined in the length field, plus two bytes for the CRC16 (if enabled—see below). The alternative to using the length field is to infer an EOP condition from a configurable number of successive non-correlations; this option is not available in GFSK mode and is only recommended to enable when using SDR mode.

**CRC16** – The device may be configured to append a 16-bit CRC16 to each packet. The CRC16 uses the USB CRC polynomial with the added programmability of the seed. If enabled, the receiver will verify the calculated CRC16 for the payload data against the received value in the CRC16 field. The starting value for the CRC16 calculation is configurable, and the CRC16 transmitted may be calculated using either the loaded seed value or a zero seed; the received data CRC16 will be checked against both the configured and zero CRC16 seeds.

CRC16 detects the following errors:

- Any one bit in error
- Any two bits in error (no matter how far apart, which column, and so on)
- Any odd number of bits in error (no matter where they are)
- An error burst as wide as the checksum itself

### 4.2 Packet Buffers

All data transmission and reception utilizes the 16-byte packet buffers—one for transmission and one for reception.

The transmit buffer allows a complete packet of up to 16-bytes of payload data to be loaded in one burst SPI transaction, and then transmitted with no further micro controller intervention. Similarly, the receive buffer allows an entire packet of payload data up to 16 bytes to be received with no firmware intervention required until packet reception is complete.

The AWA24S module supports packet length of up to 40 bytes; interrupts are provided to allow a micro controller to use the transmit and receive buffers as FIFOs. When transmitting a packet longer than 16 bytes, the micro controller can load 16-bytes initially, and add further bytes to the transmit buffer as transmission of data creates space in the buffer. Similarly, when receiving packets longer than 16 bytes, the micro controller must fetch received data from the FIFO periodically during packet reception to prevent it from overflowing.



4.3 Auto Transaction Sequencer (ATS)

AWA24S does not support ATS due to inherent hardware limitations. A firmware based ATS scheme can be implemented instead to get the same functionality.

4.4 Data Rates

By combining the DATA\_CODE\_ADR code lengths and data transmission modes described above, the AWA24S supports the following modes and data rates.

Table 1 - Data Rates

RF Transmission Mode	Raw Data Rate kbps
GFSK	1,000.00
32-Chip 8DR	250.00
64-chip 8DR <sup>[2]</sup>	125.00
32-chip DDR <sup>[3]</sup>	62.50
64-chip DDR <sup>[3]</sup>	31.25
64-chip SDR <sup>[2,3]</sup>	15.63

5 SPI Communication

The AWA24S has an SPI interface supporting communications between an application MCU and one or more slave devices (including the AWA24S). The SPI interface supports single-byte and multi-byte serial transfers using either 4-pin or 3-pin interfacing. The SPI communications interface consists of Slave Select ( $\overline{SS}$ ), Serial Clock (SCK), and Master Out- Slave In (MOSI), Master In-Slave Out (MISO), or Serial Data (SDAT).

The SPI communications is as follows:

- Command Direction (bit 7) = “1” enables SPI write transaction. A “0” enables SPI read transactions.
- Command Increment (bit 6) = “1” enables SPI auto address increment. When set, the address field automatically increments at the end of each data byte in a burst access, otherwise the same address is accessed.
- Six bits of address.
- Eight bits of data.

The device receives SCK from an application MCU on the SCK pin. Data from the application MCU is shifted in on the MOSI pin. Data to the application MCU is shifted out on the MISO pin. The active-low Slave Select ( $\overline{SS}$ ) pin must be asserted to initiate an SPI transfer.

The application MCU can initiate SPI data transfers via a multi byte transaction. The first byte is the Command/Address byte, and the following bytes are the data bytes as shown in Figure 2 through Figure 5.

The SPI communications interface has a burst mechanism, where the first byte can be followed by as many data bytes as desired. A burst transaction is terminated by de-asserting the slave select ( $\overline{SS} = 1$ ).

The SPI communications interface single read and burst read sequences are shown in Figure 3 and Figure 4, respectively.

The SPI communications interface single write and burst write sequences are shown in Figure 5 and Figure 6, respectively.

This interface may optionally be operated in a 3-pin mode with the MISO and MOSI functions combined in a single bidirectional data pin (SDAT). When using 3-pin mode, user firmware should ensure that the MOSI pin on the MCU is in a high impedance state except when MOSI is actively transmitting data.

The device registers may be written to or read from 1 byte at a time, or several sequential register locations may be written/read in a single SPI transaction using incrementing burst mode. In addition to single byte configuration registers, the device includes register files; register files are FIFOs written to and read from using non-incrementing burst SPI transactions.

The IRQ pin function may optionally be multiplexed onto the MOSI pin; when this option is enabled the IRQ function is not available while the  $\overline{SS}$  pin is low. When using this configuration, user firmware should ensure that the MOSI pin on the AWA24S is in a high impedance state whenever the  $\overline{SS}$  pin is high.

The SPI interface is not dependent on the internal 12-MHz clock, and registers may therefore be read from or written to while the device is in sleep mode, and the 12-MHz oscillator disabled.

**Figure 2 – SPI Transaction Format**

Bit #	Byte 1			Byte 1+N
	7	6	[5:0]	
Bit Name	DIR	INC	Address	
			Data	

**Figure 3 - SPI Single Read Sequence**

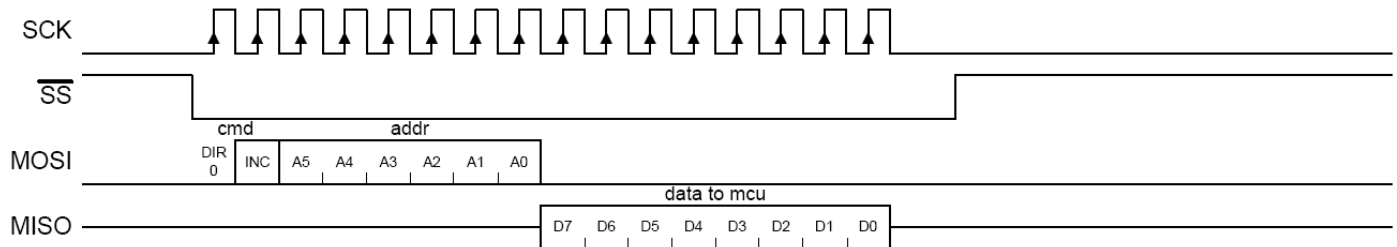

**Figure 4 - SPI Incrementing Burst Read Sequence**

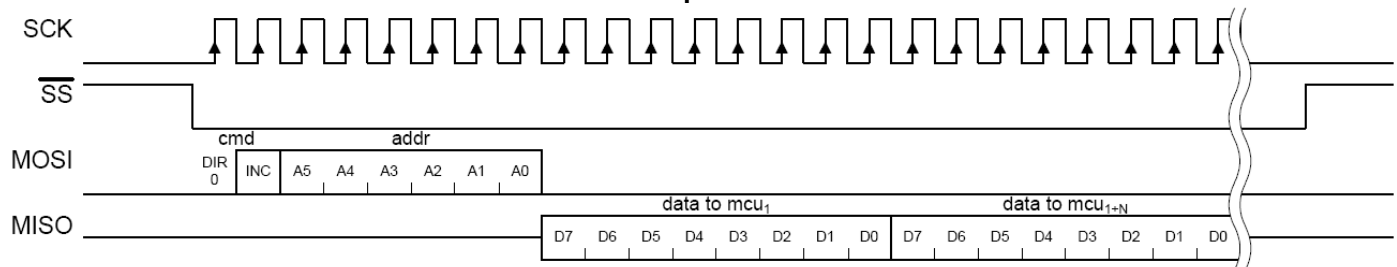

**Figure 5 - SPI Single Write Sequence**

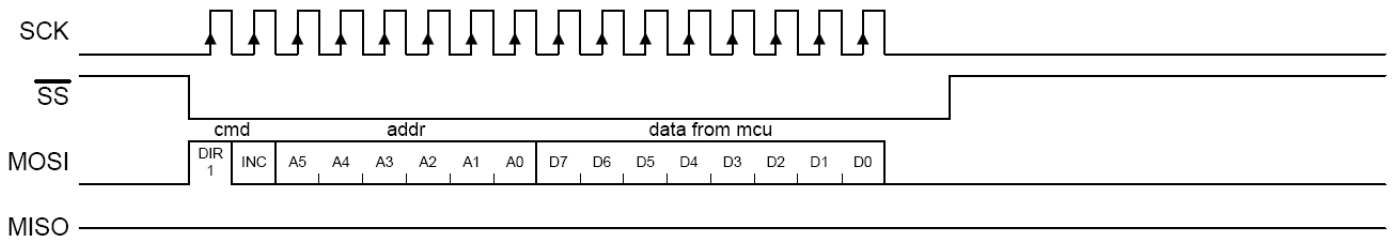

**Figure 6 - SPI Incrementing Burst Write Sequence**

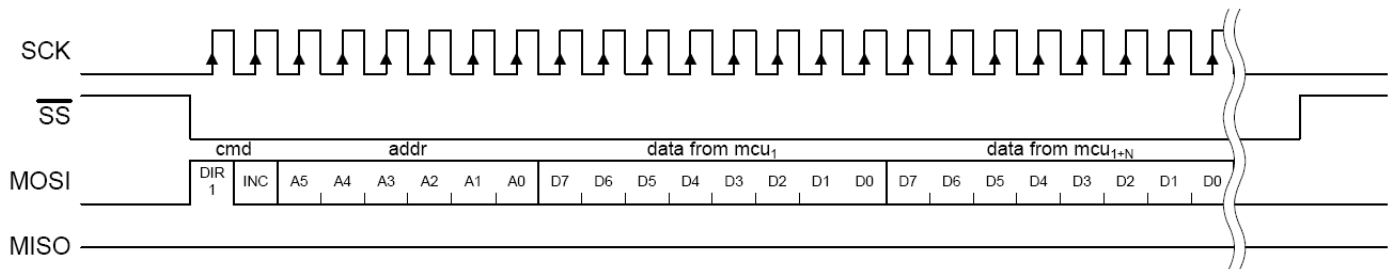

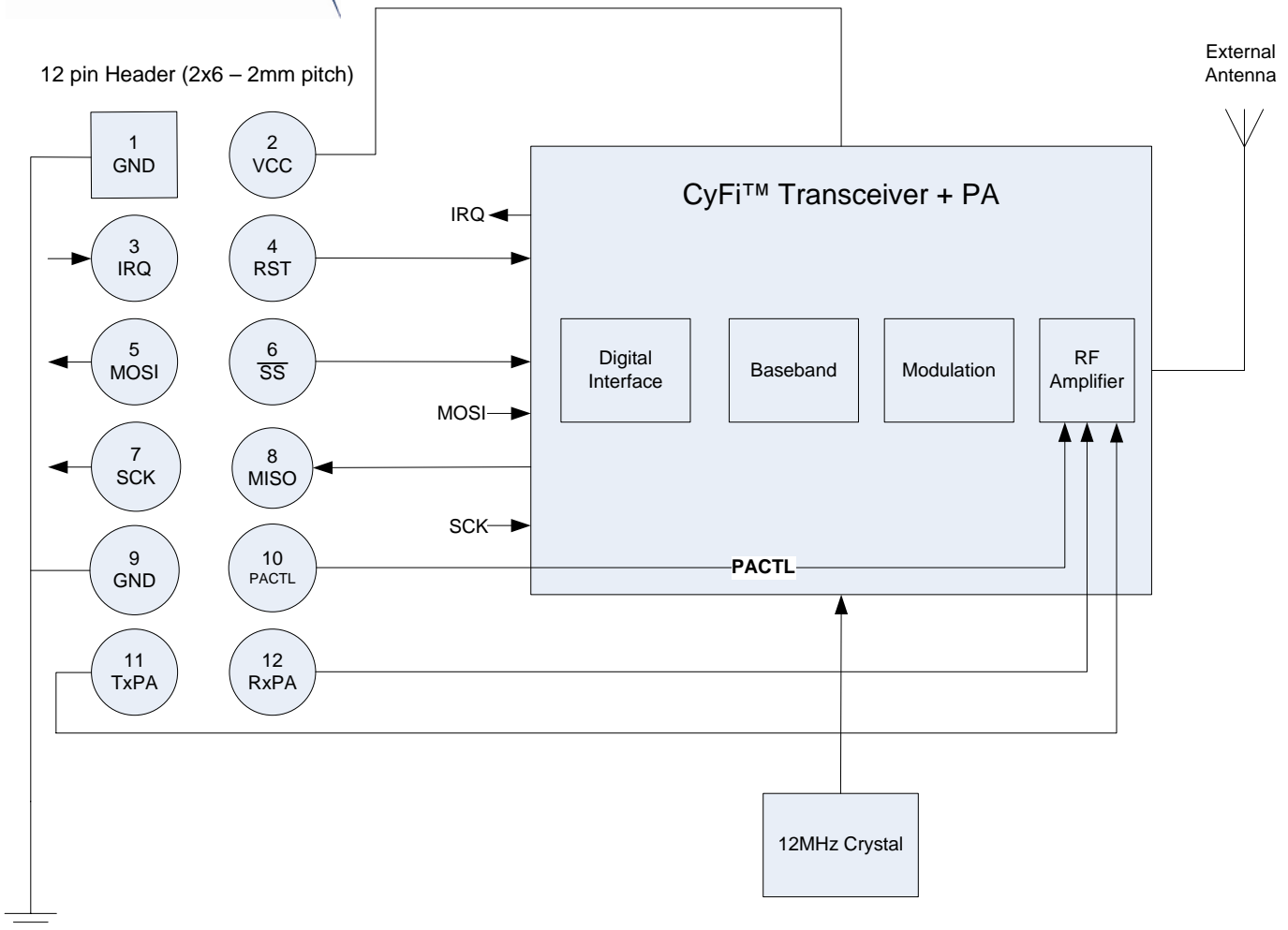

Figure 1 - Module Block Diagram

## 6 Power Management

The operating voltage of the module is 3.3V DC, which is applied to the  $V_{cc}$  (pin 2) on the connector. The device can be shutdown to a fully static sleep mode by writing to the  $PACTL = 0$ ,  $TXPA = 0$ ,  $RXPA = 0$ ,  $FRC\ END = 1$  and  $END\ STATE = 000$  bits in the  $XACT\_CFG\_ADR$  register over the SPI interface. The module will enter into sleep mode within 35- $\mu$ s after the last SCK positive edge at the end of this SPI transaction. Alternatively, the module may be configured to automatically enter sleep mode after completing packet transmission or reception. When in sleep mode, the on-chip oscillator is stopped, but the SPI interface remains functional. The module will wake from sleep mode automatically when commanded to enter transmit or receive mode. When resuming from sleep mode, there is a short delay while the oscillator restarts. The CyFi chip may be configured to assert the IRQ pin when the oscillator has stabilized. The module should always be set up in receive before going to sleep by setting the levels on TXPA, RXPA, PACTL pins as mentioned in Table-2.



### 7 Low Noise Amplifier (LNA) and Received Signal Strength Indication (RSSI)

The gain of the receiver may be controlled directly by clearing the AGC EN bit and writing to the Low Noise Amplifier (LNA) bit of the RX\_CFG\_ADR register. When the LNA bit is cleared, the receiver gain is reduced by approximately 20 dB, allowing accurate reception of very strong received signals (for example when operating a receiver very close to the transmitter). Approximately 30 dB of receiver attenuation can be added by setting the Attenuation (ATT) bit; this allows data reception to be limited to devices at very short ranges. Disabling AGC and enabling LNA is recommended for static long range application. When the module is in receive mode the RSSI\_ADR register returns the relative signal strength of the on-channel signal power.

When receiving, the module will automatically measure and store the relative strength of the signal being received as a 5-bit value. An RSSI reading is taken automatically when the SOP is detected. In addition, a new RSSI reading is taken every time the previous reading is read from the RSSI\_ADR register, allowing the background RF energy level on any given channel to be easily measured when RSSI is read when no signal is being received. A new reading can occur as fast as once every 12 μs.

### 8 RF Amplifier Stage

The RF Amplifier used in this module is a GaAs MMIC. This device realizes high efficiency, high gain and high output power, housed in a 6-pin plastic package TSON (Thin small Out-line Non Leaded). It has a very low shut down current (5uA) as well as a very high power efficiency (up to 60%), these features enables the module to work longer in a power sensitive applications.

The Tx and Rx operations of the additional Amplifier circuitry on this module is controlled by using Pin 11(TXPA), Pin 12 (RXPA) and Pin 10 (PACTL) on the 12 Pin Header Interface.

For a typical Full power Amplifier application, TXPA and PACTL pins can be tied together as they need the same logic levels for RX/TX control. The RF power can be set by setting different power levels in the TX\_CFG\_ADR register. The RF specs on page 11 of this data sheet describes the TX power levels available with this software control. PACTL will require a strong current drive as it can sink up to 10mA of current when biased at 3.3V

Amplifier RF Power can also be changed by controlling the voltage level at PACTL (0.5V-3.3V) independently. Biasing 3.3V at "PACTL" will set up the power to the maximum. A "0V" at PACTL will bring only the Amplifier stage into a shutdown mode. . All three pins (Pin 10,11,12) are required to control the amplifier in a proper manner. PACTL should always be set to 0V in a receive mode.

Table 2 – Radio Mode

Radio Mode	TXPA (Pin 11)	RXPA (Pin 12)	*PACTL (Pin 10)
Receive	Low (0V)	High (3.3V)	0V
Transmit	High (3.3V)	Low (0v)	0.5V – 3.3V

UNT\_0380\_Mode Control

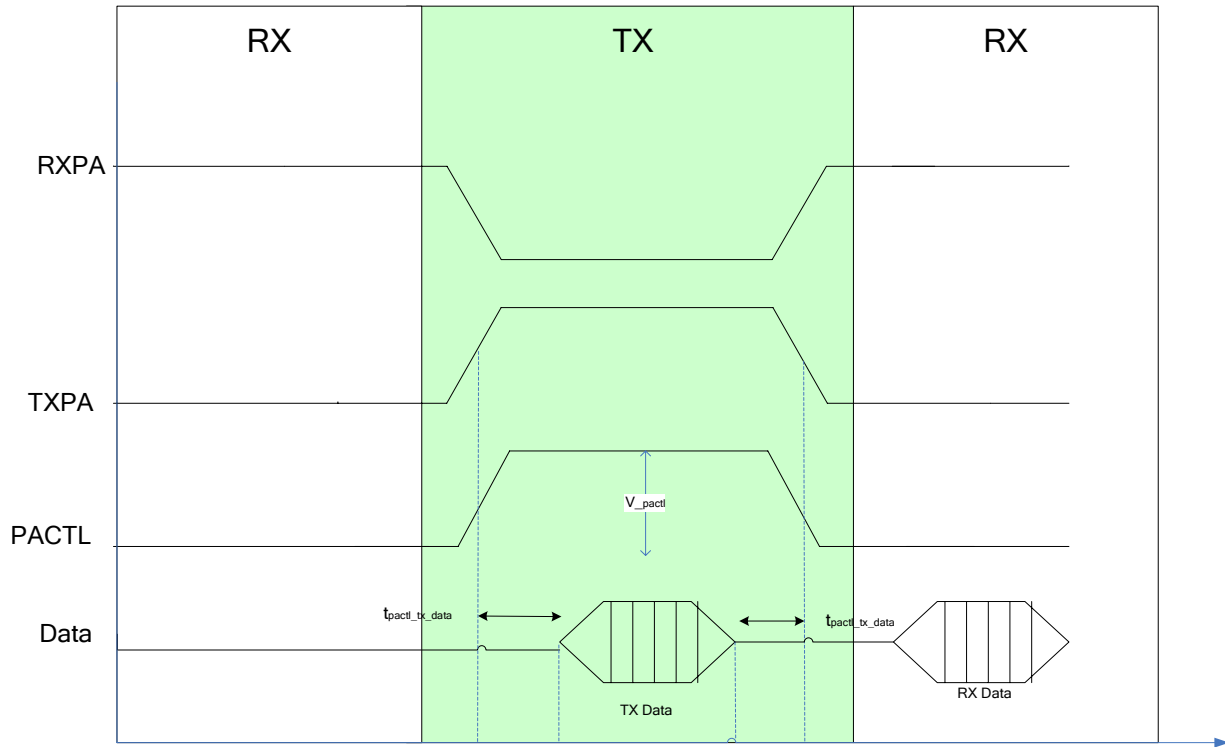

$t_{pactl\_tx\_data} = 1\mu\text{Sec}$   
 $V_{pactl} = 0.5 - 3.3\text{V}$

Changing Mode From  
Receive Data to Transmit Data

**Figure 2 – PA Module Timing Diagram**





**9 Absolute Maximum Ratings**

Storage Temperature..... -65°C to +150°C  
 Ambient Temperature with Power Applied ..... -55°C to +125°C  
 Supply Voltage on any power supply pin relative to .....  $V_{SS} - 0.3V$  to  $+3.9V$   
 DC Voltage to Logic Inputs<sup>[3]</sup>..... -0.3V to  $V_{IO} + 0.3V$   
 DC Voltage applied to Outputs in High-Z State ..... -0.3V to  $V_{IO} + 0.3V$   
 Static Discharge Voltage (Digital)<sup>[4]</sup>..... >2000V  
  
 PACTL Bias..... 3.7V  
 Static Discharge Voltage (RF)<sup>[4]</sup>..... 1100V

**10 Operating Conditions**

$V_{CC}$ ..... 2.7V to 3.6V  
 $T_A$  (Ambient Temperature under Bias)..... 0°C to +70°C  
 Ground Voltage..... 0V  
 $F_{OSC}$  (Crystal Frequency)..... 12 MHz  $\pm 30$  ppm

**11 DC Characteristics (T = 25°C,  $V_{CC} = 3V$ ,  $f_{OSC} = 12.000$  MHz, \*PA = 7)**

**Table 3 - DC Characteristics**

Parameter	Description	Conditions	Min.	Typ.	Max.	Unit
$V_{CC}$	Power Supply Voltage	0 to 70°C	2.5		3.6	V
$V_{IO}$	Voltage applied to I/O				$V_{CC} + 0.7$	V
$I_{synth}$	$I_{CC}$ during Synth Start			8.4		mA
<b>TX</b> $I_{CC5}$	$I_{CC}$ during Transmit	*PACTL = 3.3V	185	195	240	mA
<b>RX</b> $I_{CCoff}$	$I_{CC}$ during Receive	LNA off, ATT on		20		mA
<b>RX</b> $I_{CCon}$	$I_{CC}$ during Receive	LNA on, ATT off		23		mA
$I_{SB}$	Sleep Mode Current $I_{CC}$		8	13.8	50.0	$\mu A$

12 AC Characteristics<sup>[5]</sup>

Table 4 – SPI Interface<sup>[6]</sup>

Parameter	Description	Min.	Typ.	Max.	Unit
t <sub>SCK_CYC</sub>	SPI Clock Period	238.1			nS
t <sub>SCK_HI</sub>	SPI Clock High Time	100			nS
t <sub>SCK_LO</sub>	SPI Clock Low Time	100			nS
t <sub>DAT_SU</sub>	SPI Input Data Set-up Time	25			nS
t <sub>DAT_HLD</sub>	SPI Input Data Hold Time	10			nS
t <sub>DAT_VAL</sub>	SPI Output Data Valid Time	0		50	nS
t <sub>DAT_VAL_TRI</sub>	SPI Output Data Tri-state (MOSI from Slave Select Deassert)			20	nS
t <sub>SS_SU</sub>	SPI Slave Select Set-up Time before first positive edge of SCK <sup>[7]</sup>	10			nS
t <sub>SS_HLD</sub>	SPI Slave Select Hold Time after last negative edge of SCK	10			nS
t <sub>SS_PW</sub>	SPI Slave Select Minimum Pulse Width	20			nS
t <sub>SCK_SU</sub>	SPI Slave Select Set-up Time	10			nS
t <sub>SCK_HLD</sub>	SPI SCK Hold Time	10			nS
t <sub>RESET</sub>	Minimum RST pin pulse width	10			nS

Figure 7 - SPI Timing

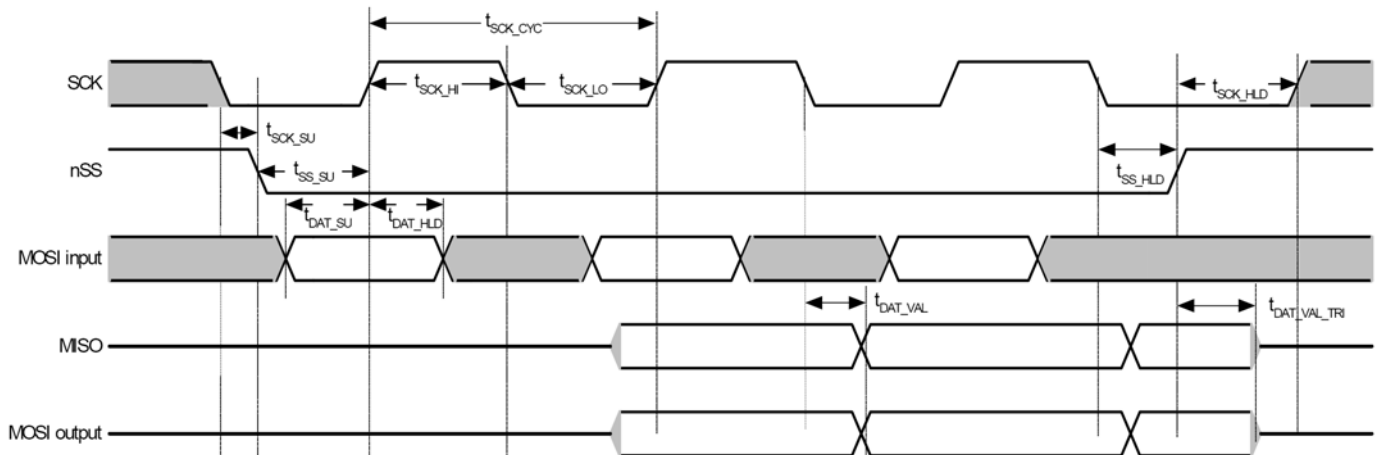

Notes

[5] AC values are not guaranteed if voltage on any pin exceeds V<sub>IO</sub>.

[6] C<sub>LOAD</sub> = 30 pF.

[7] SCK must start low at the time  $\overline{SS}$  goes low, otherwise the success of SPI transactions are not guaranteed.

**Table 5 – Radio Parameters**

Parameter Description	Conditions	Min.	Typ.	Max.	Unit
RF Frequency Range		2.407		2.467	GHz
<b>Receiver</b> (T=25°C, VCC = 3.0V, f <sub>osc</sub> = 12.000000MHz, BER < 1E-3)					
Sensitivity 125kbps 64-8DR	BER 1E-3		-93		dBm
Sensitivity 250-kbps 32-8DR	BER 1E-3		-89		dBm
Sensitivity	CER 1E-3	-80	-83		dBm
Sensitivity GFSK	BER 1E-3, ALL SLOW = 1		-80		dBm
LNA gain			22.8		dB
ATT gain			-31.7		dB
Maximum Received Signal	LNA On	-15	-6		dBm
RSSI value for PWR <sub>in</sub> -60 dBm	LNA On		21		Count
RSSI slope			1.9		dB/Count
<b>Receive Spurious Emission</b>					
800 MHz	100-kHz ResBW		-79		dBm
1.6GHz	100-kHz ResBW		-71		dBm
3.2 GHz	100-kHz ResBW		-65		dBm
<b>Transmitter</b> (T = 25°C, VCC = 3.0V, *PACTL = 3.3V)					
Maximum RF Transmit Power	*PA = 7	+19	+20	+21	dBm
Maximum RF Transmit Power	*PA = 6	16	17	+18	dBm
Maximum RF Transmit Power	*PA = 5	13	14	15	dBm
Maximum RF Transmit Power	*PA = 4	9	11	12	dBm
Maximum RF Transmit Power	*PA = 3	7	8	10	dBm
Maximum RF Transmit Power	*PA = 2	4	5	7	dBm
Maximum RF Transmit Power	*PA = 1	-2	-1	0	dBm
Maximum RF Transmit Power	*PA = 0	-7	-5	-2	dBm
RF Power Control Range			39		dB
RF Power Control Range Step Size	seven steps, monotonic	2		5	dB
Frequency Deviation Min	PN Code Pattern 10101010		270		kHz
Frequency Deviation Max	PN Code Pattern 11110000		323		kHz
Error Vector Magnitude (FSK error)	>0 dBm		10		%rms
Occupied Bandwidth	-6 dBc, 100-kHz ResBW	500	876	1000	kHz



Table 5 – Radio Parameters (continued)

Parameter Description	Conditions	Min.	Typ.	Max.	Unit
<b>Transmit Spurious Emission (PA = 7)</b>					
In-band Spurious Second Channel Power ( $\pm 2$ MHz)			-38		dBm
In-band Spurious Third Channel Power ( $>3$ MHz)			-44		dBm
Non-Harmonically Related Spurs (800MHz)			-38		dBm
Non-Harmonically Related Spurs (1.6GHz)			-34		dBm
Non-Harmonically Related Spurs (3.2GHz)			-47		dBm
Harmonic Spurs (Second Harmonic)			-43		dBm
Harmonic Spurs (Third Harmonic)			-48		dBm
Fourth and Greater Harmonics			-59		dBm
<b>Power Management (with 30ppm crystal)</b>					
Crystal start to 10ppm			0.7	1.3	ms
Crystal start to IRQ	XSIRQ EN = 1		0.6		ms
Synth Settle	Slow channels			270	$\mu$ s
Synth Settle	Medium channels			180	$\mu$ s
Synth Settle	Fast channels			100	$\mu$ s
Link turn-around time	GFSK			30	$\mu$ s
Link turn-around time	250 kbps			62	$\mu$ s
Link turn-around time	125 kbps			94	$\mu$ s
Link turn-around time	<125 kbps			31	$\mu$ s
Max. packet length	<60ppm crystal-to-crystal all modes except 64-DDR			40	bytes
Max. packet length	<60ppm crystal-to-crystal 64-DDR			16	bytes

## 14 RF Regulatory Requirements

To satisfy FCC RF exposure requirements for mobile transmitting devices, a separation distance of 20 cm or more should be maintained between the antenna of this device and persons during device operation. To ensure compliance, operations at closer than this distance is not recommended.

The suggested antenna is an external 1/2 dipole or Centurion's Nano Blue PCB type, and it has been qualified and approved for use under the Modular Approval certification. This antenna is designed to be compatible with the RF impedance and frequency range of the AWA24S.

The suggested antenna has been specifically tested with the AWA24S, and has been certified through the regulatory agencies in the US, Canada, and European Union for authorized use. Use of an altered antenna in the AWA24S voids the MA grant for the AWA24S. Changes or modifications not expressly approved by the party responsible for compliance could void the user's authority to operate the equipment.

- Note:**
- 1- The AWA24S module is certified to work between Chanel 5 to 65 for North American applications. It is user's responsibility to not setup channels out side this range in its Firmware.
  - 2- For EU the module also has ETSI compliance for all 80 channels. Maximum power level allowed for EU operation is up to PA3 in CyFi resistor (10mW).
  - 3-The manufacturer is not responsible for any radio or TV interference caused by unauthorized modifications to this equipment. Such modifications could void the user's authority to operate the equipment.

For more details on the proper installation requirements please review Artaflex User Manual "UMAWA24S".

15 Pin Description

Table 6 - Connector Pin Information

Pin	Name	Type	Default	Description
1	GND	Power	GND	Ground
2	VCC	Power	VCC	Main Supply 2.4 to 3.6 volts
3	IRQ	I/O	-	Interrupt output (configurable active high or low), or GPIO
4	RST	Input	Input	Module Reset. Internal on Chip 10k-ohm pull-down resistor. Active HIGH
5	MOSI	I/O	Input	SPI data input, or SDAT
6	$\overline{SS}$	Input	Pull Up	SPI Interface enable, Active LOW
7	SCK	Input	Input	SPI Clock
8	MISO	I/O	Hi Z	SPI data output pin or GPIO in 3-pin SPI mode.
9	GND	Power	GND	Ground
10	*PACTL	Power	VCC	Power Control – max power at 3.3V - Shut down “0V”
11	TXPA	Input	Input	Active High to set Module into a Transmit mode (RXPA = Low)
12	RXPA	Input	Input	Active High to set the Module into a Receive mode (TXPA = Low)

\* Pin 10 will require a high current drive as it can sink up to 16mA of current when biased above 2V

16 Reference Documentation

Technical information such as register settings, timing, application interfaces, clocking, and power management for the Cypress Semiconductor CYRF7936WirelessUSB™ CYFI 2.4-GHz DSSS Radio System-on-Chip and the CY7C64215 enCoRe™ Full Speed USB Controller are available at [www.cypress.com](http://www.cypress.com)

The datasheet for CYRF7936 is available at:

[http://download.cypress.com.edgesuite.net/design\\_resources/datasheets/contents/cyrf7936\\_8.pdf](http://download.cypress.com.edgesuite.net/design_resources/datasheets/contents/cyrf7936_8.pdf)

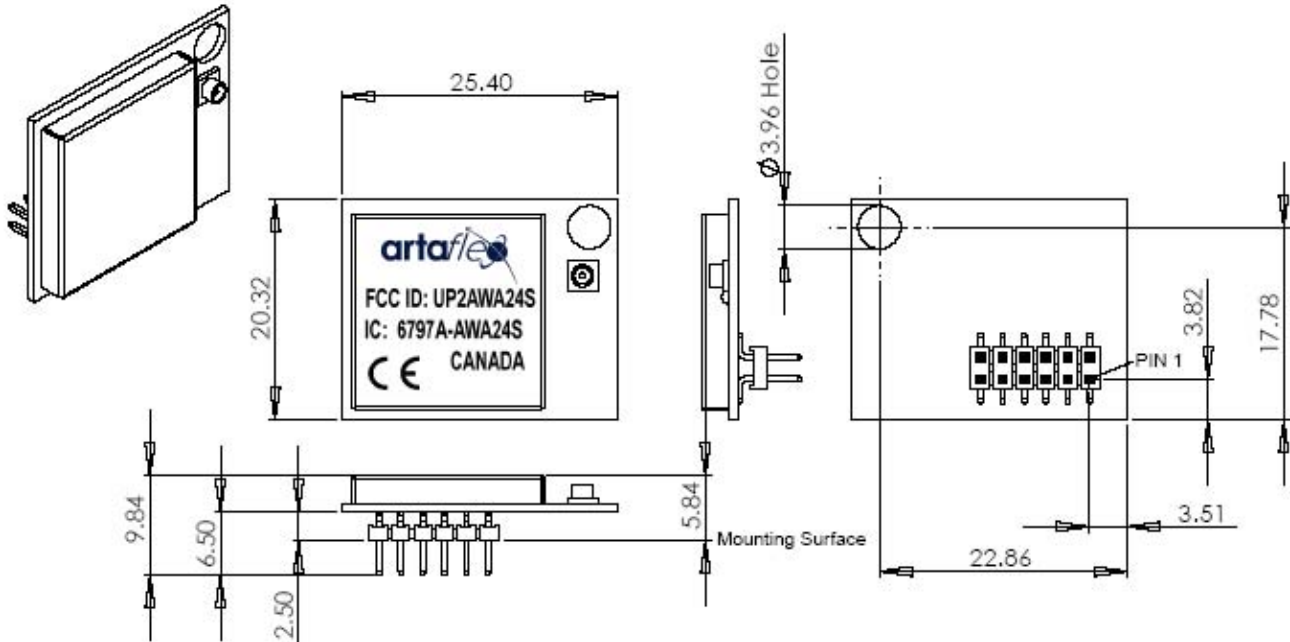

18.1 Standard Part Numbers

**Table 7 – Standard Part Numbers**

<b>Part Number</b>	<b>Description</b>	<b>Temperature</b>
AWA24S-12H2-C	2.4GHz DSSS PA Radio with 12 Pin Header in Commercial Temperature	0 to 70°C
AWA24S-12S2-C	2.4GHz DSSS PA Radio with 12 Pin Socket in Commercial Temperature	0 to 70°C

The information contained herein is subject to change without notice and may be found to contain errors of omission or changes in parameters. For feedback or technical support regarding Artaflex WirelessUSB Radio Modem products please contact Artaflex at [www.artaflex.com](http://www.artaflex.com).

Artaflex Inc. assumes no responsibility for the use of any circuitry other than circuitry embodied in an Artaflex product.

Nor does it convey or imply any license under patent or other rights. Artaflex products are not warranted nor intended to be used for medical, life support, life saving, critical control or safety applications, unless pursuant to an express written agreement with Artaflex Inc. Furthermore, Artaflex does not authorize its products for use as critical components in life-support systems where a malfunction or failure may reasonably be expected to result in significant injury to the user. The inclusion of Artaflex products in life-support systems application implies that the manufacturer assumes all risk of such use and in doing so indemnifies Artaflex Inc. against all charges.

WirelessUSB and AutoRate are trademarks™ of Cypress Semiconductor.

All products and company names mentioned in this document are the trademarks of their respective holders.