

Ratings

Voltage: 300 V
 Operating temperature: -20° to 80 °C

Conductor

Gauge: 18 AWG, 0.82 mm²
 Material: tinned copper strands
 Strand size: Ø 0.16 mm
 Strand count: 41
 Max resistance at 20 °C: 23.2 Ω/km

Insulator

Material: PVC
 Color: white
 Outer diameter: 2.05 ±0.10 mm
 Min resistance at 20 °C: 10 MΩ/km

Shield

Type: spiral
 Material: tinned copper strands
 Strand size: Ø 0.16 mm
 Strand count: 41 ±2

Outer jacket

Material: TPU, 80 °C
 Type: extruded, non-integral
 Color: black
 Diameter: 4.0 ±0.20 mm

Wire marking: E339579 AWM STYLE 10846 80°C
 300V VW-1 --- C AWM I/II A 80°C 300V FT1 TENSILITY

Tests

Voltage test: 300 V
 Spark test: 3.0 kV
 Tensile strength: 1.05 kgf/mm²
 After aging at 113 ±2 °C for 7 days:
 Minimum tensile strength 70 % original
 Minimum elongation 65 % original
 Heat shock: 121 ±1 °C /1 hour, no observed degradation
 Deformation: 121 ±1 °C /1 hour, ≤ 50 %
 Cold bend: -10 ±1 °C /1 hour, no observed cracking
 Flammability: FT1, VW-1
 Dielectric test: 1500 V ac for 1 minute without breakdown

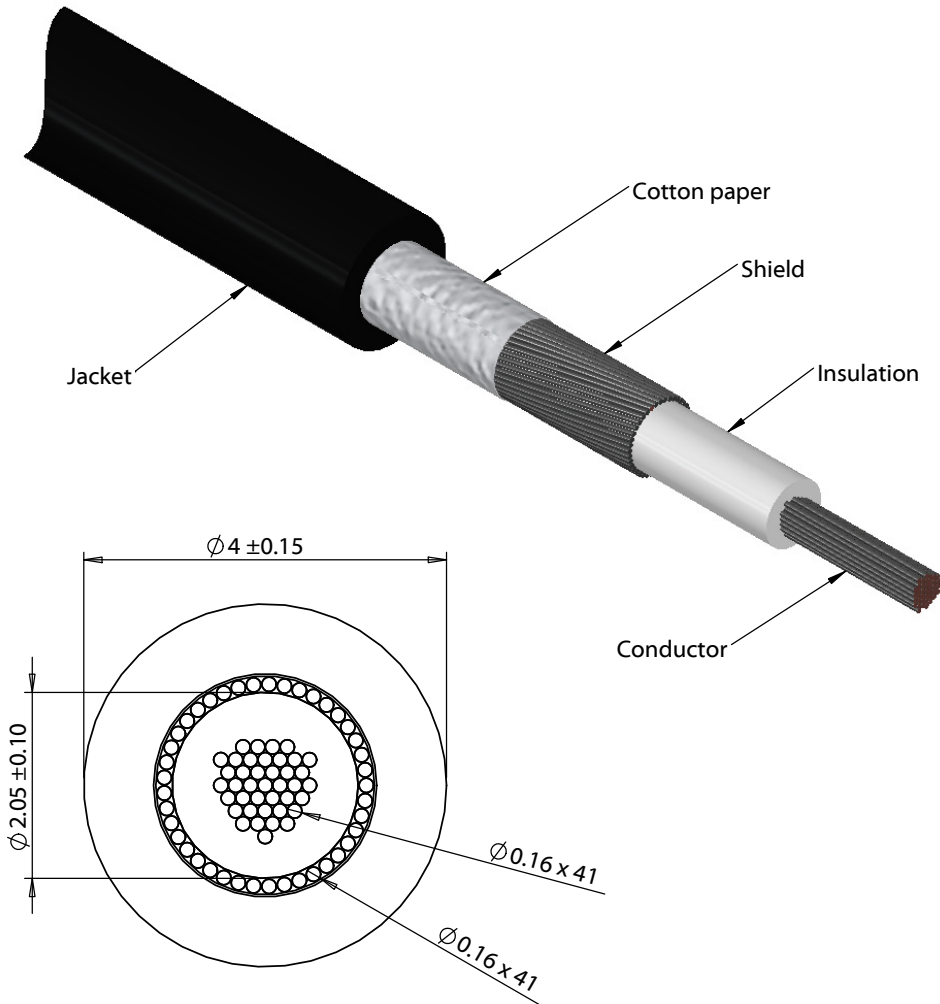

REVISION	DATE	DESCRIPTION
A	9/2/2015	Initial release
A1	9/14/2015	Upgraded fire rating to VW-1/ FT1
A2	3/10/2016	Updated operating temperature range

PREPARED:

 VERIFIED:

 DIMENSIONS ARE IN MILLIMETERS
 TOLERANCES:
 X: ± 0.5 mm
 X.X: ± 0.3 mm
 X.XX: ± 0.05 mm

NOTES
 RoHS and REACH compliant
 Function test: no open, no short circuit, no intermittent
 Drawing in third angle projected
 DESCRIPTION:
 Wire, 1C TS, 18 AWG, UL10846, 300V, 80C, 4.0 mm, shielded, VW-1, TPU

TENSILITY
 20802 Sockeye Place #130
 Bend, OR 97701 USA
 tel 541.323.3228 fax 541.323.4202
 800 877.670.7118 www.tensility.com

SIZE A	PART NUMBER 30-00558
SCALE: 12:1	SHEET 1 OF 1