

NBC-06-472

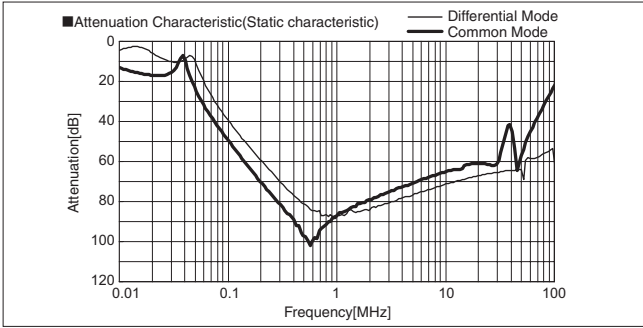

NBM-06-471

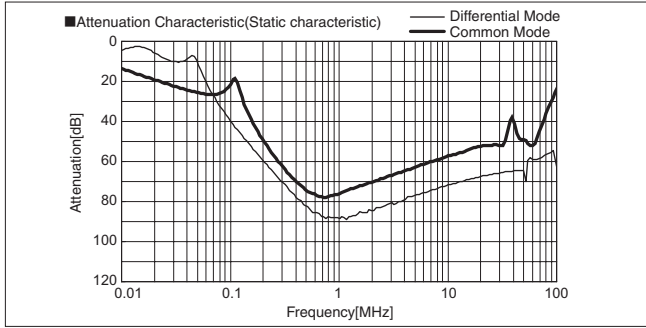

NBC-10-472

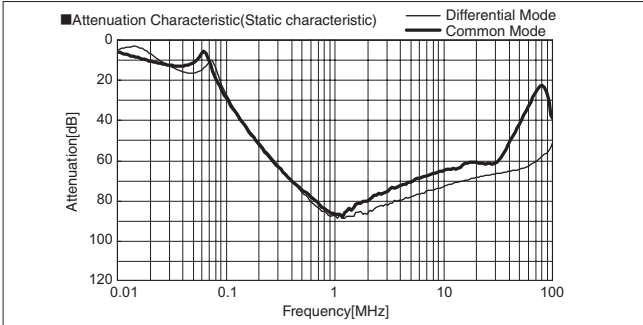

NBM-10-471

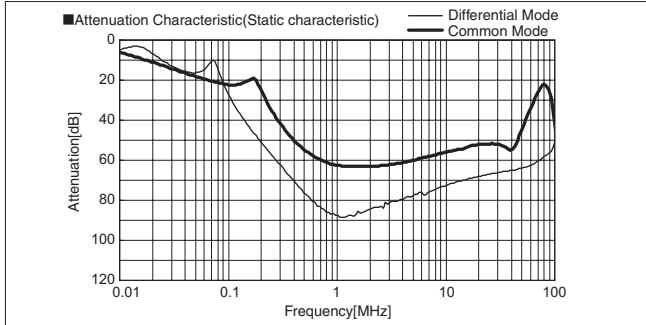

NBC-16-472

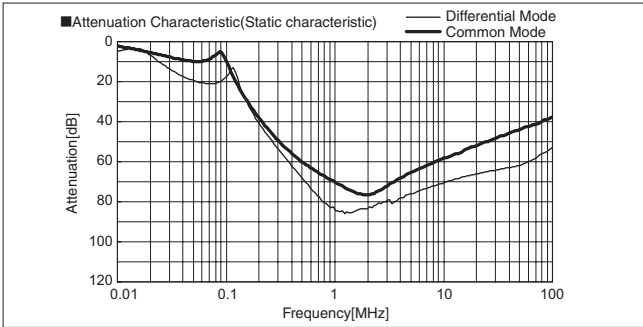

NBM-16-471

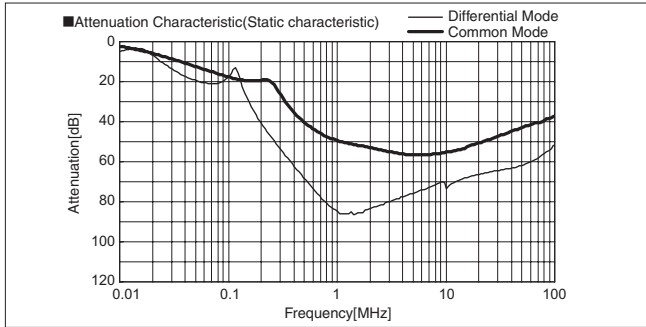

NBC-20-472

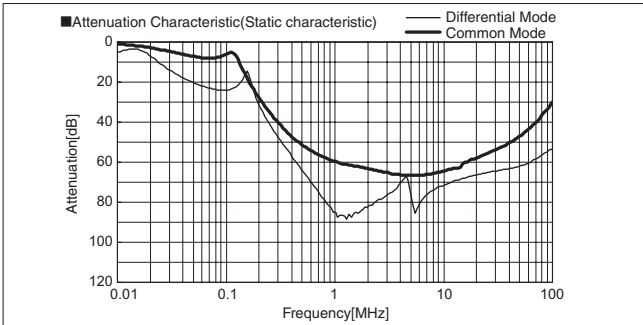

NBM-20-471

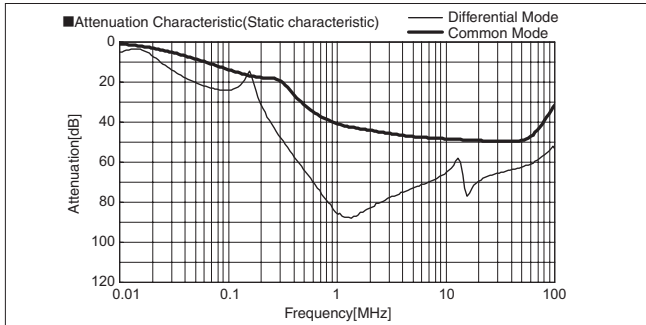

NBC-30-472

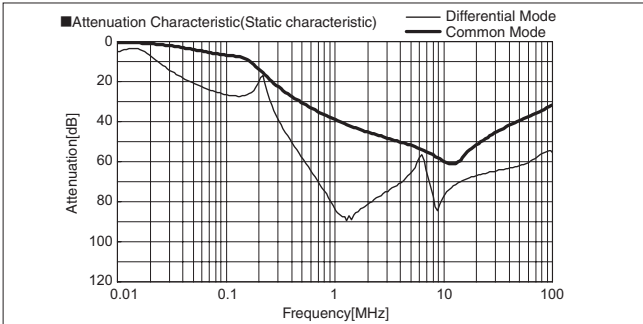

NBM-30-471

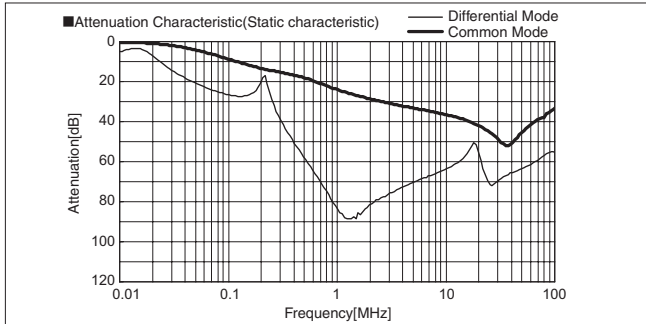

1 Method of connecting EMI/EMC Filter

(1) Single Phase

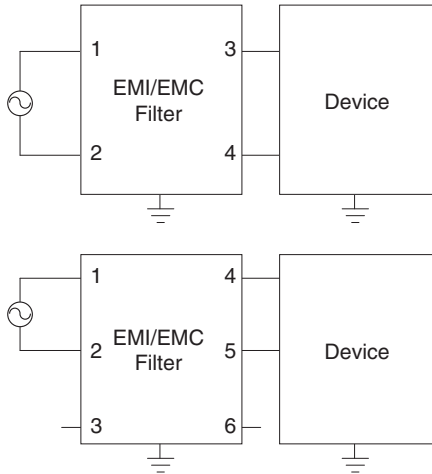

※Three phase EMI/EMC filter is also available as a single phase input type.

(2) Three phase (Delta-connection)

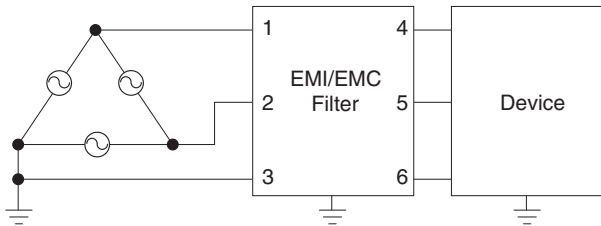

(3) Three phase (Star-connection)

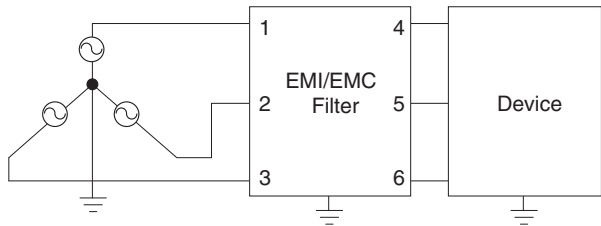

[Reference] Example of calculating input current calculation

Input voltage 400 [V]

Input capacity of the equipment 4000 [VA]

$$\text{Input current} = \frac{4000 \text{ [VA]}}{400 \text{ [V]} \times \sqrt{3}} = 5.8 \text{ [A]}$$

2 Caution when connecting EMI/EMC Filter

Please note the excessive temperature increase of EMI/EMC filter. Please contact us if judgement is difficult.

(1) Input voltage and frequency

Please use within the rated voltage (or maximum voltage) of each model.

Input frequency specification for AC input EMI/EMC filter is considered as commercial frequency (50/60Hz).

It should not be used under the following conditions.

- 1) Distorted input voltage waveform.
(Triangle wave, square wave etc.)
- 2) High input frequency (ex: 400Hz)

(2) Input current

Please use within the rated current of each model.

EMI/EMC filters have short term peak current capability. Therefore, it can flow ~40A or ten times of rated current, non-repeated, within a few ms such as inrush current of power supply etc.

However, it should not be used under the following conditions.

- 1) Long duration peak current.
- 2) Peak current or high-frequency current is continuously flowing.

(3) Connection to a general-purpose inverter (servo driver)

Please connect EMI/EMC filter to input side of inverter driver (servo driver).

It should not be used between the inverter (servo driver) and the motor.

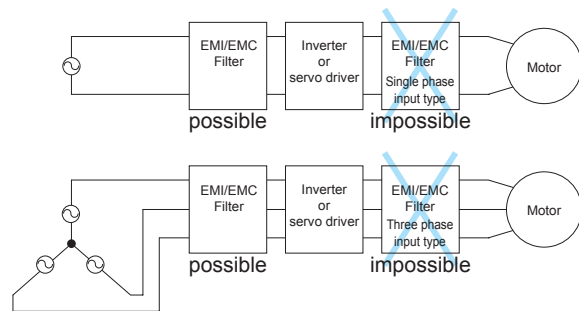

3 Safety Considerations

- To apply for safety standard approval using this EMI/EMC Filter, the following conditions must be met.
- The unit must be used as a component of an end-use equipment.
- Protection earth terminal (PE) must be connected to safety ground of end-use equipment.

1 Noise Transmission

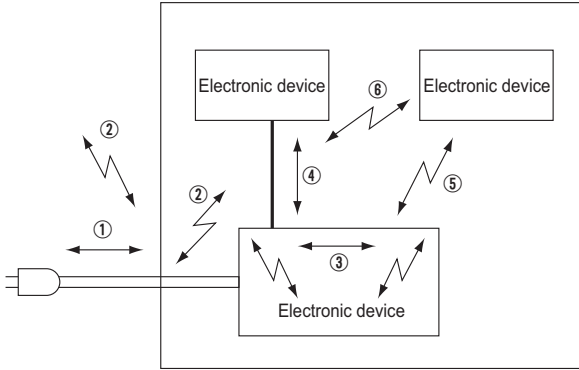

Noise transmission between electric power and electronic device

- ① Conducted noise from electric power lines.
- ② Radiated noise which is picked up and generated by the power line as antenna.
- ③ Conducted and radiated noise which is generated in the electronic device.
- ④ Conducted noise which is generated by the signal lines between electronic devices.
- ⑤ Radiated noise emitted an electronic device that interferes with other device.
- ⑥ Radiated noise which is picked up and generated by the signal line as antenna.

2 Application Precautions

The following points should be kept in mind to use the EMI/EMC Filter more effectively.

■ Input wire and output wire of the EMI/EMC Filter should be separated.

When the input/output wire are bundled together or wired parallel with each other, high frequency noise is induced so, and the expected effect of noise attenuation cannot be achieved.

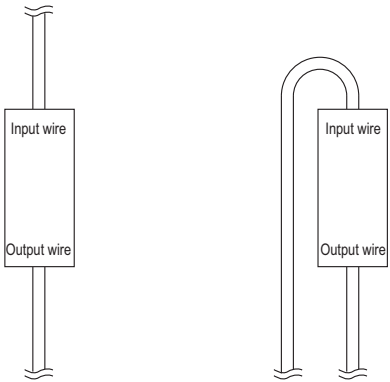

Good wiring example

Bad wiring example

■ Ground lines should be as short as possible. If it is not, an equivalent inductance appears, and the high frequency attenuation characteristics degrade. When grounding the mounting plate of the EMI/EMC Filter, you should remove the paint to reduce the contact resistance from the equipment case, and then install the EMI/EMC Filter.

3 Method of measuring characteristic data

※ Attenuation = $20\log(U_{01}/U_{02})$ [dB]
 U_{01} : Voltage in state without filters
 U_{02} : Voltage in state which added filters
 ※ N.A. : Network analyzer

(1) Attenuation Characteristic(Static characteristic)

Object product: Single phase input type

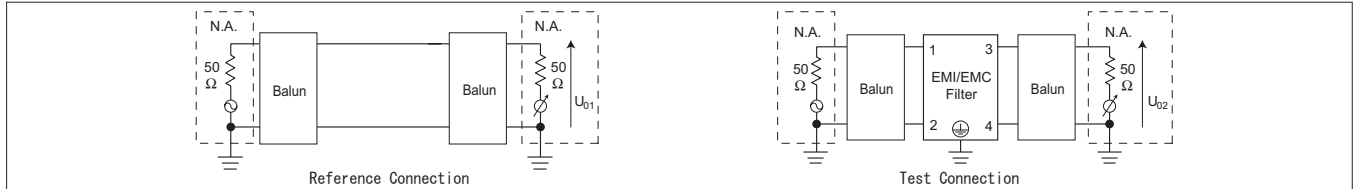

Fig.3.1 Differential mode attenuation measurement diagram

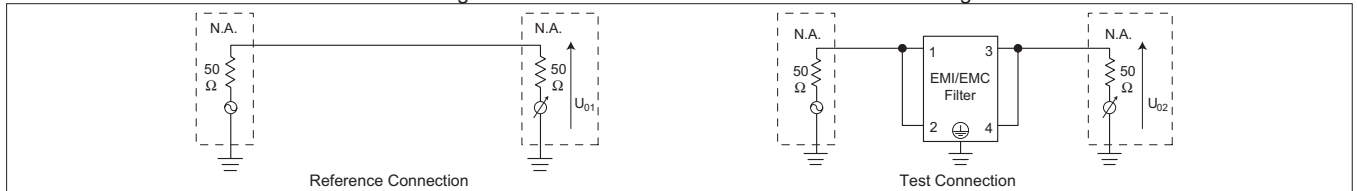

Fig.3.2 Common mode attenuation measurement diagram

Object product: Three phase input type

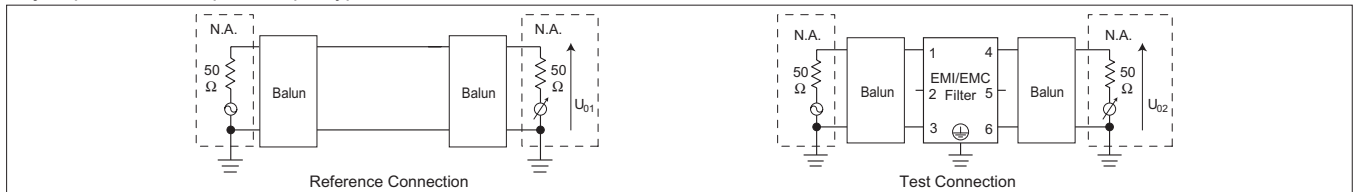

Fig.3.3 Differential mode attenuation measurement diagram

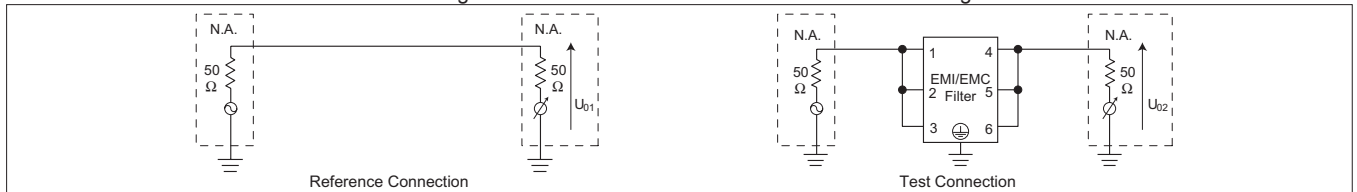

Fig.3.4 Common mode attenuation measurement diagram

Object product: DC input type

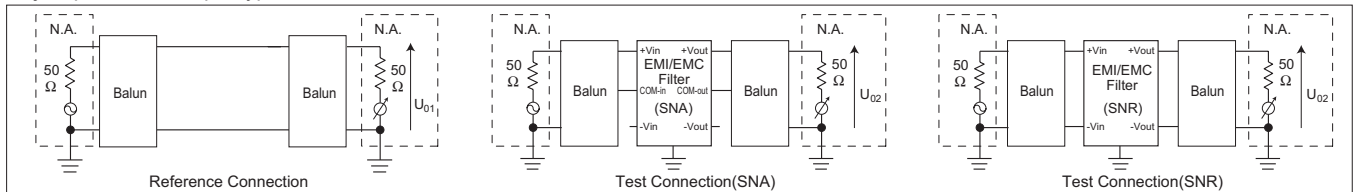

Fig.3.5 Differential mode attenuation measurement diagram

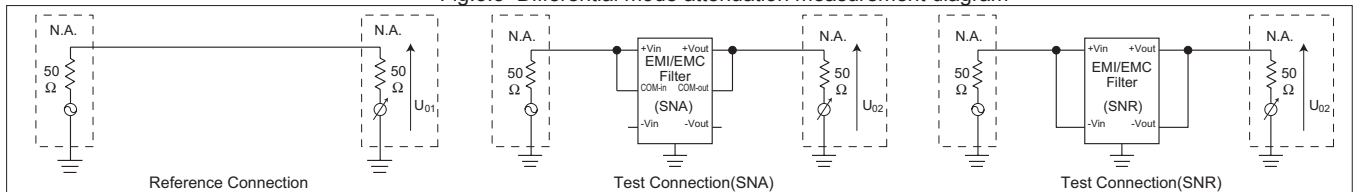

Fig.3.6 Common mode attenuation measurement diagram

(2) Pulse Attenuation Characteristic

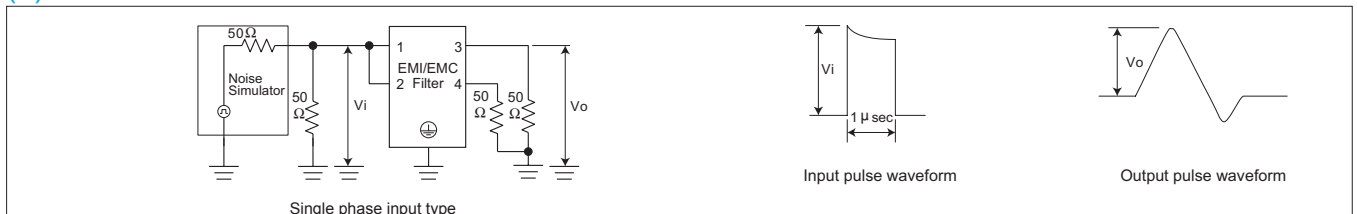

Fig.3.7 Pulse attenuation measurement diagram