

10A, 400V - 800V Glass Passivated Bridge Rectifiers

FEATURES

- Glass passivated junction
- Ideal for printed circuit board
- Typical IR less than 0.1μA
- High surge current capability
- UL Recognized File # E-326243
- Compliant to RoHS Directive 2011/65/EU and in accordance to WEEE 2002/96/EC
- Halogen-free according to IEC 61249-2-21

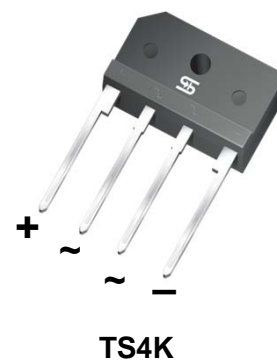

MECHANICAL DATA

Case: TS4K

Molding compound, UL flammability classification rating 94V-0

Part no. with suffix "H" means AEC-Q101 qualified

Packing code with suffix "G" means green compound (halogen-free)

Terminal: Matte tin plated leads, solderable per JESD22-B102

Meet JESD 201 class 2 whisker test

Polarity: Polarity as marked on the body

Mounting torque: 8.17 in-lbs maximum

Weight: 4 g (approximately)

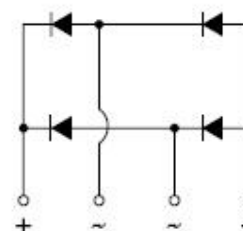

MAXIMUM RATINGS AND ELECTRICAL CHARACTERISTICS (T _A =25°C unless otherwise noted)					
PARAMETER	SYMBOL	TS10K40	TS10K60	TS10K80	UNIT
Maximum repetitive peak reverse voltage	V _{RRM}	400	600	800	V
Maximum RMS voltage	V _{RMS}	280	420	560	V
Maximum DC blocking voltage	V _{DC}	400	600	800	V
Maximum average forward rectified current	I _{F(AV)}	10			A
Peak forward surge current, 8.3 ms single half sine-wave superimposed on rated load	I _{FSM}	150			A
Rating for fusing (t<8.3ms)	I ² t	93			A ² s
Maximum instantaneous forward voltage I _F =5A (Note 1)	V _F	1.0			V
I _F =10A		1.1			
Maximum reverse current @ rated V _R	I _R	10			μA
T _J =25°C		500			
T _J =125°C					
Typical thermal resistance	R _{θJC}	2.3			°C/W
Operating junction temperature range	T _J	- 55 to +150			°C
Storage temperature range	T _{STG}	- 55 to +150			°C

Note 1: Pulse test with PW=300μs, 1% duty cycle

ORDERING INFORMATION

PART NO.	PART NO. SUFFIX	PACKING CODE	PACKING CODE SUFFIX (*)	PACKAGE	PACKING
TS10Kxx (Note 1)	H	D3	G	TS4K	20 / TUBE
		X0		TS4K	Forming

Note 1: "xx" defines voltage from 400V (TS10K40) to 800V (TS10K80)

*: Optional available

EXAMPLE

PREFERRED P/N	PART NO.	PART NO. SUFFIX	PACKING CODE	PACKING CODE SUFFIX	DESCRIPTION
TS10K80HD3G	TS10K80	H	D3	G	AEC-Q101 qualified Green compound

RATINGS AND CHARACTERISTICS CURVES

(T_A=25°C unless otherwise noted)

FIG.1 FORWARD CURRENT DERATING CURVE

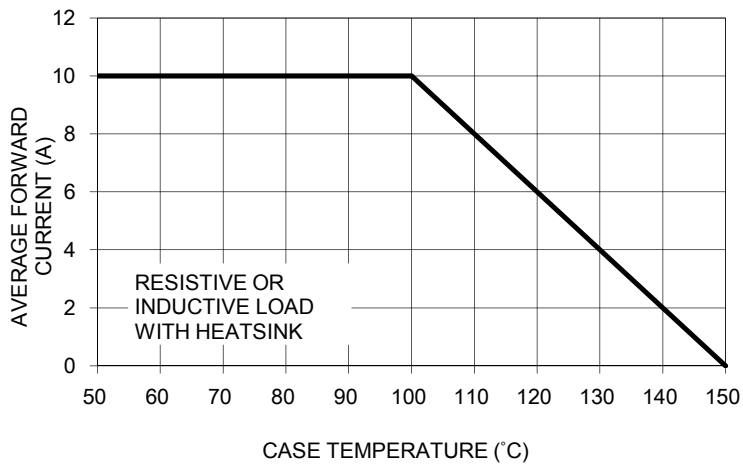

FIG. 2 TYPICAL REVERSE CHARACTERISTICS

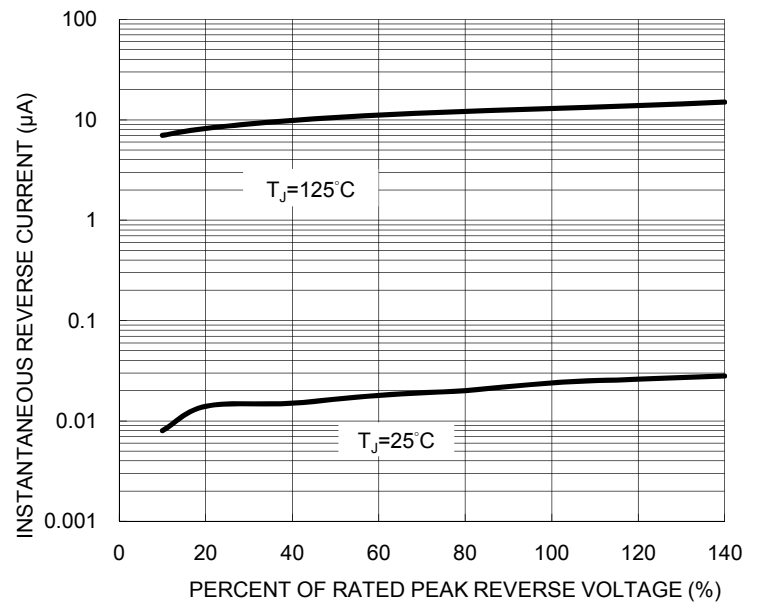

FIG. 3 MAXIMUM NON-REPETITIVE FORWARD SURGE CURRENT

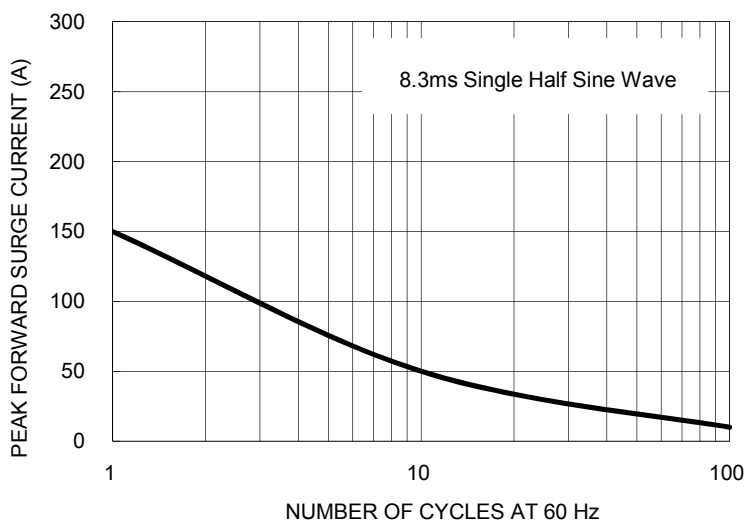

FIG. 4 TYPICAL FORWARD CHARACTERISTICS

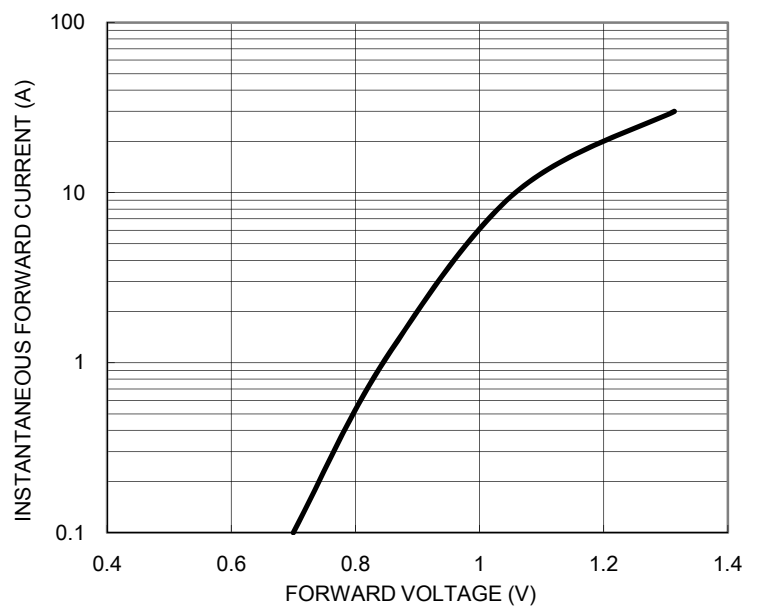
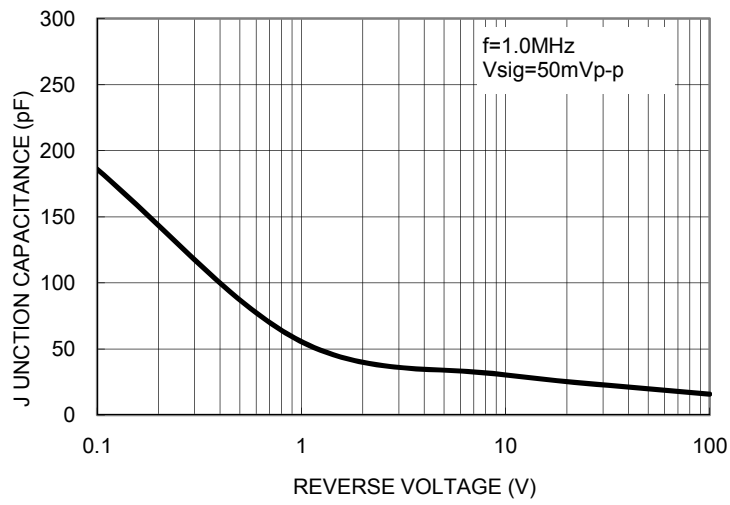
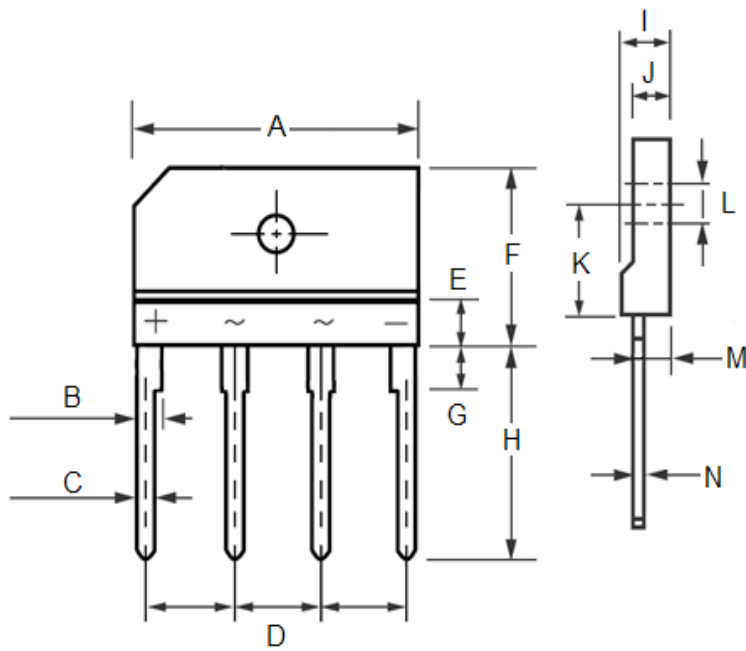

FIG. 5 TYPICAL JUNCTION CAPACITANCE



PACKAGE OUTLINE DIMENSIONS

TS4K



DIM.	Unit (mm)		Unit (inch)	
	Min	Max	Min	Max
A	24.70	25.30	0.972	0.996
B	2.00	2.30	0.079	0.091
C	0.90	1.10	0.035	0.043
D	7.30	7.70	0.287	0.303
E	3.00	5.00	0.118	0.197
F	14.70	15.30	0.579	0.602
G	3.30	3.70	0.130	0.146
H	17.00	18.00	0.669	0.709
I	4.40	4.80	0.173	0.189
J	3.40	3.80	0.134	0.150
K	9.30	9.60	0.366	0.378
L	3.10	3.60	0.122	0.142
M	3.10	3.40	0.122	0.134
N	0.50	0.70	0.020	0.028

MARKING DIAGRAM



- P/N = Specific Device Code
- G = Green Compound
- YWW = Date Code
- F = Factory Code

Notice

Specifications of the products displayed herein are subject to change without notice. TSC or anyone on its behalf, assumes no responsibility or liability for any errors or inaccuracies.

Information contained herein is intended to provide a product description only. No license, express or implied, to any intellectual property rights is granted by this document. Except as provided in TSC's terms and conditions of sale for such products, TSC assumes no liability whatsoever, and disclaims any express or implied warranty, relating to sale and/or use of TSC products including liability or warranties relating to fitness for a particular purpose, merchantability, or infringement of any patent, copyright, or other intellectual property right.

The products shown herein are not designed for use in medical, life-saving, or life-sustaining applications. Customers using or selling these products for use in such applications do so at their own risk and agree to fully indemnify TSC for any damages resulting from such improper use or sale.