

## LOW SATURATION DUAL OPERATIONAL AMPLIFIER

### ■ GENERAL DESCRIPTION

The NJM2140 is a low saturation output voltage dual operational amplifier in small packages. It features a low voltage operation of  $\pm 1.0V$  (min.) and low saturation output voltage of  $\pm 2.0V_{p-p}$  (at supply voltage  $\pm 2.5V$ ). The NJM2140 is available in both 8-lead MSOP and thin type MSOP packages.

### ■ FEATURES

- Operating Voltage  $\pm 1V$  to  $\pm 7V$
- High Slew Rate  $4V/\mu s$  typ.
- Wide Band  $12MHz$  typ.
- Low Saturation Output Voltage  $\pm 2.4V$  typ. (at  $V^+V^- = \pm 2.5V, R_L = 10k\Omega$ )
- Package Outline MSOP8 (VSP8) MEET JEDEC MO-187-DA  
MSOP8 (TVSP8) MEET JEDEC MO-187-DA / THIN TYPE
- Bipolar Technology

### ■ PACKAGE OUTLINE



**NJM2140R**  
(MSOP8 (VSP8))



**NJM2140RB1**  
(MSOP8 (TVSP8))

### ■ PIN CONFIGURATION

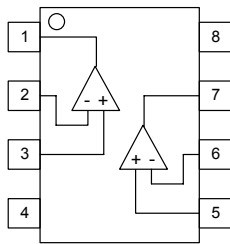

- PIN FUNCTION**
- 1.A OUTPUT
  - 2.A -INPUT
  - 3.A +INPUT
  - 4.V<sup>-</sup>
  - 5.B +INPUT
  - 6.B -INPUT
  - 7.B OUTPUT
  - 8.V<sup>+</sup>

**NJM2140R/RB1**

### ■ EQUIVALENT CIRCUIT

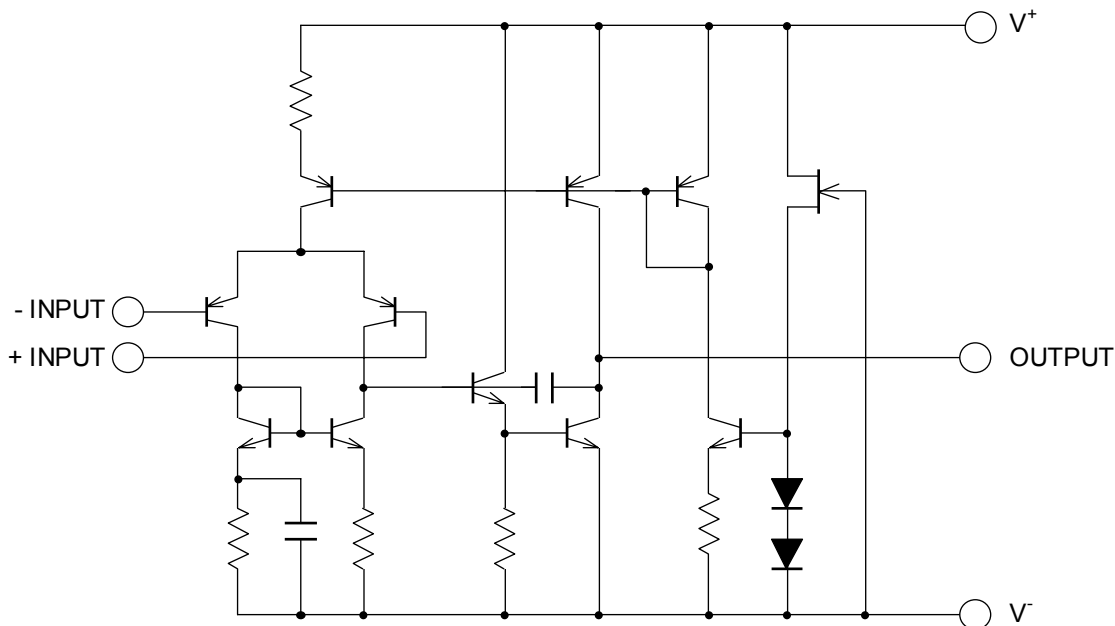

# NJM2140

## ■ ABSOLUTE MAXIMUM RATINGS

(Ta=25°C)

PARAMETER	SYMBOL	RATINGS	UNIT
Supply Voltage	V <sup>+</sup> /V	± 7.0	V
Differential Input Voltage	V <sub>ID</sub>	± 14	V
Power Dissipation	P <sub>D</sub>	(MSOP8(VSP/TVSP8)) 320	mW
Operating Temperature Range	T <sub>opr</sub>	-40~+85	°C
Storage Temperature Range	T <sub>stg</sub>	-40~+125	°C

## ■ ELECTRICAL CHARACTERISTICS

(V<sup>+</sup>/V<sup>-</sup>=±2.5V, Ta=25°C)

PARAMETER	SYMBOL	TEST CONDITION	MIN.	TYP.	MAX.	UNIT
Input Offset Voltage	V <sub>IO</sub>	R <sub>S</sub> ≤10kΩ	-	1	6	mV
Input Offset Current	I <sub>IO</sub>		-	10	200	nA
Input Bias Current	I <sub>B</sub>		-	100	300	nA
Large Signal Voltage Gain	A <sub>V</sub>	R <sub>L</sub> ≥10kΩ	60	80	-	dB
Maximum Output Voltage Swings 1	V <sub>OM1</sub>	R <sub>L</sub> =2.5kΩ	± 2.0	± 2.2	-	V
Maximum Output Voltage Swings 2	V <sub>OM2</sub>	R <sub>L</sub> ≥10kΩ	± 2.3	± 2.4	-	V
Input Common Mode Voltage Range	V <sub>ICM</sub>		± 1.5	-	-	V
Common Mode Rejection Ratio	CMRR		60	74	-	dB
Supply Voltage Rejection Ratio	PSRR		60	80	-	dB
Operating Current	I <sub>CC</sub>		-	3.5	5	mA
Slew Rate	SR		-	4	-	V/μs
Unity Gain Frequency	f <sub>T</sub>		-	12	-	MHz

## ■ TYPICAL CHARACTERISTICS

Maximum Peak-to-peak Output Voltage Swing vs. Frequency  
( $V^+/V^- = \pm 2.5V, R_L = 2.5k\Omega, T_a = 25^\circ C$ )

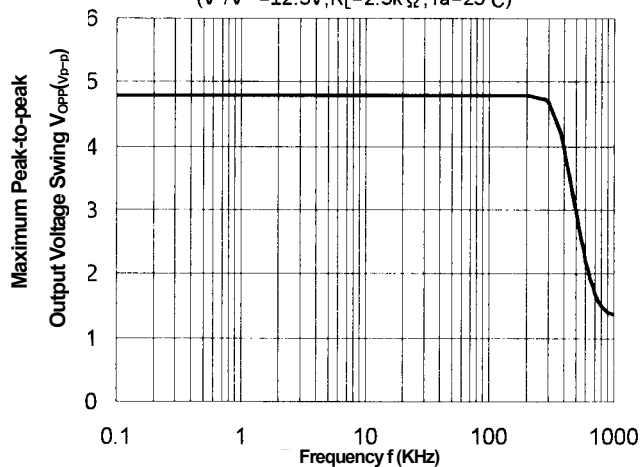

Equivalent Input Noise Voltage vs. Source Resistance  
( $V^+/V^- = \pm 2.5V, T_a = 25^\circ C$ )

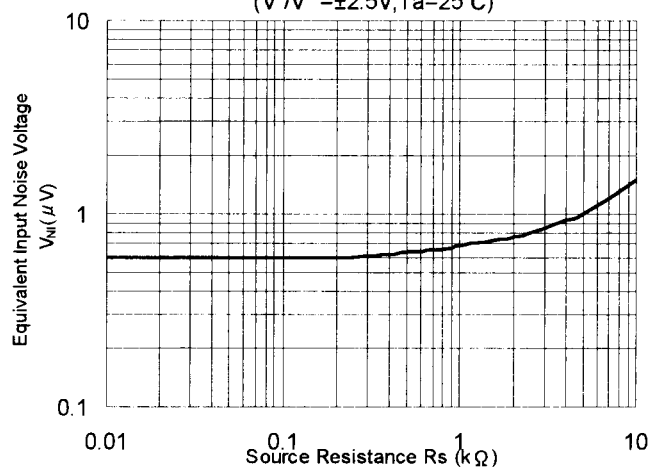

Operating Current vs. Temperature  
( $V^+/V^- = \pm 2.5V$ )

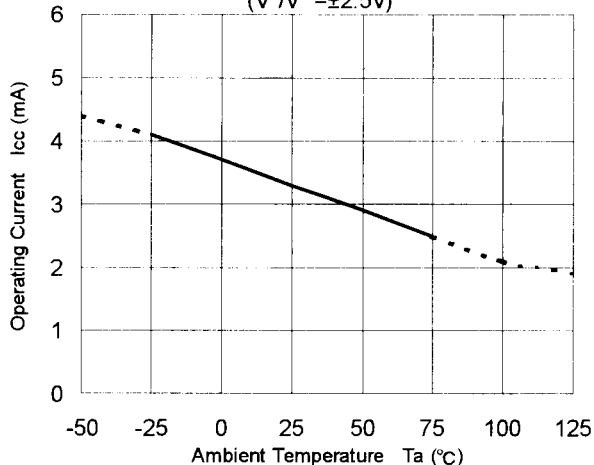

Input Offset Voltage vs. Temperature  
( $V^+/V^- = \pm 2.5V, R_s = 10k\Omega$ )

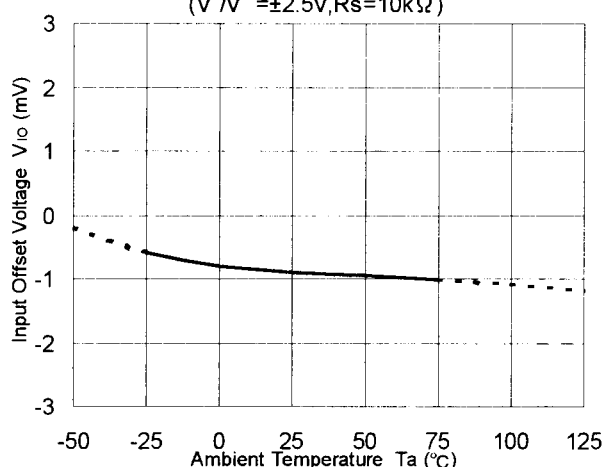

Input Bias Current vs. Temperature  
( $V^+/V^- = \pm 2.5V, R_L = 2.5k\Omega$ )

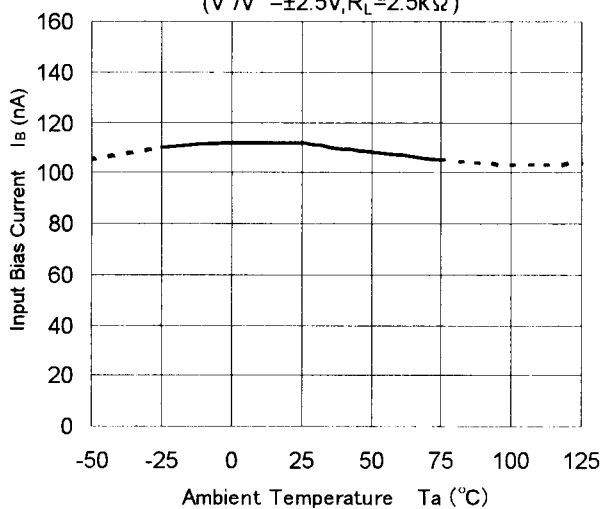

Output Voltage Swing vs. Temperature  
( $V^+/V^- = 2.5V, R_L = 2.5k\Omega$ )

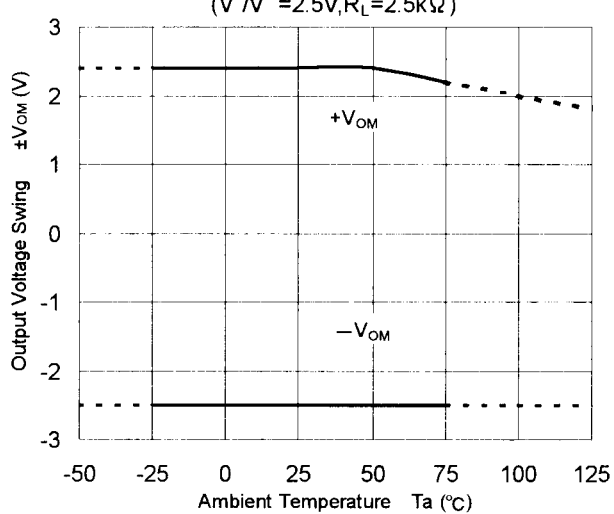

## ■ TYPICAL CHARACTERISTICS

Maximum Output Voltage Swing vs. Operating Voltage  
( $R_L=2.5k\Omega, T_a=25^\circ C$ )

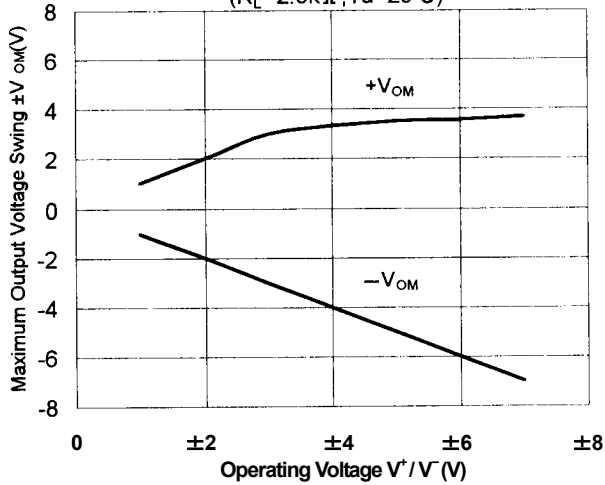

Operating Current vs. Operating Voltage  
( $T_a=25^\circ C$ )

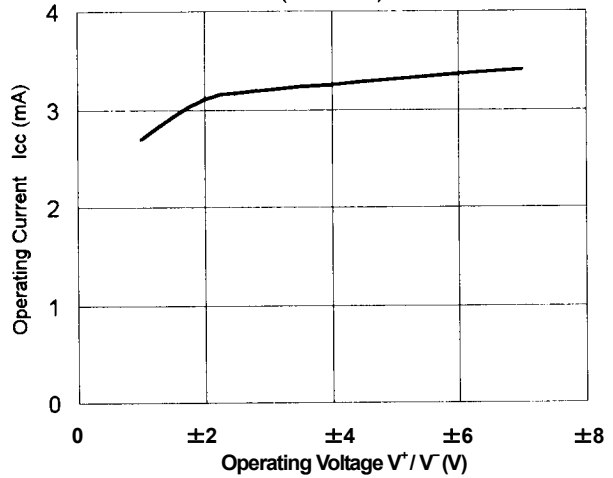

Maximum Output Voltage Swing vs. Load Resistance  
( $V^+/V^-=\pm 2.5V, T_a=25^\circ C$ )

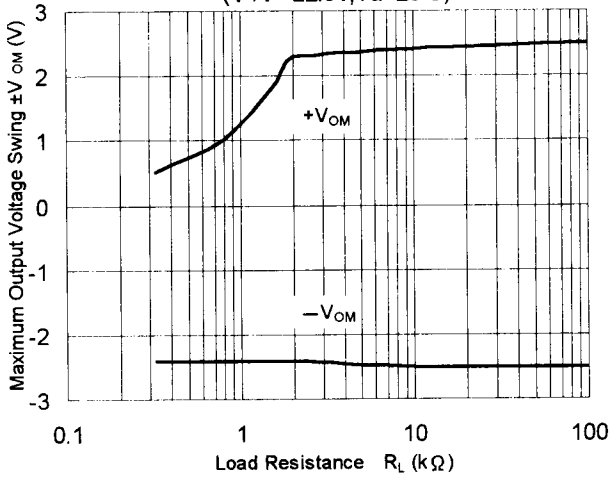

Input Bias Current vs. Operating Voltage  
( $T_a=25^\circ C$ )

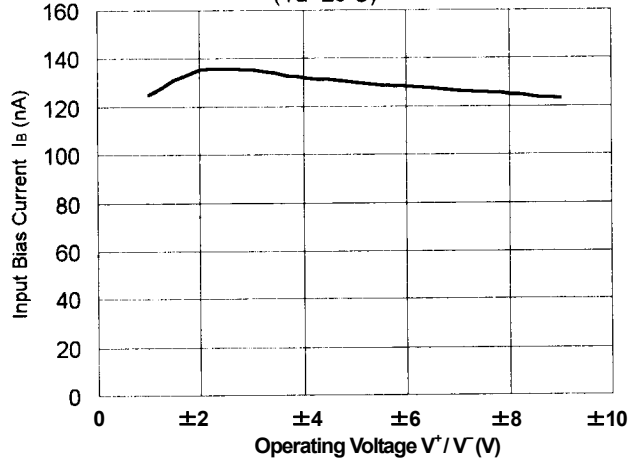

Input Offset Voltage vs. Operating Voltage  
( $T_a=25^\circ C, R_s=10k\Omega$ )

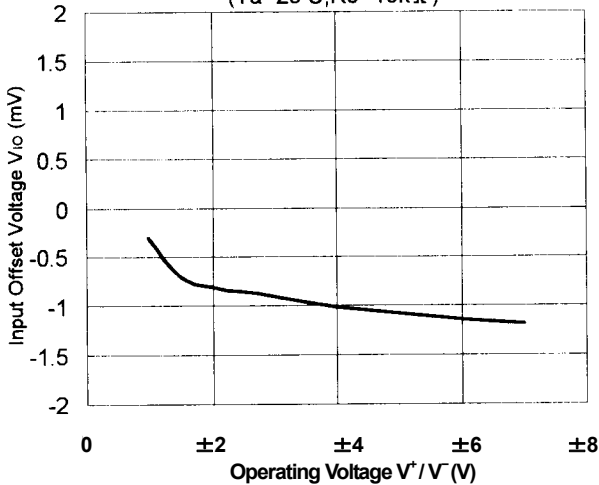

Total Harmonic Distortion vs. Output Voltage  
( $V^+/V^-=\pm 2.5V, R_L=2.5k\Omega, \text{Gain}=10\text{dB}$ )

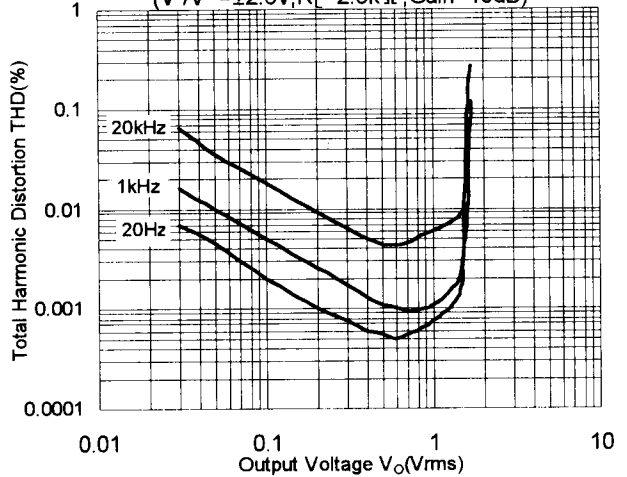

**[CAUTION]**  
The specifications on this databook are only given for information, without any guarantee as regards either mistakes or omissions. The application circuits in this databook are described only to show representative usages of the product and not intended for the guarantee or permission of any right including the industrial rights.