

1PMT5.0AT1G/T3G Series

Zener Transient Voltage Suppressor Littelfuse Package

The 1PMT5.0AT1G/T3G Series is designed to protect voltage sensitive components from high voltage, high energy transients. Excellent clamping capability, high surge capability, low Zener impedance and fast response time. The advanced packaging technique provides for a highly efficient micro miniature, space saving surface mount with its unique heatsink design. It has the same thermal performance as the SMA while being 50% smaller in footprint area, and delivering one of the lowest height profiles (1.1 mm) in the industry. Because of its small size, it is ideal for use in cellular phones, portable devices, business machines, power supplies and many other industrial/consumer applications.

Specification Features:

- Stand-off Voltage: 5.0 V – 58 V
- Peak Power – 200 W @ 1 ms (1PMT5.0A – 1PMT36A)
– 175 W @ 1 ms (1PMT40A – 1PMT58A)
- Maximum Clamp Voltage @ Peak Pulse Current
- Low Leakage
- Response Time is Typically < 1 ns
- ESD Rating of Class 3 (> 16 kV) per Human Body Model
- Low Profile – Maximum Height of 1.1 mm
- Integral Heatsink/Locking Tabs
- Full Metallic Bottom Eliminates Flux Entrapment
- Small Footprint – Footprint Area of 8.45 mm²
- Lead Orientation in Tape: Cathode (Short) Lead to Sprocket Holes
- Cathode Indicated by Polarity Band
- These Devices are Pb-Free and are RoHS Compliant

Mechanical Characteristics:

CASE: Void-free, transfer-molded, thermosetting plastic

FINISH: All external surfaces are corrosion resistant and leads are readily solderable

MOUNTING POSITION: Any

MAXIMUM CASE TEMPERATURE FOR SOLDERING PURPOSES:
260°C for 10 Seconds



Expertise Applied | Answers Delivered

Littelfuse.com

PLASTIC SURFACE MOUNT ZENER OVERVOLTAGE TRANSIENT SUPPRESSOR 5 – 58 V 200 W PEAK POWER

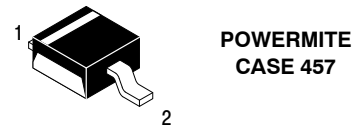
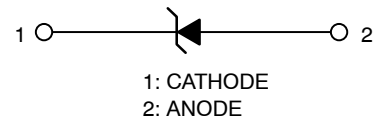

MARKING DIAGRAM

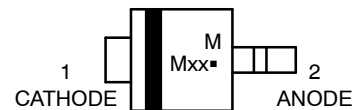

- M = Date Code
- Mxx = Specific Device Code
(See Table on Page 3)
- = Pb-Free Package

ORDERING INFORMATION

Device	Package	Shipping†
1PMTxxAT1G	POWERMITE (Pb-Free)	3,000/Tape & Reel
1PMTxxAT3G	POWERMITE (Pb-Free)	12,000/Tape & Reel

1PMT5.0AT1G/T3G Series

MAXIMUM RATINGS

Rating	Symbol	Value	Unit
Maximum P_{pk} Dissipation, (PW-10/1000 μ s) (Note 1) (1PMT5.0A – 1PMT36A)	P_{pk}	200	W
Maximum P_{pk} Dissipation, (PW-10/1000 μ s) (Note 1) (1PMT40A – 1PMT58A)	P_{pk}	175	W
Maximum P_{pk} Dissipation, (PW-8/20 μ s) (Note 1)	P_{pk}	1000	W
DC Power Dissipation @ $T_A = 25^\circ\text{C}$ (Note 2) Derate above 25°C	P_D	500	mW
Thermal Resistance, Junction-to-Ambient	$R_{\theta JA}$	4.0	$\text{mW}/^\circ\text{C}$
Thermal Resistance, Junction-to-Lead (Anode)	$R_{\theta J\text{anode}}$	248	$^\circ\text{C}/\text{W}$
Maximum DC Power Dissipation (Note 3) Thermal Resistance, Junction-to-Tab (Cathode)	P_D $R_{\theta J\text{cathode}}$	3.2 23	W $^\circ\text{C}/\text{W}$
Operating and Storage Temperature Range	T_J, T_{stg}	-55 to +150	$^\circ\text{C}$

Stresses exceeding Maximum Ratings may damage the device. Maximum Ratings are stress ratings only. Functional operation above the Recommended Operating Conditions is not implied. Extended exposure to stresses above the Recommended Operating Conditions may affect device reliability.

1. Nonrepetitive current pulse at $T_A = 25^\circ\text{C}$.
2. Mounted with recommended minimum pad size, DC board FR-4.
3. At Tab (Cathode) temperature, $T_{tab} = 75^\circ\text{C}$

ELECTRICAL CHARACTERISTICS ($T_A = 25^\circ\text{C}$ unless otherwise noted, $V_F = 3.5\text{ V Max. @ } I_F$ (Note 4) = 35 A)

Symbol	Parameter
I_{PP}	Maximum Reverse Peak Pulse Current
V_C	Clamping Voltage @ I_{PP}
V_{RWM}	Working Peak Reverse Voltage
I_R	Maximum Reverse Leakage Current @ V_{RWM}
V_{BR}	Breakdown Voltage @ I_T
I_T	Test Current
I_F	Forward Current
V_F	Forward Voltage @ I_F

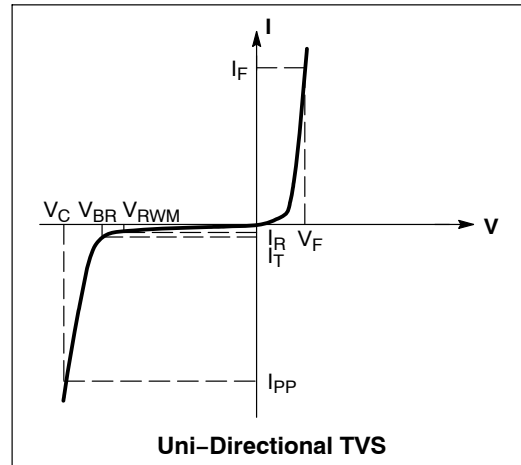

1PMT5.0AT1G/T3G Series

ELECTRICAL CHARACTERISTICS ($T_L = 30^\circ\text{C}$ unless otherwise noted, $V_F = 1.25$ Volts @ 200 mA)

Device*	Marking	V_{RWM}	$V_{BR} @ I_T$ (V) (Note 6)			I_T	$I_R @ V_{RWM}$	$V_C @ I_{PP}$	I_{PP} (A)
		(Note 5)	Min	Nom	Max	(mA)	(μA)	(V)	(Note 7)
1PMT5.0AT1G, T3G	MKE	5.0	6.4	6.7	7.0	10	50	9.2	21.7
1PMT7.0AT1G, T3G	MKM	7.0	7.78	8.2	8.6	10	30	12	16.7
1PMT12AT1G, T3G	MLE	12	13.3	14.0	14.7	1.0	1.0	19.9	10.1
1PMT16AT1G, T3G	MLP	16	17.8	18.75	19.7	1.0	1.0	26	7.7
1PMT18AT1G, T3G	MLT	18	20.0	21.0	22.1	1.0	1.0	29.2	6.8
1PMT22AT1G, T3G	MLX	22	24.4	25.6	26.9	1.0	1.0	35.5	5.6
1PMT24AT1G, T3G	MLZ	24	26.7	28.1	29.5	1.0	1.0	38.9	5.1
1PMT26AT1G, T3G	MME	26	28.9	30.4	31.9	1.0	1.0	42.1	4.8
1PMT28AT1G, T3G	MMG	28	31.1	32.8	34.4	1.0	1.0	45.4	4.4
1PMT30AT1G, T3G	MMK	30	33.3	35.1	36.8	1.0	1.0	48.4	4.1
1PMT33AT1G, T3G	MMM	33	36.7	38.7	40.6	1.0	1.0	53.3	3.8
1PMT36AT1G, T3G	MMP	36	40.0	42.1	44.2	1.0	1.0	58.1	3.4
1PMT40AT1G, T3G	MMR	40	44.4	46.8	49.1	1.0	1.0	64.5	2.7
1PMT48AT1G, T3G	MMX	48	53.3	56.1	58.9	1.0	1.0	77.4	2.3
1PMT51AT1G, T3G	MMZ	51	56.7	59.7	62.7	1.0	1.0	82.4	2.1
1PMT58AT1G, T3G	MNG	58	64.4	67.8	71.2	1.0	1.0	93.6	1.9

4. 1/2 sine wave (or equivalent square wave), PW = 8.3 ms, duty cycle = 4 pulses per minute maximum.

5. A transient suppressor is normally selected according to the Working Peak Reverse Voltage (V_{RWM}) which should be equal to or greater than the DC or continuous peak operating voltage level.

6. V_{BR} measured at pulse test current I_T at ambient temperature of 25°C .

7. Surge current waveform per Figure 2 and derate per Figure 4.

*The "G" suffix indicates Pb-Free package.

1PMT5.0AT1G/T3G Series

TYPICAL PROTECTION CIRCUIT

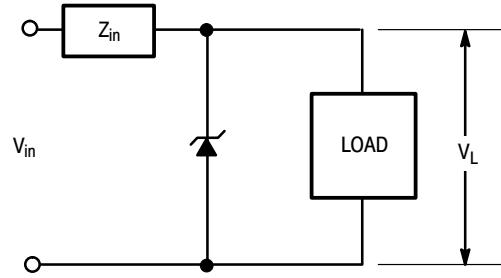

TYPICAL CHARACTERISTICS

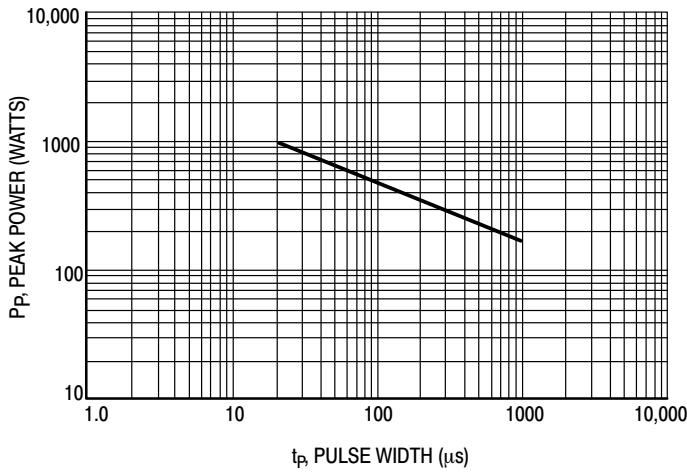

Figure 1. Pulse Rating Curve

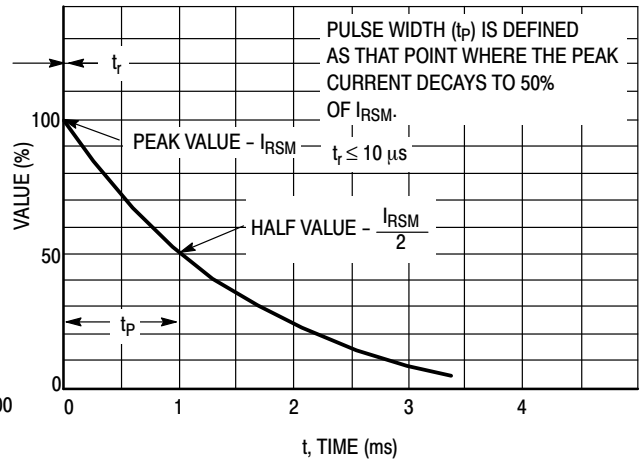

Figure 2. 10 X 1000 μ s Pulse Waveform

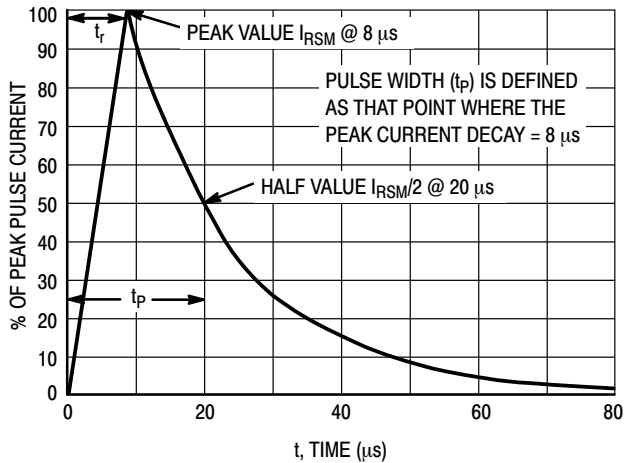

Figure 3. 8 X 20 μ s Pulse Waveform

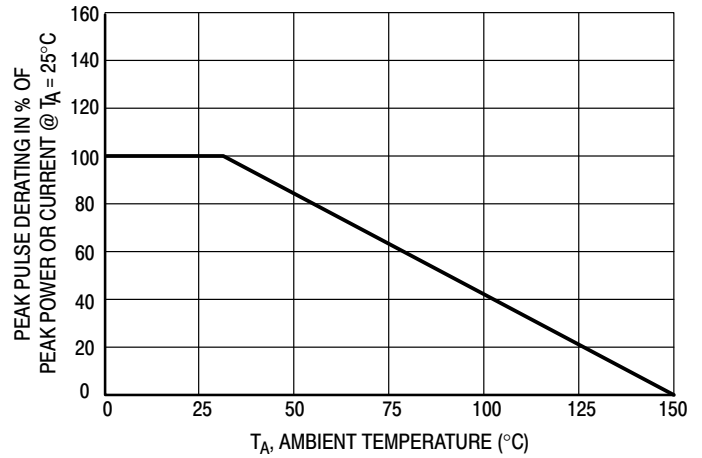

Figure 4. Pulse Derating Curve

1PMT5.0AT1G/T3G Series

TYPICAL CHARACTERISTICS

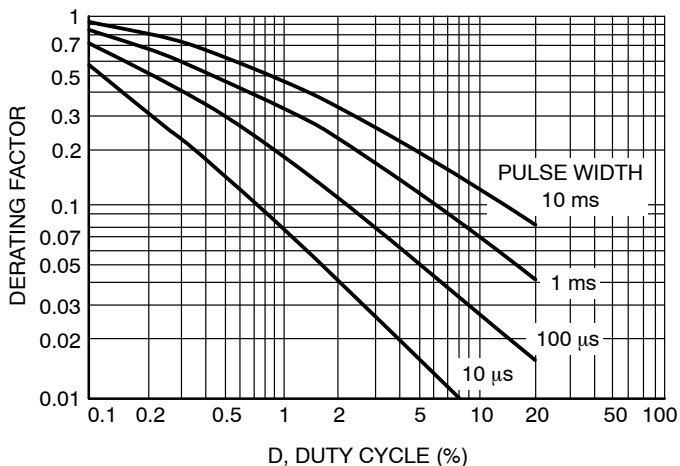

Figure 5. Typical Derating Factor for Duty Cycle

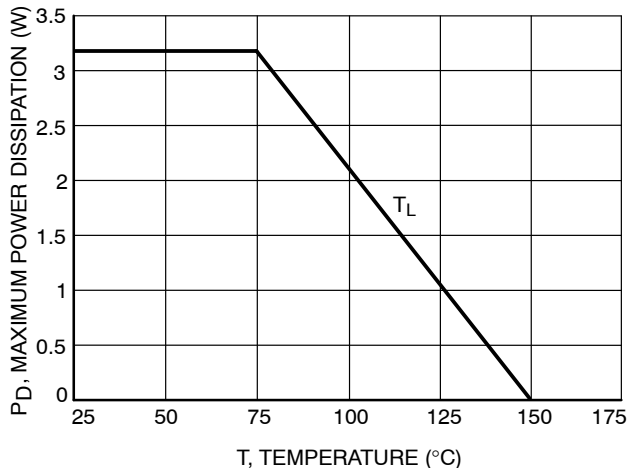

Figure 6. Steady State Power Derating

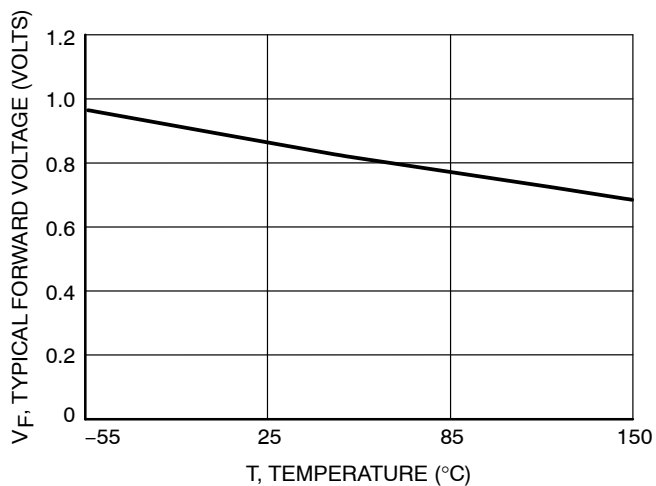

Figure 7. Forward Voltage

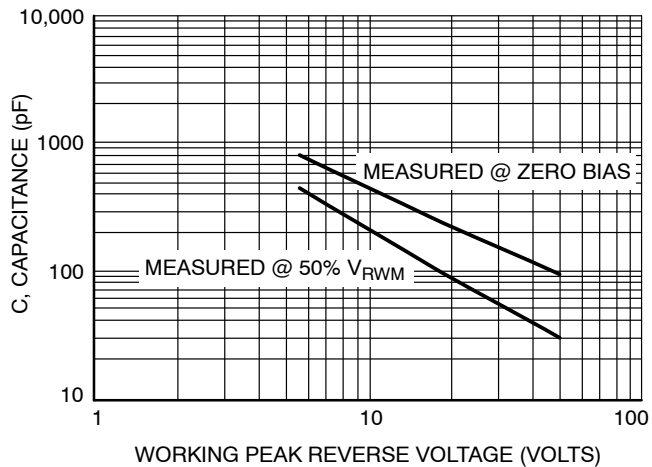
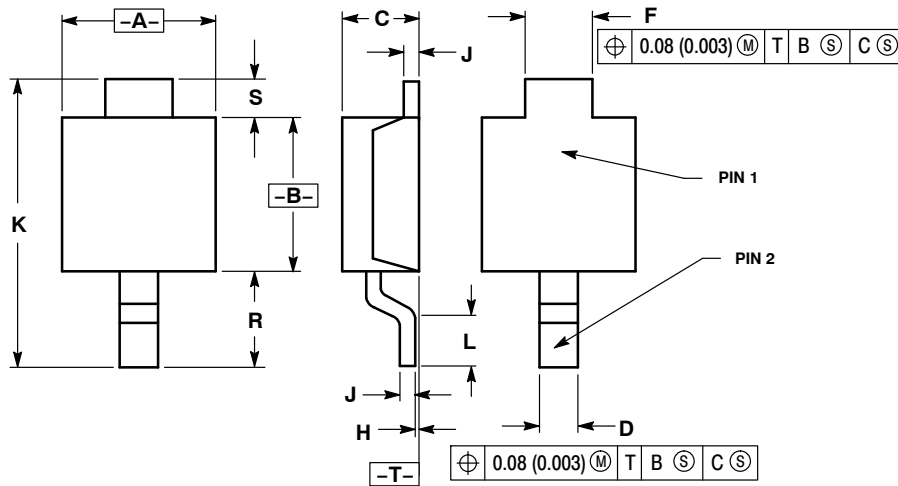

Figure 8. Capacitance versus Working Peak Reverse Voltage

1PMT5.0AT1G/T3G Series

PACKAGE DIMENSIONS

CASE 457-04
ISSUE F



NOTES:

1. DIMENSIONING AND TOLERANCING PER ANSI Y14.5M, 1982.
2. CONTROLLING DIMENSION: MILLIMETER.
3. DIMENSIONS A AND B DO NOT INCLUDE MOLD FLASH, PROTRUSIONS OR GATE BURRS. MOLD FLASH, PROTRUSIONS OR GATE BURRS SHALL NOT EXCEED 0.15 (0.006) PER SIDE.

DIM	MILLIMETERS		INCHES	
	MIN	MAX	MIN	MAX
A	1.75	2.05	0.069	0.081
B	1.75	2.18	0.069	0.086
C	0.85	1.15	0.033	0.045
D	0.40	0.69	0.016	0.027
F	0.70	1.00	0.028	0.039
H	-0.05	+0.10	-0.002	+0.004
J	0.10	0.25	0.004	0.010
K	3.60	3.90	0.142	0.154
L	0.50	0.80	0.020	0.031
R	1.20	1.50	0.047	0.059
S	0.50	REF	0.019	REF

SOLDERING FOOTPRINT*

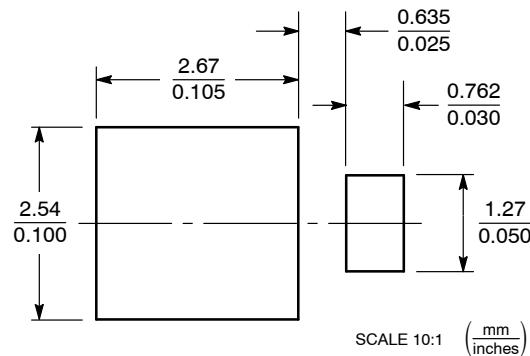

Littelfuse products are not designed for, and shall not be used for, any purpose (including, without limitation, automotive, military, aerospace, medical, life-saving, life-sustaining or nuclear facility applications, devices intended for surgical implant into the body, or any other application in which the failure or lack of desired operation of the product may result in personal injury, death, or property damage) other than those expressly set forth in applicable Littelfuse product documentation. Warranties granted by Littelfuse shall be deemed void for products used for any purpose not expressly set forth in applicable Littelfuse documentation. Littelfuse shall not be liable for any claims or damages arising out of products used in applications not expressly intended by Littelfuse as set forth in applicable Littelfuse documentation. The sale and use of Littelfuse products is subject to Littelfuse Terms and Conditions of Sale, unless otherwise agreed by Littelfuse.