

Video/Audio Interfaces for TV and DVD Recorders



# NTSC-PAL Audio I/O Interface for Recording/Playing BD3822FS, BD3824FS

---

### •Description

BD3822FS and BD3824FS are the audio selectors with internal input selector, gain amp, ALC and power save ON/OFF functions. BD3822FS contains the 1/2 power compression amp for level meter and 2ch volume. BD3824FS contains the line amp. BD3822FS and BD3824FS unify the board pattern by pin compatible, and can be used individually as a high-end and low-end model.

### •Features

- 1) Low distortion (0.0015%) and low noise (3.2 $\mu$ Vrms) by using a resistance ladder type circuit for volume. Shock sound in switching is also reduced (BD3822FS)
- 2) Low distortion (0.0015%) and low noises (2.3 $\mu$ Vrms)(BD3824FS)
- 3) Contains an ALC circuit, and can also be used as an RF output
- 4) Best suited to energy-saving design by low current consumption by using the Bi-CMOS process; compact regulator in the set, being advantageous to heating in terms of quality
- 5) SSOP-A32 is used for package. The PCB layout can be easy and the area of PCB is reduced by putting sound input terminals together, and output terminals, too.
- 6) BD3822FS and BD3824FS can be used with the same PCB board.
- 7) I<sup>2</sup>C BUS data format of BD3822FS is upward compatible with BD3824FS, and can be used without changing the software.
- 8) A system is employed, in which the waveform connected to the input (tuner, Front, Ext) is not distorted even in standby mode.

### •Applications

DVD recorder

### •Product lineup

Function	BD3822FS	BD3824FS
Volume function	Available	-
1/2 power compression amp	Available	-
Line amp	-	Available
Circuit current (mA)	7	6.4
Output noise ( $\mu$ Vrms)	3.2	2.3

BD3822FS is an upstream compatible IC with BD3824FS.

●Absolute maximum ratings (Ta=25°C)

Parameter	Symbol	Limits	Unit
Applied voltage	V <sub>CC</sub>	10.0	V
Input voltage	V <sub>IN</sub>	V <sub>CC</sub> +0.3~GND-0.3	V
Power Dissipation	P <sub>d</sub>	950 <sup>*1</sup>	mW
Operating temperature	T <sub>opr</sub>	-40~+85 <sup>*2</sup>	°C
Storage temperature	T <sub>stg</sub>	-55~+150	°C

\*1 Reduced by 7.6 mW/°C at 25°C or higher.

Thermal resistance  $\theta_{ja} = 131.6$  (°C/W), when Rohm standard board is mounted.

Rohm standard board : Size:70×70×1.6 (mm<sup>3</sup>)

Material: FR4 glass-epoxy substrate (copper foil area: not more than 3%).

\*2 As long as voltage stays within operating voltage range, certain circuit operation is guaranteed in the operating temperature range.

Allowable power loss conditions are related to temperature, to which care must be taken.

In addition though the standard value of its electrical characteristics cannot be guaranteed under the conditions other than those specified, basic functions are maintained.

●Operating range (Basic operation at Ta=25°C)

Parameter	Symbol	Min.	Typ.	Max.	Unit
Power Supply voltage <sup>*3</sup>	V <sub>CC</sub>	7.0	-	9.5	V

\*3 As long as temperature and operating voltage meet specifications

In addition, though the standard value of its electrical characteristics cannot be guaranteed under the conditions other than those specified, basic functions are maintained.

● Electric characteristics BD3822FS

(Unless specified: Ta=25°C, VCC=9V, f=1kHz, VIN=1Vrms, Rg=600Ω, RL=10kΩ, Gain Amp=0dB, Volume=0dB, Input terminal=Front1, Output Terminal=OUT1)

	Parameter	Symbol	Limits			Unit	Conditions
			Min.	Typ.	Max.		
GENERAL	Circuit current upon no signal	IQ	-	7	30	mA	VIN=0Vrms
	Standby current	I <sub>OFF</sub>	-	540	1000	μA	「Power OFF」 MODE
	Voltage gain	G <sub>V</sub>	-1.5	0	1.5	dB	G <sub>V</sub> =20log(V <sub>OUT</sub> /V <sub>IN</sub> )
	Maximum output voltage	V <sub>OM</sub>	2.0	2.5	-	Vrms	V <sub>OM</sub> at THD(V <sub>OUT</sub> )=1% BW=400-30KHz
	Channel balance	CB	-1.5	0	1.5	dB	CB = G <sub>V1</sub> -G <sub>V2</sub> G <sub>V1</sub> :ch1Gain G <sub>V2</sub> :ch2 Gain
	Total harmonic distortion	THD	-	0.0015	0.05	%	VIN=2Vrms,Volume=-12dB Gain Amp=5.6dB,BW=400-30KHz
	Output noise voltage *	V <sub>NO</sub>	-	3.2	16	μVrms	Volume=-12dB,Gain Amp=5.6dB Rg = 0Ω, BW=IHF-A
	Residual noise voltage *	V <sub>NOR</sub>	-	2	10	μVrms	Volume = -∞dB,Rg = 0Ω, BW=IHF-A
	Cross-talk between channels *	CTC	-	-110	-80	dB	Rg = 0Ω、BW = IHF-A
INPUT	Input impedance	R <sub>IN</sub>	77	110	143	kΩ	*1)
	Maximum input voltage	V <sub>IM</sub>	2.1	2.5	-	Vrms	V <sub>IM</sub> at THD(V <sub>OUT</sub> )=1% BW=400-30KHz *1)
	Cross-talk between selector	CTS	-	-110	-80	dB	Rg = 0Ω、BW = IHF-A CTS=20log(V <sub>OUT</sub> /V <sub>IN</sub> )
	Tuner gain	G <sub>TU</sub>	10	12	14	dB	Tuner gain=12dB, VIN=0.25Vrms G=20log(V <sub>OUT</sub> /V <sub>IN</sub> )
	Output offset voltage	V <sub>DC</sub>	-20	0	20	mV	Tuner SAP↔Front1
VOLUME	Volume control range	V <sub>V1</sub>	-81	-78	-75	dB	G <sub>V</sub> =20log(V <sub>OUT</sub> /V <sub>IN</sub> ),BW = IHF-A
	Maximum attenuation	G <sub>V MIN1</sub>	-	-106	-85	dB	Volume = -∞dB, BW = IHF-A G <sub>V</sub> =20log(V <sub>OUT</sub> /V <sub>IN</sub> )
	Step resolution 1	G <sub>V STEP1</sub>	-	1	-	dB	Volume=0~-46dB
	Step resolution 2	G <sub>V STEP2</sub>	-	2	-	dB	Volume=-46~-78dB
	Attenuation set error 1	G <sub>V ERR1</sub>	-2	0	2	dB	Volume=0~-58dB
	Attenuation set error 2	G <sub>V ERR2</sub>	-3	0	3	dB	Volume=-60~-78dB
GAIN AMP	Minimum gain	G <sub>MIN</sub>	-1.5	0	1.5	dB	Gain Amp=0dB,G=20log(V <sub>OUT</sub> /V <sub>IN</sub> )
	Maximum gain	G <sub>MAX</sub>	4.5	6	7.5	dB	Gain Amp=6dB,VIN=500mVrms G=20log(V <sub>OUT</sub> /V <sub>IN</sub> )
	Step resolution	G <sub>STEP</sub>	-	0.2	-	dB	4.6dB to 5.6dB
	Gain set error	G <sub>ERR</sub>	-1.5	0	1.5	dB	
MUTE	Mute attenuation	G <sub>MUTE</sub>	-	-110	-85	dB	Mute ON G <sub>MUTE</sub> =20log(V <sub>OUT</sub> /V <sub>IN</sub> ) BW = IHF-A Volume=-∞dB, or -78dB
ALC	ALC I/O level 1	ALC1	-	-3	0	dBV	Suppression level is set to -3dBV.
	ALC I/O level 2	ALC2	-	-5	-2	dBV	Suppression level is set to -5dBV.
	ALC I/O level 3	ALC3	-	-7	-4	dBV	Suppression level is set to -7dBV.
Square-Law Compression Amp	Output offset voltage	V <sub>DC OFF</sub>	-	30	100	mV	VIN = 0dBV
	DC maximum output voltage	V <sub>DC MAX</sub>	2.9	3.7	-	V	VIN = +6dBV
	DC standard output voltage	V <sub>DC ST</sub>	1.1	1.5	1.9	V	VIN = -10dBV
	DC voltage difference between channels	ΔV <sub>DC</sub>	-250	0	250	mV	VIN = -10dBV
	DC output voltage linearity	ΔV <sub>DC</sub> / ΔVIN	0.9	1.4	1.9	V	VIN = -30~-6dBV

\*1: 1) Refers to 1,2,3,9,10,11,12,13,14,25,26,31,32 pin terminals.

● **Electric characteristics** BD3824FS

(Unless specified: Ta=25°C, VCC=9V, f=1kHz, VIN=1Vrms, Rg=600Ω, RL=10kΩ, Gain Amp=0dB, Volume=0dB, Input terminal=Front1, Output Terminal=OUT1)

	Parameter	Symbol	Limits			Unit	Conditions
			Min.	Typ.	Max.		
GENERAL	Circuit current upon no signal	IQ	-	6.4	19.2	mA	VIN=0Vrms
	Standby current	I <sub>OFF</sub>	-	940	1760	μA	「Power OFF」 MODE
	Voltage gain	Gv	-7.6	-6.1	-4.6	dB	Gv=20log(VOUT/VIN), RL2=10kΩ
	Maximum output voltage 1	VOM1	1.68	2.1	-	Vrms	Output terminal = OUT1/OUT2, RL2=10kΩ Vom at THD(VOUT)=1% Gain Amp=5dB, BW=400-30kHz
	Maximum output voltage 2	VOM2	2.0	2.5	-	Vrms	Output terminal=RF OUT Vom at THD(VOUT)=1% ALC=OFF, RL2=10kΩ BW=400-30kHz
	Maximum output voltage 3	VOM3	2.2	2.5	-	Vrms	Output terminal= LINE OUT1/LINE OUT2 Vom at THD(VOUT)=1% RL1=4.7kΩ External LPF Gvc=6dB BW=400-30kHz
	Channel balance	CB	-1.5	0	1.5	dB	CB = Gv1-Gv2 Gv1:ch1Gain Gv2:ch2 Gain
	Total harmonic distortion	THD	-	0.0015	0.05	%	VIN=2Vrms, BW=400-30KHz
	Output noise voltage *	VNO	-	2.3	11.5	μVrms	Rg = 0Ω, BW=IHF-A
	Cross-talk between channels *	CTC	-	-100	-80	dB	Rg = 0Ω, BW = IHF-A
INPUT	Input impedance	RIN	77	110	143	kΩ	*2)
	Maximum input voltage	VIM	2.1	2.5	-	Vrms	VIM at THD(VOUT)=1% BW=400-30KHz*2)
	Cross-talk between selector *	CTS	-	-105	-80	dB	Rg = 0Ω, BW = IHF-A CTS=20log(VOUT/VIN)
	Tuner gain	GTU	10	12	14	dB	Tuner gain=12dB VIN=0.25Vrms, G=20log(VOUT/VIN)
	Output offset voltage	VDC	-20	0	20	mV	Tuner1↔Front1, Tuner Gain = 8dB
GAINAMP	Minimum gain	GMIN	-1.5	0	1.5	dB	Gain Amp=0dB G=20log(VOUT/VIN)
	Maximum gain	GMAX	3.5	5	6.5	dB	Gain Amp=5dB, VIN=500mVrms G=20log(VOUT/VIN)
RF MUTE	Mute attenuation	GMUTE	-	-110	-85	dB	Mute ON, BW = IHF-A GMUTE=20log(VOUT/VIN)
ALC	ALC I/O level 1	ALC1	-	-3	0	dBV	Suppression level is set to -3dBV.
	ALC I/O level 2	ALC2	-	-5	-2	dBV	Suppression level is set to -5dBV.
	ALC I/O level 3	ALC3	-	-7	-4	dBV	Suppression level is set to -7dBV.

1. \*2) Refers to 2,3,9,10,11,12,13,14,31,32pin terminals.

2. VP-9690A (Average value detection, effective value display) IHF-A filter by Matsushita Communication is used for measurement.

3. Phase between input/output is the same.

4. This IC is not designed to be radiation-resistant.

●Example of application circuit

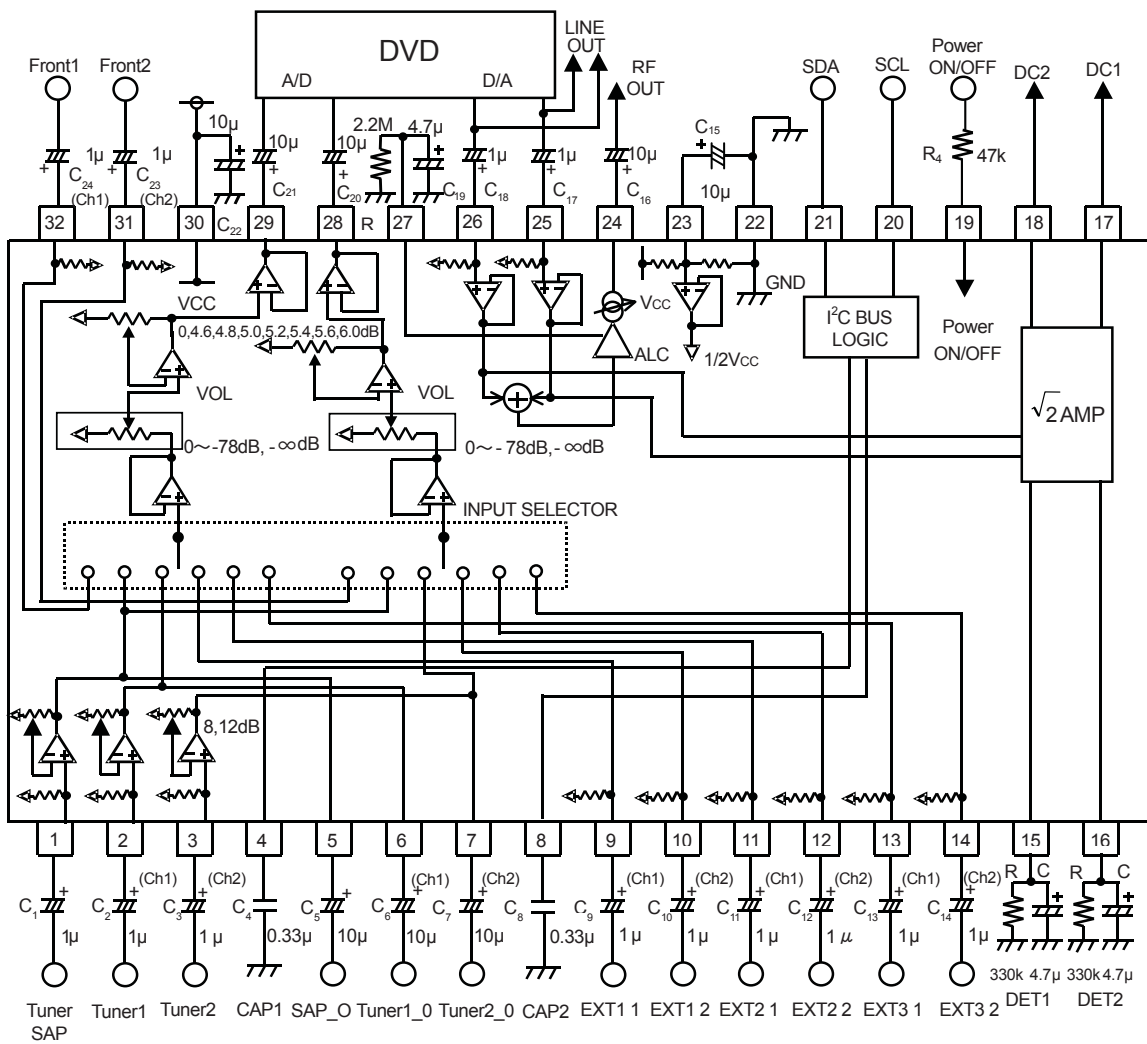

Unit  
R : [Ω]  
C : [F]

Fig.1 Example of application circuit (BD3822FS)

●Example of application circuit

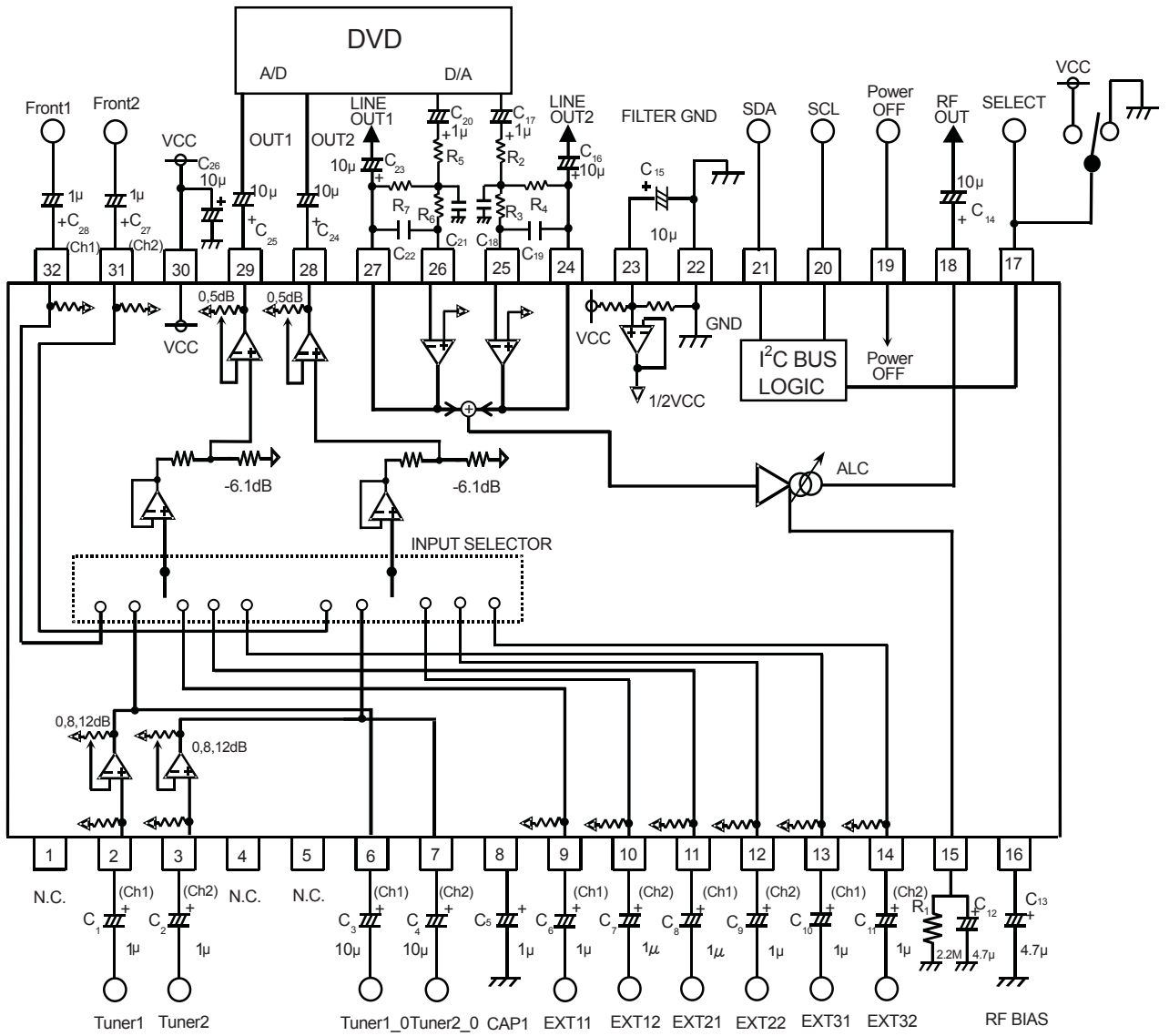

Fig.2 Example of application circuit (BD3824FS)

Unit  
R : [Ω]  
C : [F]

●Reference data

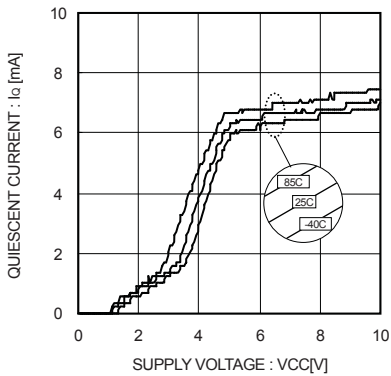

Fig.3 Quiescent current vs Supply voltage (BD3822FS)

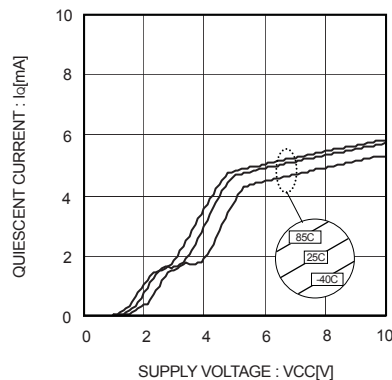

Fig.4 Quiescent current vs Supply voltage (BD3824FS)

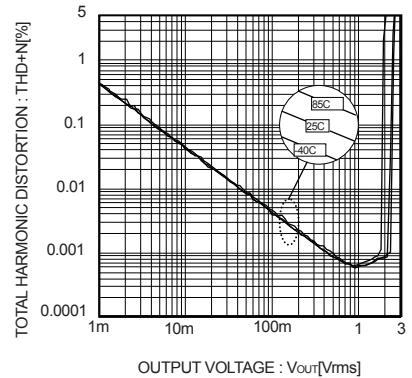

Fig.5 Total harmonic distortion vs Output voltage (BD3822FS)

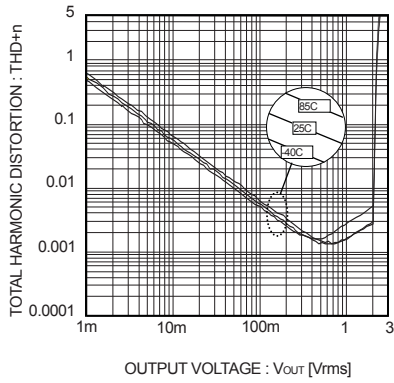

Fig.6 Total harmonic distortion vs Output voltage (BD3824FS)

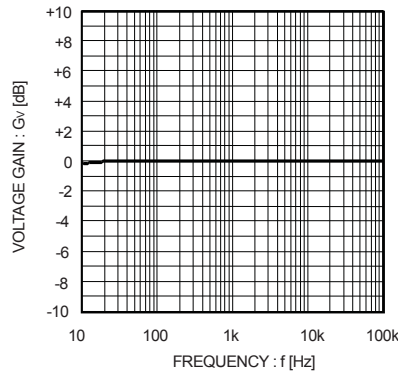

Fig.7 Voltage gain vs Frequency (BD3822FS)

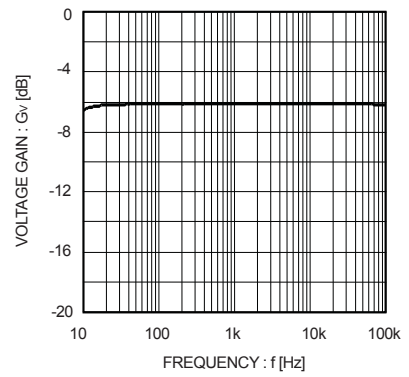

Fig.8 Voltage gain vs Frequency (BD3824FS)

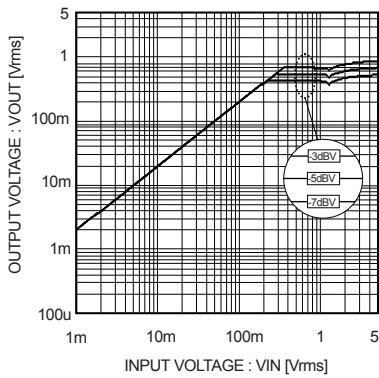

Fig.9 ALC I/O characteristic (BD3822FS)

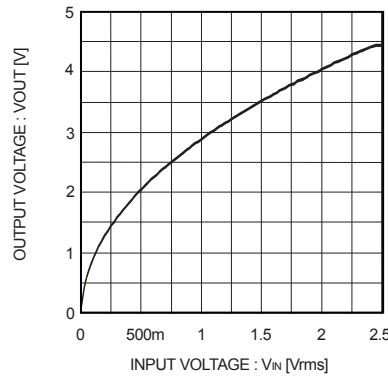

Fig.10 Square-Low Compression amp I/O characteristic (BD3824FS)

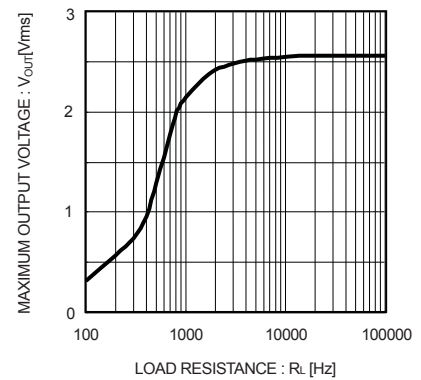
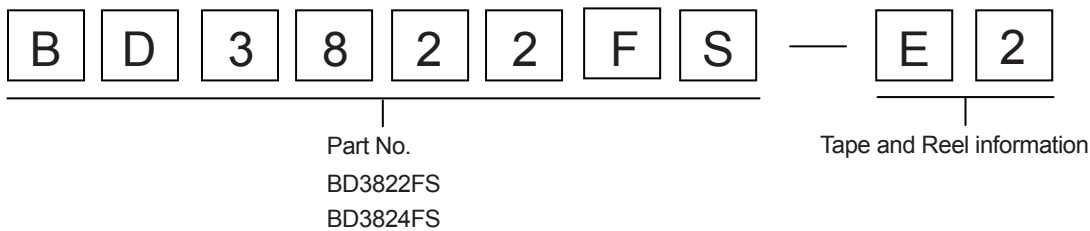

Fig.11 Output load characteristic (BD3822FS, BD3824FS)

## ●Operation Notes

1. Numbers and data in entries are representative design values and are not guaranteed values of the items.
2. Although ROHM is confident that the example application circuit reflects the best possible recommendations, be sure to verify circuit characteristics for your particular application. Modification of constants for other externally connected circuits may cause variations in both static and transient characteristics for external components as well as this Rohm IC. Allow for sufficient margins when determining circuit constants.
3. Absolute maximum ratings  
Use of the IC in excess of absolute maximum ratings, such as the applied voltage or operating temperature range ( $T_{opr}$ ), may result in IC damage. Assumptions should not be made regarding the state of the IC (short mode or open mode) when such damage is suffered. A physical safety measure, such as a fuse, should be implemented when using the IC at times where the absolute maximum ratings may be exceeded.
4. GND potential  
Ensure a minimum GND pin potential in all operating conditions. Make sure that no pins are at a voltage below the GND at any time, regardless of whether it is a transient signal or not.
5. Thermal design  
Perform thermal design, in which there are adequate margins, by taking into account the permissible dissipation ( $P_d$ ) in actual states of use.
6. Short circuit between terminals and erroneous mounting  
Pay attention to the assembly direction of the ICs. Wrong mounting direction or shorts between terminals, GND, or other components on the circuits, can damage the IC.
7. Operation in strong electromagnetic field  
Using the ICs in a strong electromagnetic field can cause operation malfunction.

● Selection of order type



SSOP-A32

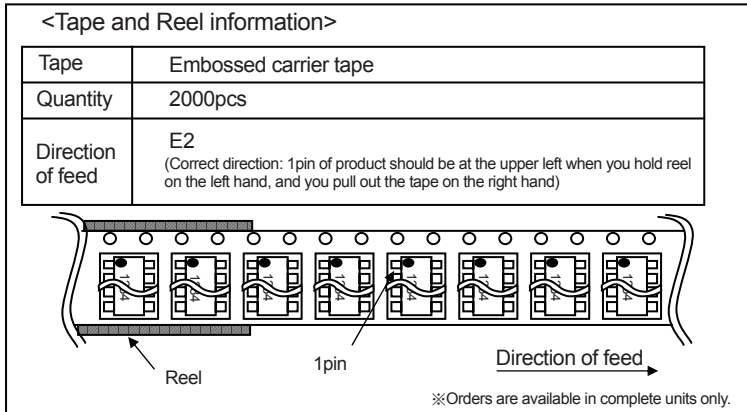
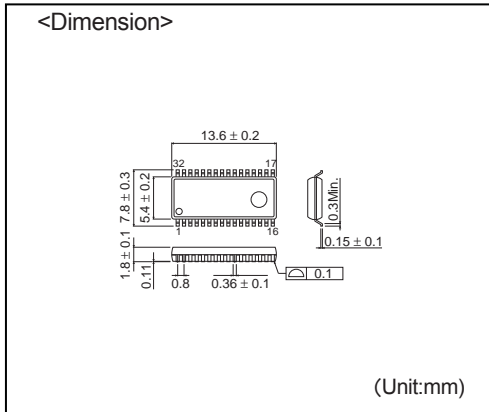

- The contents described herein are correct as of October, 2005
- The contents described herein are subject to change without notice. For updates of the latest information, please contact and confirm with ROHM CO.,LTD.
- Any part of this application note must not be duplicated or copied without our permission.
- Application circuit diagrams and circuit constants contained herein are shown as examples of standard use and operation. Please pay careful attention to the peripheral conditions when designing circuits and deciding upon circuit constants in the set.
- Any data, including, but not limited to application circuit diagrams and information, described herein are intended only as illustrations of such devices and not as the specifications for such devices. ROHM CO.,LTD. disclaims any warranty that any use of such devices shall be free from infringement of any third party's intellectual property rights or other proprietary rights, and further, assumes no liability of whatsoever nature in the event of any such infringement, or arising from or connected with or related to the use of such devices.
- Upon the sale of any such devices, other than for buyer's right to use such devices itself, resell or otherwise dispose of the same, implied right or license to practice or commercially exploit any intellectual property rights or other proprietary rights owned or controlled by ROHM CO., LTD. is granted to any such buyer.
- The products described herein utilize silicon as the main material.
- The products described herein are not designed to be X ray proof.

The products listed in this catalog are designed to be used with ordinary electronic equipment or devices (such as audio visual equipment, office-automation equipment, communications devices, electrical appliances and electronic toys). Should you intend to use these products with equipment or devices which require an extremely high level of reliability and the malfunction of which would directly endanger human life (such as medical instruments, transportation equipment, aerospace machinery, nuclear-reactor controllers, fuel controllers and other safety devices), please be sure to consult with our sales representative in advance.

Excellence in Electronics



ROHM CO., LTD.

21, Saiin Mizosaki-cho, Ukyo-ku, Kyoto  
615-8585, Japan  
TEL: (075)311-2121 FAX: (075)315-0172  
URL <http://www.rohm.com>

Published by  
Application Engineering Group

Contact us for further information about the products.

- Atlanta U.S.A. / ROHM ELECTRONICS ATLANTA SALES OFFICE  
(DIVISION OF ROHM ELE.U.S.A.,LLC)  
TEL: +1(770)754-8972 FAX: +1(770)754-0891
- Dallas U.S.A. / ROHM ELECTRONICS DALLAS SALES OFFICE  
(DIVISION OF ROHM ELE.U.S.A.,LLC)  
TEL: +1(972)312-8818 FAX: +1(972)312-0330
- San Diego U.S.A. / ROHM ELECTRONICS SAN DIEGO SALES OFFICE  
(DIVISION OF ROHM ELE.U.S.A.,LLC)  
TEL: +1(858)625-3630 FAX: +1(858)625-3670
- Germany / ROHM ELECTRONICS GMBH (GERMANY)  
TEL: +49(2154)9210 FAX: +49(2154)921400
- United Kingdom / ROHM ELECTRONICS GMBH (UK)  
TEL: +44(0)1908-306700 FAX: +44(0)1908-235788
- France / ROHM ELECTRONICS GMBH (FRANCE)  
TEL: +33(0)1 56 97 30 60 FAX: +33(0)1 56 97 30 80
- Hong Kong China / ROHM ELECTRONICS (H.K.) CO., LTD.  
TEL: +852(2)7406262 FAX: +852(2)375-8971
- Shanghai China / ROHM ELECTRONICS (SHANGHAI) CO., LTD.  
TEL: +86(21)6279-2727 FAX: +86(21)6247-2066
- Dalian China / ROHM ELECTRONICS TRADING (DALIAN) CO., LTD.  
TEL: +86(411)8230-8549 FAX: +86(411)8230-8497

- Beijing China / BEIJING REPRESENTATIVE OFFICE  
TEL: +86(10)6525-2483 FAX: +86(10)8525-2489
- Taiwan / ROHM ELECTRONICS TAIWAN CO., LTD.  
TEL: +886(2)2500-6956 FAX: +886(2)2503-2869
- Korea / ROHM ELECTRONICS KOREA CORPORATION  
TEL: +82(2)8182-7000 FAX: +82(2)8182-715
- Singapore / ROHM ELECTRONICS ASIA PTE. LTD. (RES/REI)  
TEL: +65-6332-2322 FAX: +65-6332-6362
- Malaysia / ROHM ELECTRONICS (MALAYSIA) SDN. BHD.  
TEL: +60(3)7958-6355 FAX: +60(3)7958-8377
- Philippines / ROHM ELECTRONICS (PHILIPPINES) SALES CORPORATION  
TEL: +63(2)807-6872 FAX: +63(2)809-1422
- Thailand / ROHM ELECTRONICS (THAILAND) CO., LTD.  
TEL: +66(2)254-4890 FAX: +66(2)256-6334



### Notes

- No technical content pages of this document may be reproduced in any form or transmitted by any means without prior permission of ROHM CO.,LTD.
- The contents described herein are subject to change without notice. The specifications for the product described in this document are for reference only. Upon actual use, therefore, please request that specifications to be separately delivered.
- Application circuit diagrams and circuit constants contained herein are shown as examples of standard use and operation. Please pay careful attention to the peripheral conditions when designing circuits and deciding upon circuit constants in the set.
- Any data, including, but not limited to application circuit diagrams information, described herein are intended only as illustrations of such devices and not as the specifications for such devices. ROHM CO.,LTD. disclaims any warranty that any use of such devices shall be free from infringement of any third party's intellectual property rights or other proprietary rights, and further, assumes no liability of whatsoever nature in the event of any such infringement, or arising from or connected with or related to the use of such devices.
- Upon the sale of any such devices, other than for buyer's right to use such devices itself, resell or otherwise dispose of the same, no express or implied right or license to practice or commercially exploit any intellectual property rights or other proprietary rights owned or controlled by
- ROHM CO., LTD. is granted to any such buyer.
- Products listed in this document are no antiradiation design.

The products listed in this document are designed to be used with ordinary electronic equipment or devices (such as audio visual equipment, office-automation equipment, communications devices, electrical appliances and electronic toys).

Should you intend to use these products with equipment or devices which require an extremely high level of reliability and the malfunction of which would directly endanger human life (such as medical instruments, transportation equipment, aerospace machinery, nuclear-reactor controllers, fuel controllers and other safety devices), please be sure to consult with our sales representative in advance.

It is our top priority to supply products with the utmost quality and reliability. However, there is always a chance of failure due to unexpected factors. Therefore, please take into account the derating characteristics and allow for sufficient safety features, such as extra margin, anti-flammability, and fail-safe measures when designing in order to prevent possible accidents that may result in bodily harm or fire caused by component failure. ROHM cannot be held responsible for any damages arising from the use of the products under conditions out of the range of the specifications or due to non-compliance with the NOTES specified in this catalog.

Thank you for your accessing to ROHM product informations.

More detail product informations and catalogs are available, please contact your nearest sales office.

**ROHM** Customer Support System

THE AMERICAS / EUROPE / ASIA / JAPAN

[www.rohm.com](http://www.rohm.com)

Contact us : [webmaster@rohm.co.jp](mailto:webmaster@rohm.co.jp)