



**MM7150 Motion Module PICtail™
Plus Evaluation Board (#AC243007)
with Explorer 16 Development Board
User's Guide**

Object of Declaration: MM7150 Motion Module PICtail™ Plus Evaluation Board (#AC243007) with Explorer 16 Development Board

EU Declaration of Conformity

Manufacturer: Microchip Technology Inc.
2355 W. Chandler Blvd.
Chandler, Arizona, 85224-6199
USA

This declaration of conformity is issued by the manufacturer.

The development/evaluation tool is designed to be used for research and development in a laboratory environment. This development/evaluation tool is not a Finished Appliance, nor is it intended for incorporation into Finished Appliances that are made commercially available as single functional units to end users under EU EMC Directive 2004/108/EC and as supported by the European Commission's Guide for the EMC Directive 2004/108/EC (8th February 2010).

This development/evaluation tool complies with EU RoHS2 Directive 2011/65/EU.

This development/evaluation tool, when incorporating wireless and radio-telecom functionality, is in compliance with the essential requirement and other relevant provisions of the R&TTE Directive 1999/5/EC and the FCC rules as stated in the declaration of conformity provided in the module datasheet and the module product page available at www.microchip.com.

For information regarding the exclusive, limited warranties applicable to Microchip products, please see Microchip's standard terms and conditions of sale, which are printed on our sales documentation and available at www.microchip.com.

Signed for and on behalf of Microchip Technology Inc. at Chandler, Arizona, USA

Derek Carlson
VP Development Tools

12-Sep-14
Date

Note the following details of the code protection feature on Microchip devices:

- Microchip products meet the specification contained in their particular Microchip Data Sheet.
- Microchip believes that its family of products is one of the most secure families of its kind on the market today, when used in the intended manner and under normal conditions.
- There are dishonest and possibly illegal methods used to breach the code protection feature. All of these methods, to our knowledge, require using the Microchip products in a manner outside the operating specifications contained in Microchip's Data Sheets. Most likely, the person doing so is engaged in theft of intellectual property.
- Microchip is willing to work with the customer who is concerned about the integrity of their code.
- Neither Microchip nor any other semiconductor manufacturer can guarantee the security of their code. Code protection does not mean that we are guaranteeing the product as “unbreakable.”

Code protection is constantly evolving. We at Microchip are committed to continuously improving the code protection features of our products. Attempts to break Microchip's code protection feature may be a violation of the Digital Millennium Copyright Act. If such acts allow unauthorized access to your software or other copyrighted work, you may have a right to sue for relief under that Act.

Information contained in this publication regarding device applications and the like is provided only for your convenience and may be superseded by updates. It is your responsibility to ensure that your application meets with your specifications. MICROCHIP MAKES NO REPRESENTATIONS OR WARRANTIES OF ANY KIND WHETHER EXPRESS OR IMPLIED, WRITTEN OR ORAL, STATUTORY OR OTHERWISE, RELATED TO THE INFORMATION, INCLUDING BUT NOT LIMITED TO ITS CONDITION, QUALITY, PERFORMANCE, MERCHANTABILITY OR FITNESS FOR PURPOSE. Microchip disclaims all liability arising from this information and its use. Use of Microchip devices in life support and/or safety applications is entirely at the buyer's risk, and the buyer agrees to defend, indemnify and hold harmless Microchip from any and all damages, claims, suits, or expenses resulting from such use. No licenses are conveyed, implicitly or otherwise, under any Microchip intellectual property rights unless otherwise stated.

Trademarks

The Microchip name and logo, the Microchip logo, dsPIC, FlashFlex, flexPWR, JukeBlox, KEELOQ, KEELOQ logo, Kleer, LANCheck, MediaLB, MOST, MOST logo, MPLAB, OptoLyzer, PIC, PICSTART, PIC³² logo, RightTouch, SpyNIC, SST, SST Logo, SuperFlash and UNI/O are registered trademarks of Microchip Technology Incorporated in the U.S.A. and other countries.

The Embedded Control Solutions Company and mTouch are registered trademarks of Microchip Technology Incorporated in the U.S.A.

Analog-for-the-Digital Age, BodyCom, chipKIT, chipKIT logo, CodeGuard, dsPICDEM, dsPICDEM.net, ECAN, In-Circuit Serial Programming, ICSP, Inter-Chip Connectivity, KleerNet, KleerNet logo, MiWi, MPASM, MPF, MPLAB Certified logo, MPLIB, MPLINK, MultiTRAK, NetDetach, Omniscient Code Generation, PICDEM, PICDEM.net, PICKit, PICTail, RightTouch logo, REAL ICE, SQI, Serial Quad I/O, Total Endurance, TSHARC, USBCheck, VariSense, ViewSpan, WiperLock, Wireless DNA, and ZENA are trademarks of Microchip Technology Incorporated in the U.S.A. and other countries.

SQTP is a service mark of Microchip Technology Incorporated in the U.S.A.

Silicon Storage Technology is a registered trademark of Microchip Technology Inc. in other countries.

GestIC is a registered trademarks of Microchip Technology Germany II GmbH & Co. KG, a subsidiary of Microchip Technology Inc., in other countries.

All other trademarks mentioned herein are property of their respective companies.

© 2014 - 2015, Microchip Technology Incorporated, Printed in the U.S.A., All Rights Reserved.

ISBN: 9781632775498

QUALITY MANAGEMENT SYSTEM
CERTIFIED BY DNV
== ISO/TS 16949 ==

Microchip received ISO/TS-16949:2009 certification for its worldwide headquarters, design and wafer fabrication facilities in Chandler and Tempe, Arizona; Gresham, Oregon and design centers in California and India. The Company's quality system processes and procedures are for its PIC® MCUs and dsPIC® DSCs, KEELOQ® code hopping devices, Serial EEPROMs, microperipherals, nonvolatile memory and analog products. In addition, Microchip's quality system for the design and manufacture of development systems is ISO 9001:2000 certified.



Table of Contents

Preface	6
Introduction.....	6
Document Layout	6
Audience	7
Reference Documents.....	7
Glossary	7
The Microchip Web Site	7
Development Systems Customer Change Notification Service	8
Customer Support	8
Document Revision History	9
Chapter 1. Hardware Setup	
1.1 Hardware Requirements	10
1.2 Preparing the Explorer 16 Development Board	10
1.3 Hardware Connections for MM7150-PICTAIL to Explorer 16 Development Board	10
1.3.1 Direct Plug-In	10
1.3.2 Using Extension Cable	11
Chapter 2. Software/Firmware Setup	
2.1 Software/Firmware requirements	12
2.2 MPLABX Project:	12
Chapter 3. Demo Setup	
3.1 Running the Motion demo	15
3.2 Calibrating Sensors	16
3.3 Sensor Data Display	17
3.4 Sleep/Wake	18
3.5 Flash Update	18
3.5.1 Flash Update command	19
3.5.2 Flash Configuration Update Command	21
Chapter 4. Troubleshooting	
4.1 Failure to Display Welcome Screen	27
4.2 Error Handling	28
4.2.1 General Error Handling for VREG Functions	28
4.2.2 I ² C Error Handling	29
4.2.3 Error Definitions (from source/headers/err.h)	30
Appendix A. Code Structure	
A.1 Directory structure	31
A.2 Program Flow	33

A.2.1 Main.c	33
A.2.2 Configuring and Initializing MM7150 Motion Module	33
A.2.3 Enabling Sensors and Reading data	33
Appendix B. Reference Schematic & Bill of Materials	
B.1 MM7150 Motion Module PICTail™ Plus Evaluation Board	34
B.1.1 Bill of Materials	34
B.1.2 Reference Schematic	34
Appendix C. Extension Cable for Explorer 16	
C.1 Signals Connection	36
Worldwide Sales and Service	37



Preface

NOTICE TO CUSTOMERS

All documentation becomes dated, and this manual is no exception. Microchip tools and documentation are constantly evolving to meet customer needs, so some actual dialogs and/or tool descriptions may differ from those in this document. Please refer to our web site (www.microchip.com) to obtain the latest documentation available.

Documents are identified with a “DS” number. This number is located on the bottom of each page, in front of the page number. The numbering convention for the DS number is “DSXXXXA”, where “XXXX” is the document number and “A” is the revision level of the document.

For the most up-to-date information on development tools, see the MPLAB® IDE online help. Select the Help menu, and then Topics to open a list of available online help files.

INTRODUCTION

This chapter contains general information that will be useful to know before using the MM7150 Motion Module PICTail™ Plus Evaluation Board (#AC243007) with the Explorer 16 development board (#DM240001) to run the demo and sample code. Items discussed in this chapter include:

- [Document Layout](#)
- [Audience](#)
- [Reference Documents](#)
- [Glossary](#)
- [The Microchip Web Site](#)
- [Development Systems Customer Change Notification Service](#)
- [Customer Support](#)
- [Document Revision History](#)

DOCUMENT LAYOUT

This document describes how to use the MM7150-PICTAIL with Explorer 16 Development Board to perform the demo and modify sample code. The manual layout is as follows:

- **Chapter 1. “Hardware Setup”** – Provides hardware setting information.
- **Chapter 2. “Software/Firmware Setup”** – Provides software and firmware setting and build information.
- **Chapter 3. “Demo Setup”** – Includes demonstration procedures.
- **Chapter 4. “Troubleshooting”** – Provides troubleshooting information.
- **Appendix A. “Code Structure”** – Provides sample code structure information.

- **Appendix B. “Reference Schematic & Bill of Materials”** – Provides MM7150-PICTAIL adapter reference schematic & bill of materials information.
- **Appendix C. “Extension Cable for Explorer 16”** – Provides signals connection information for building a custom extension cable to use with MM7150-PICTAIL.

AUDIENCE

This document is written for developers who are familiar with 9-axis motion sensor applications. The purpose of this document is to describe the functions and use of the MM7150-PICTAIL with Explorer 16 Development Board to perform the demos and modify sample code functions as described in the Host API Design for MM7150 Application Note.

REFERENCE DOCUMENTS

- DS00001885A - MM7150 Motion Coprocessor Data Sheet
- DS00001888A - MM7150 Motion Module Data Sheet
- DS00001873A - Host API Design for MM7150 Motion Module Application Note

Note: Please contact your Microchip representative for the above documents and availability.

GLOSSARY

This section describes glossary terms and acronyms used in this document.

TERM	DEFINITION
EVB	Evaluation Board
HID	Human Interface Device
I ² C	Inter-Integrated Circuit
USB	Universal Serial Bus
EC	Embedded Controller
SF	Sensor Fusion

THE MICROCHIP WEB SITE

Microchip provides online support via our web site at www.microchip.com. This web site is used as a means to make files and information easily available to customers. Accessible by using your favorite Internet browser, the web site contains the following information:

- **Product Support** – Data sheets and errata, application notes and sample programs, design resources, user’s guides and hardware support documents, latest software releases and archived software
- **General Technical Support** – Frequently Asked Questions (FAQs), technical support requests, online discussion groups, Microchip consultant program member listing
- **Business of Microchip** – Product selector and ordering guides, latest Microchip press releases, listing of seminars and events, listings of Microchip sales offices, distributors and factory representatives

DEVELOPMENT SYSTEMS CUSTOMER CHANGE NOTIFICATION SERVICE

Microchip's customer notification service helps keep customers current on Microchip products. Subscribers will receive e-mail notification whenever there are changes, updates, revisions or errata related to a specified product family or development tool of interest.

To register, access the Microchip web site at www.microchip.com, click on Customer Change Notification and follow the registration instructions.

The Development Systems product group categories are:

- **Compilers** – The latest information on Microchip C compilers, assemblers, linkers and other language tools. These include all MPLAB C compilers; all MPLAB assemblers (including MPASM assembler); all MPLAB linkers (including MPLINK object linker); and all MPLAB librarians (including MPLIB object librarian).
- **Emulators** – The latest information on Microchip in-circuit emulators. This includes the MPLAB REAL ICE and MPLAB ICE 2000 in-circuit emulators.
- **In-Circuit Debuggers** – The latest information on the Microchip in-circuit debuggers. This includes MPLAB ICD 3 in-circuit debuggers and PICkit 3 debug express.
- **MPLAB IDE** – The latest information on Microchip MPLAB IDE, the Windows Integrated Development Environment for development systems tools. This list is focused on the MPLAB IDE, MPLAB IDE Project Manager, MPLAB Editor and MPLAB SIM simulator, as well as general editing and debugging features.
- **Programmers** – The latest information on Microchip programmers. These include production programmers such as MPLAB REAL ICE in-circuit emulator, MPLAB ICD 3 in-circuit debugger and MPLAB PM3 device programmers. Also included are nonproduction development programmers such as PICSTART Plus and PIC-kit 2 and 3.

CUSTOMER SUPPORT

Users of Microchip products can receive assistance through several channels:

- Distributor or Representative
- Local Sales Office
- Field Application Engineer (FAE)
- Technical Support

Customers should contact their distributor, representative or field application engineer (FAE) for support. Local sales offices are also available to help customers. A listing of sales offices and locations is included in the back of this document.

Technical support is available through the web site at:

<http://www.microchip.com/support>

DOCUMENT REVISION HISTORY

Revision	Correction
DS50002322C (07-02-15)	<ul style="list-style-type: none">• Added section 3.2 “Calibrating Sensors”• Added section 3.5.2 “Flash Configuration Update” feature• Added Appendix C “Extension Cable” info• Updated all pictures with latest production MM7150-PICTAIL• Updated all figures for sample code v1.3.3
DS50002322B (02-18-15)	<ul style="list-style-type: none">• Added section 3.4 for Sleep/Wake feature• Added section 3.5 for Flash Update feature, update corresponding sections• Changed UART baud rate from custom 125000 to standard 19200• Updated all the figures to show the v1.3.2 sample code• Updated the correct Document Numbers in the Reference Section• Added section 1.1 for hardware requirements• Added section 2.1 for software/firmware requirements• Section 3.2 “Calibrating Sensors” removed
DS50002322A (11-07-14)	Initial Release

Chapter 1. Hardware Setup

1.1 HARDWARE REQUIREMENTS

- Microchip Explorer 16 Development Board
- Microchip MM7150-PICtail Motion Module PICtail Board
- Microchip PICKit3 or ICD3 or RealICE debugger
- Null-Modem Serial Cable
- USB-to-Serial Adapter

1.2 PREPARING THE EXPLORER 16 DEVELOPMENT BOARD

- Insert PIM PIC24FJ128GA010 at Explorer 16 U1A socket
- Insert strap J7 for PIC24
- S2 switch selected for *PIM*
- Connect MPLAB ICD3 (or REAL ICE) In-Circuit Debugger module from HOST PC to JP1
- Connect USB-to-Serial Adapter capable of 19200 baud rate from HOST USB Port to Explorer 16 P1
 - *USB-to-Serial Adapter such as Microchip MCP2200 USB to RS232 Demo Board (Microchip part#: MCP2200EV-VCP)*

Note: Configure Terminal Emulation Software (ex. Tera Term) for 19200 baud, 8 bits, No Parity, 1 Stop Bit, No Flow Control.

- Power Supply (+9V) at J12

1.3 HARDWARE CONNECTIONS FOR MM7150-PICTAIL TO EXPLORER 16 DEVELOPMENT BOARD

Note: Before attempting to connect the MM7150-PICTAIL with PICtail™ Plus Edge connector module to the Explorer 16 board, it is crucial that the power supply to the Explorer 16 be disconnected. Failure to do so may damage the MM7150 Motion Module.

1.3.1 Direct Plug-In

The MM7150-PICTAIL can be installed directly into the Explorer 16 Board. Insert the MM7150-PICTAIL into the PICtail™ header J5 with pin 1 of the module lining up with pin 1 of the header, as seen in [Figure 1-1](#).

FIGURE 1-1: DIRECT CONNECTION OF MM7150-PICTAIL TO THE EXPLORER 16 PICTAIL™ HEADER.

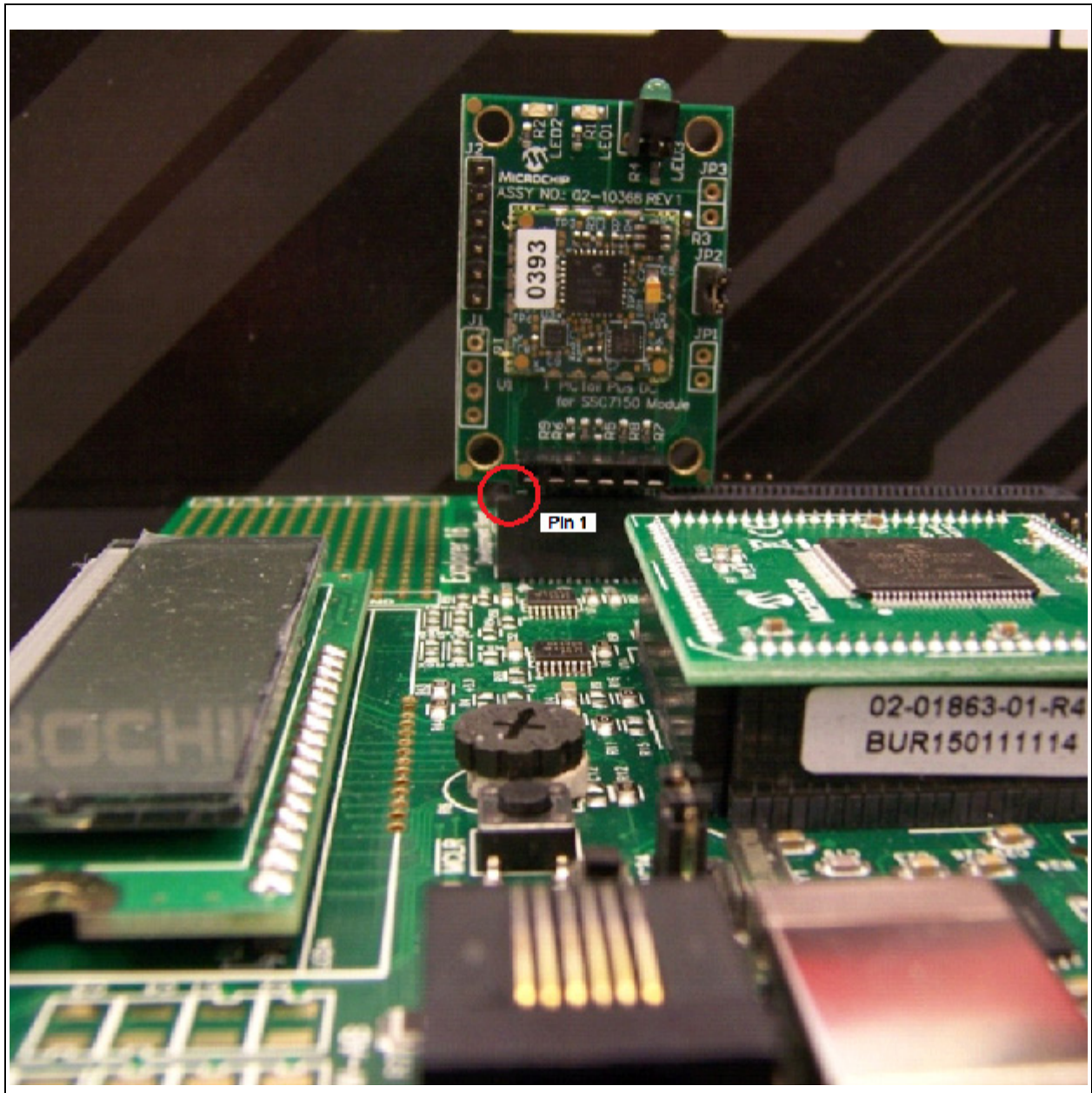

1.3.2 Using Extension Cable

The MM7150-PICTAIL motion module can be connected to the Explorer 16 development board via a custom extension cable. Using an extension cable will allow freedom of movement compared with directly inserting the MM7150-PICTAIL board into the PICTail header on the Explorer 16 board.

Please see [Appendix C. “Extension Cable for Explorer 16”](#) for more information.

Chapter 2. Software/Firmware Setup

2.1 SOFTWARE/FIRMWARE REQUIREMENTS

- Microchip MPLABX IDE v2.06 or later
- Microchip XC16 Compiler v1.24 or later
- MM7150_Exp16_Sample_Code_v1.3.3

Note: The latest sample code is available at www.microchip.com/motion or please contact your Microchip representative for more information.

- SSC7150 Motion Coprocessor Firmware Binary
 - The firmware can be updated using the flash update feature as described in [Section 3.5.1 “Flash Update command”](#).
 - The firmware binary object code is encrypted and the update process is secured.

Note: The latest firmware binary file is available at www.microchip.com/motion or please contact your Microchip representative for more information.

- MM7150 Module Configuration Firmware Binary
 - The configuration data can be updated using the update feature as described in [Section 3.5.2 “Flash Configuration Update Command”](#).

2.2 MPLABX PROJECT:

- Start MPLABX IDE as shown in [Figure 2-1](#).

FIGURE 2-1: MPLABX IDE STARTUP SCREEN



- File->Open Project Navigate to project directory and select *Open Project* as shown in [Figure 2-2](#).

FIGURE 2-2: OPEN PROJECT

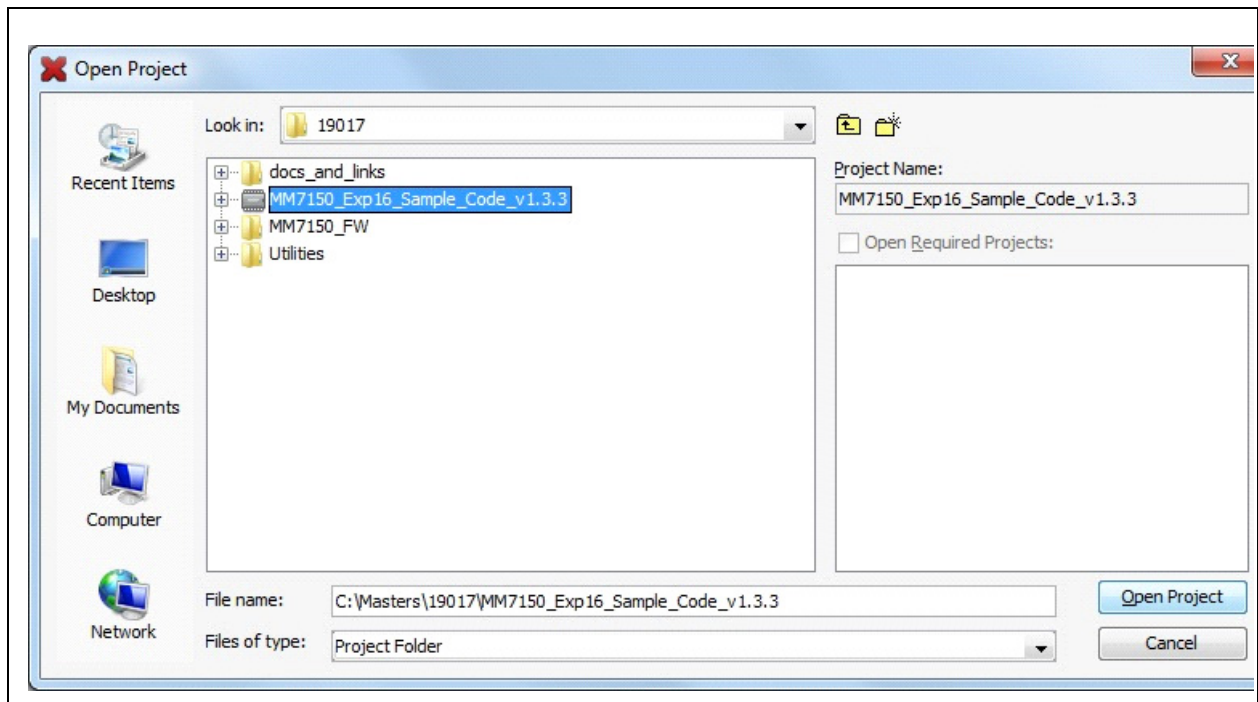

- Motion Demo Project Loaded as shown in [Figure 2-3](#):

FIGURE 2-3: PROJECT IS OPENED

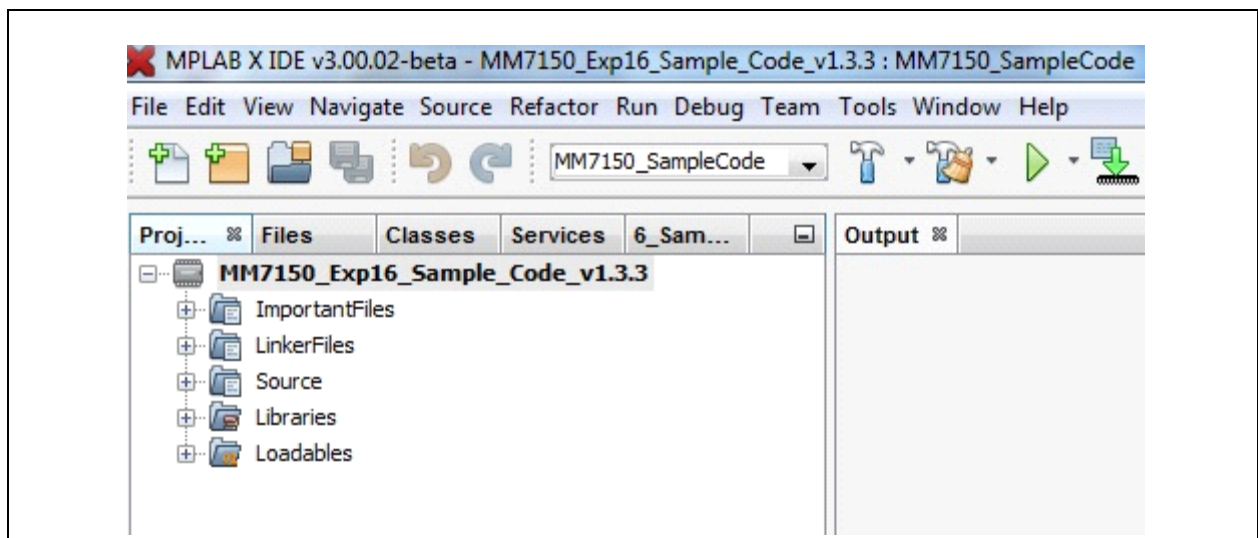

- With Explorer 16 power applied, make the project and download to Explorer 16 flash as shown in [Figure 2-4](#):

FIGURE 2-4: SELECT DOWNLOAD OPTION

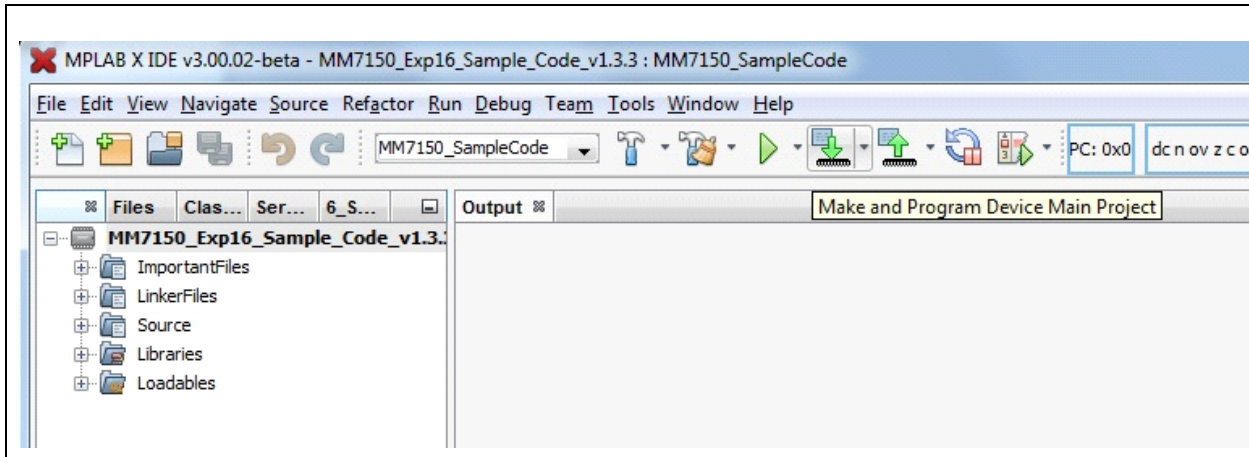

- Output screen during build process as shown in [Figure 2-5](#):

FIGURE 2-5: BUILD PROCESS OUTPUT

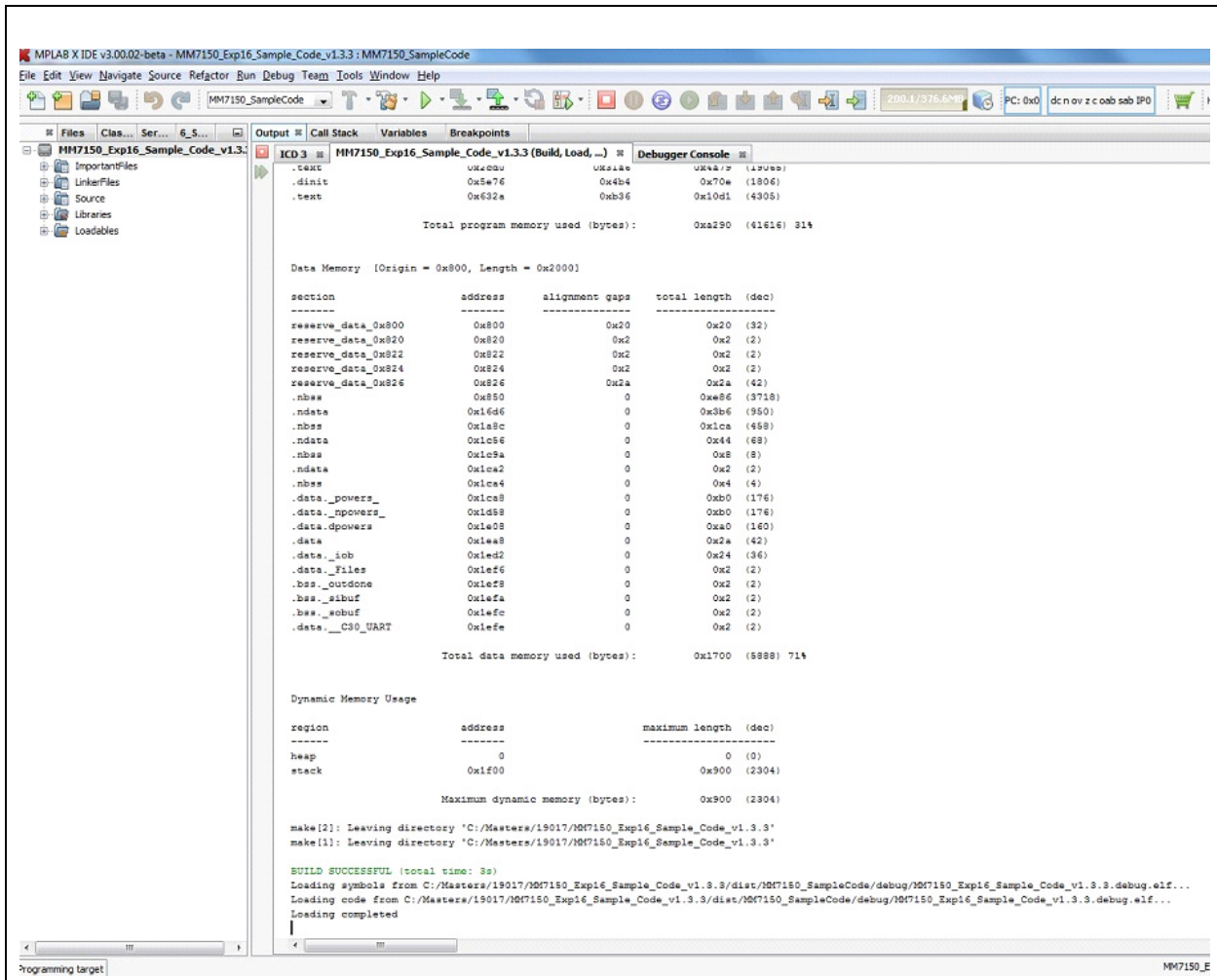

Chapter 3. Demo Setup

3.1 RUNNING THE MOTION DEMO

Note: Using a debugger will necessitate cycling power to the connected MM7150-PICTAIL to reset its onboard EC (embedded controller). The easiest way to accomplish this while debugging code is to remove/install power to the Explorer 16 Development board with the MM7150-PICTAIL installed in J5 header. DO NOT attempt to unplug the MM7150-PICTAIL while power is applied to it through its connection to the Explorer 16 Development board. This can cause a power spike to the MM7150-PICTAIL and cause it to become inoperative.

Once the program has been built and downloaded/programmed successfully to Explorer 16 Flash, the user should observe a sequence of LED flashes on the Explorer 16 board's LED panel.

The user should then observe the following message on the Explorer 16 board's LCD screen:

MM7150 Demo v133

Select mode:

Additionally the following message will appear in the serial terminal window on the connected computer:

Microchip Motion Module Demo: MM7150 + Explorer 16 Board v1.3.3

Select mode:

Once this message has been displayed, the user can begin navigating the user menu using the Explorer 16 push buttons (S3/S6/S5/S4). The buttons are coded as follows:

FIGURE 3-1: MM7150-PICTAIL ON EXP16 OVERVIEW

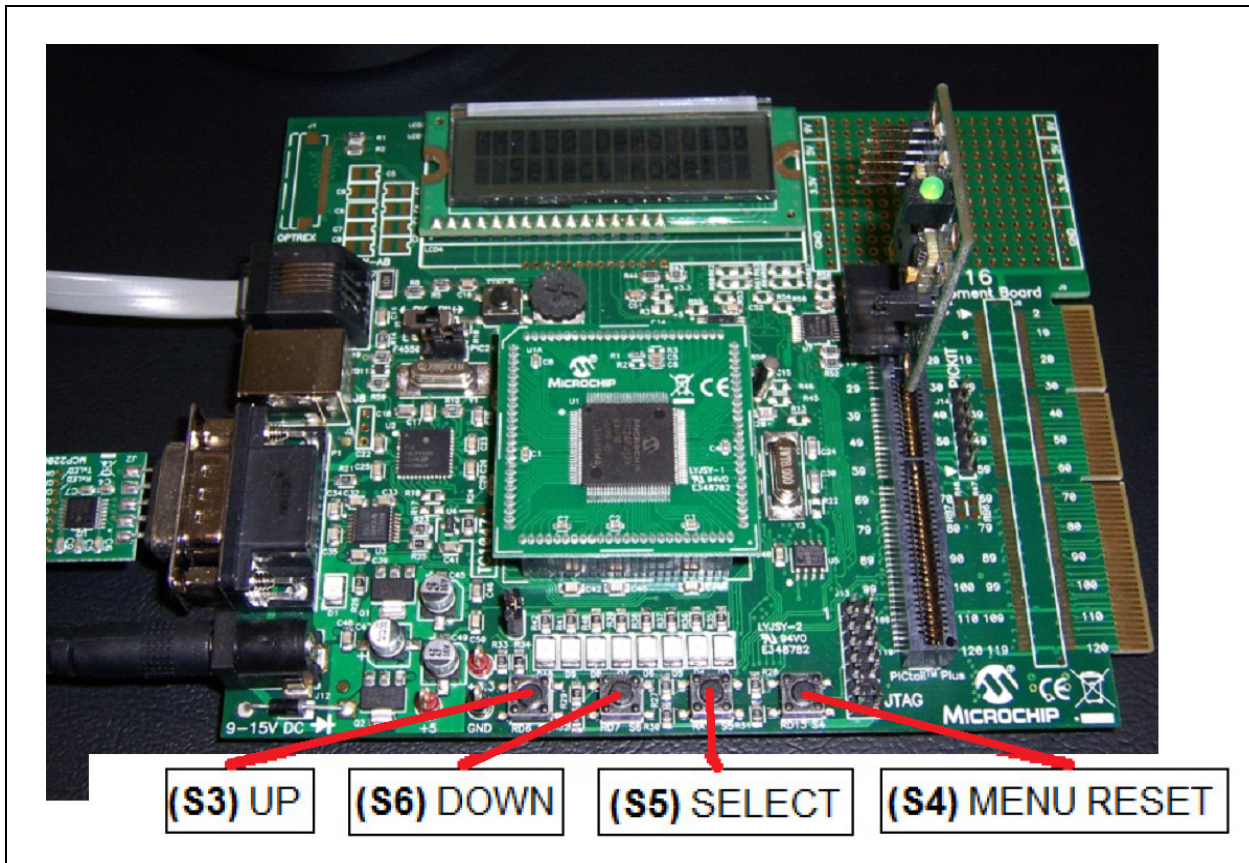

As the UP/DOWN buttons are pressed, the Explorer 16 LCD screen will refresh and change the position of the selection cursor (“>”) to a list of available sensor types. The output to the serial monitor will also change to indicate the current sensor type which can be selected by pressing the (S5) SELECT button. Once the user selects a sensor from the menu, the sensor data output will be displayed and updated on both the LCD and serial monitor.

3.2 CALIBRATING SENSORS

In order for the sensors to function properly and indicate accurate data the user will need to calibrate the MM7150 each time power has been removed. This calibration is done by selecting the “Calibration” mode as shown in [Figure 3-2](#), holding the MM7150-PICTAIL which is attached via an extension cable (see [Appendix C. “Extension Cable for Explorer 16”](#) for more information), or if not using an extension cable, by holding the entire Explorer 16 board with MM7150-PICTAIL installed, and moving it through space a few times (~ 5 seconds) to make an “infinity” symbol or a “figure 8”.

FIGURE 3-2: CALIBRATION MODE

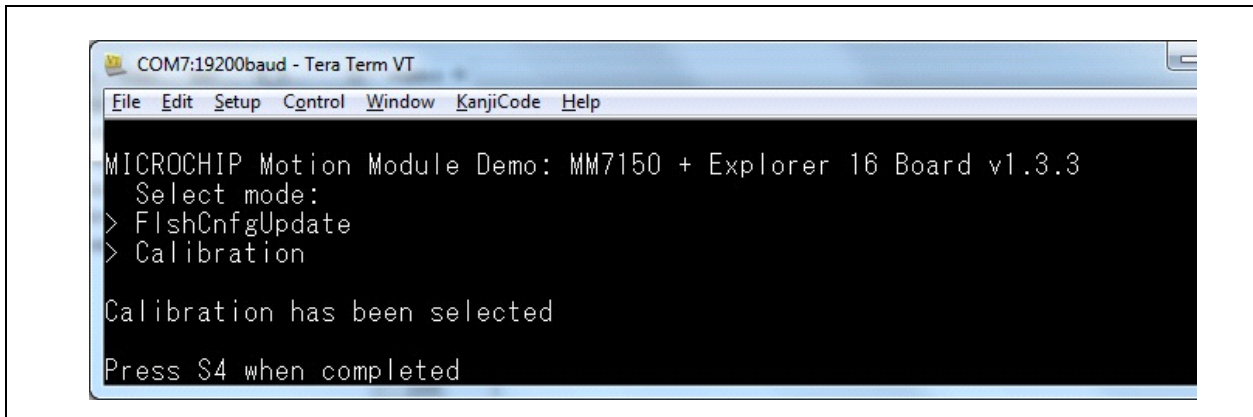

3.3 SENSOR DATA DISPLAY

Once calibrated the active sensors on the MM7150 motion module will send updates to the PIC24 on the Explorer 16 board running the application program via I²C in the form of HID packets including all relevant dimensions of data to be retrieved from the device. These sensor readings will be displayed on the LCD (as well as the COM port) in a 'linear' formatting):

1D data: 79.0
3D data: X: 50.3 Y: 75.6 Z: -32.9
4D data: X: 1.021 Y:-.642 Z:-.458 W: .348

Note: Significant digits will vary based on resolution of specific sensor. This resolution can be determined by the *unit exponent scaling factor*. Serial data will always be displayed to 3 significant digits.

Sample output to COM port running Tera Term serial emulator:

FIGURE 3-3: DISPLAY INCLINOMETER DATA

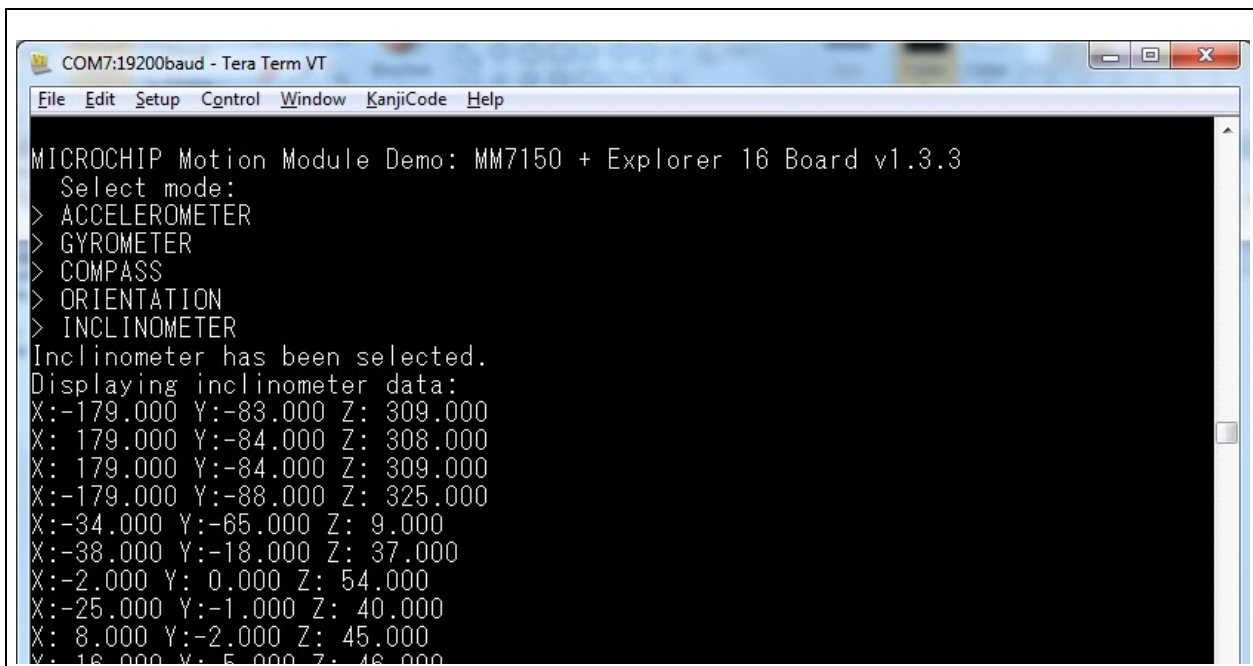

The sensor data is updated to the display every time a data register has changed since the previous update.

3.4 SLEEP/WAKE

The MM7150 motion module can be set to enter deep sleep to achieve its lowest power consumption. In the Explorer 16 sample code this can be accomplished by selecting the SLEEP command from the main menu. The Explorer 16 host will send a POWER_OFF command through the I²C interface. As a result of this SLEEP command the MM7150 motion coprocessor is halted and the I²C interface is stopped.

Select the WAKE command from the Explorer 16 main menu to wake the MM7150 motion module. This command will toggle the HOST_TO_SH_WAKE signal to alert the MM7150 to wake, send the POWER_ON command via I²C interface, and wait the required time to allow the MM7150 to fully wake and allow sensor activity to resume.

The sleep/wake process requires that certain timing constraints must be observed (shown below in [Figure 3-1](#)).

TABLE 3-1: SLEEP / WAKE TIMING CONSTRAINTS

		Delay period	Reason
1	Required delay between sending the SLEEP command & toggling WAKE	70ms	This is required for the coefficient write in flash during D3 plus other house-keeping activities to go into D3 state
2	Required delay between toggling (3 μs min) the wake signal and sending power ON command	11ms	This is required for clock source switching after coming out of D3 state
3	Required delay between D3 wake and enumeration sequence start	30ms	This is required for sensor initialization after D3 state

3.5 FLASH UPDATE

The MM7150 motion module firmware can be updated with the appropriate binary image (please refer to [Section 2.1 “Software/Firmware requirements”](#) for more information) by selecting Flash Update from the Explorer 16 main menu. The Explorer 16 sample code will reset the MM7150 module into a state able to accept the new binary image, download and CRC-check a valid binary image, program new MM7150 firmware binary via I²C interface, and finally perform image verification.

Note: The Explorer 16's UART connection will be used to download the flash update binary and, as such, must be connected to a HOST PC running a terminal emulator (such as *Tera Term* as described in [Section 1.2 “Preparing the Explorer 16 Development Board”](#)).

3.5.1 Flash Update command

Figure 3-4 shows the Flash Update Command from the Exp 16 sample code select menu.

FIGURE 3-4: FLASH UPDATE COMMAND

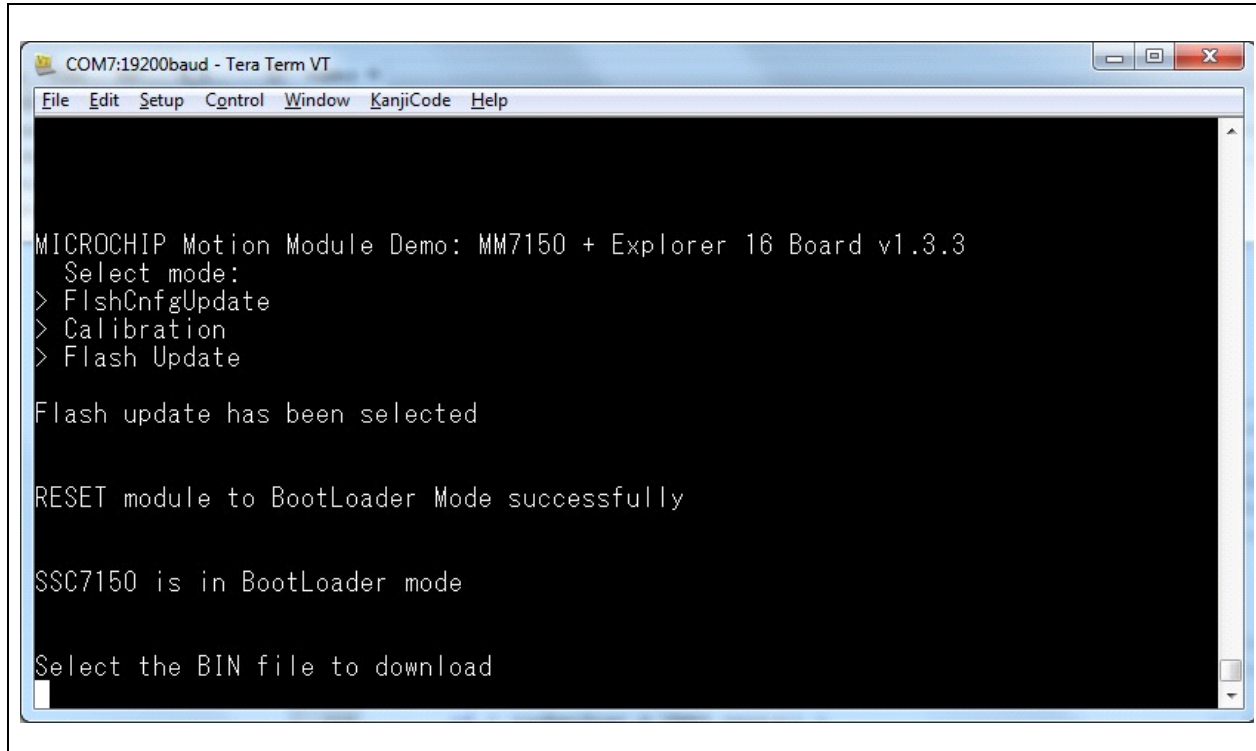

Select “File->Send file...” from Tera Term utility (NOTE: Select *Binary Option*).

FIGURE 3-5: SELECT BINARY FILE

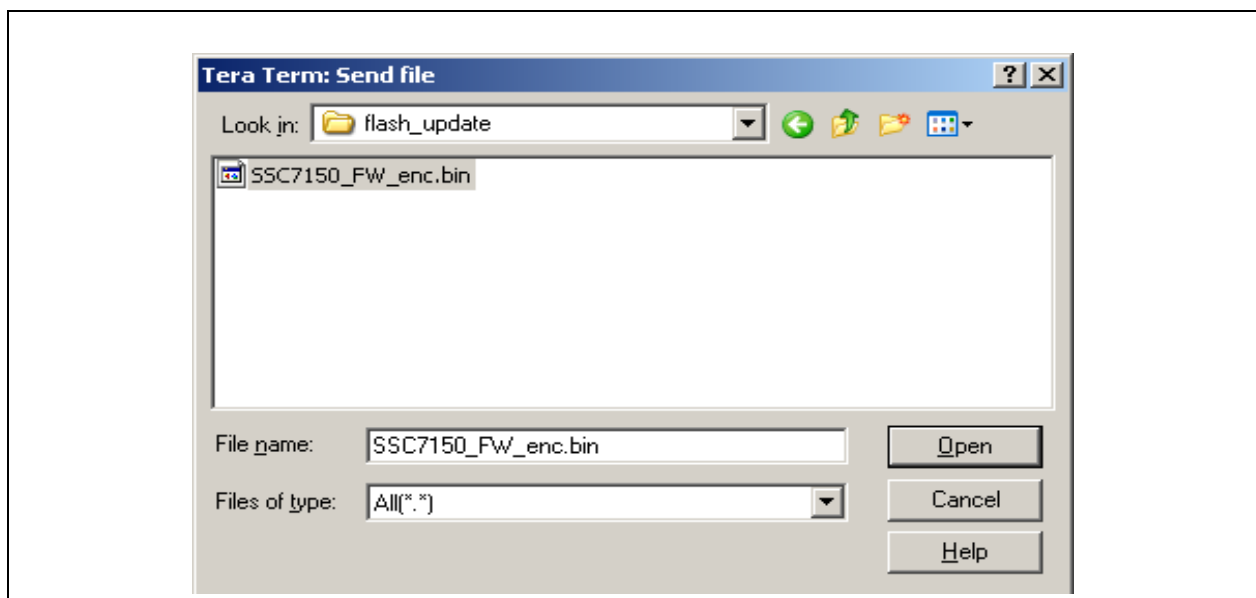

FIGURE 3-6: DOWNLOADING BINARY IMAGE

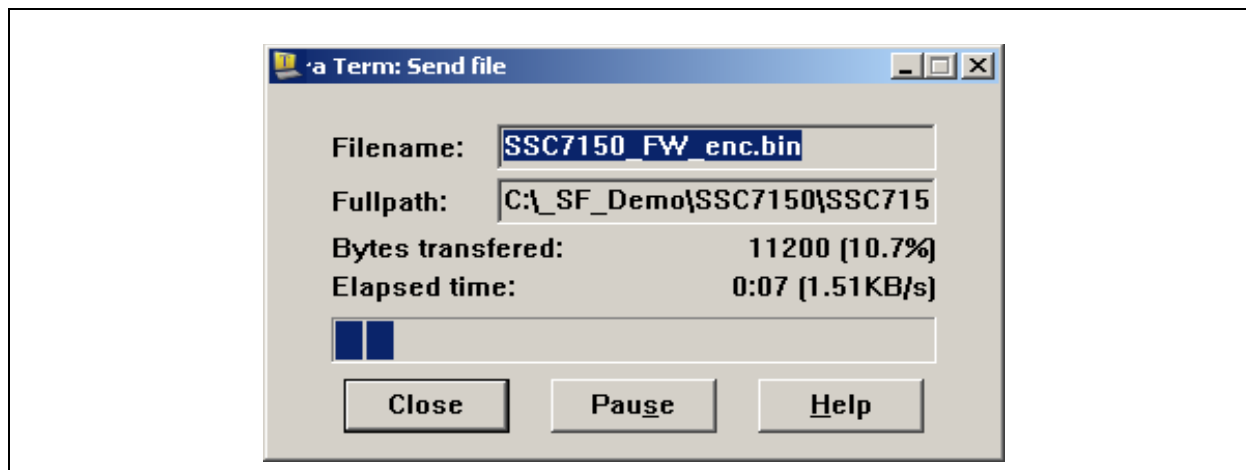
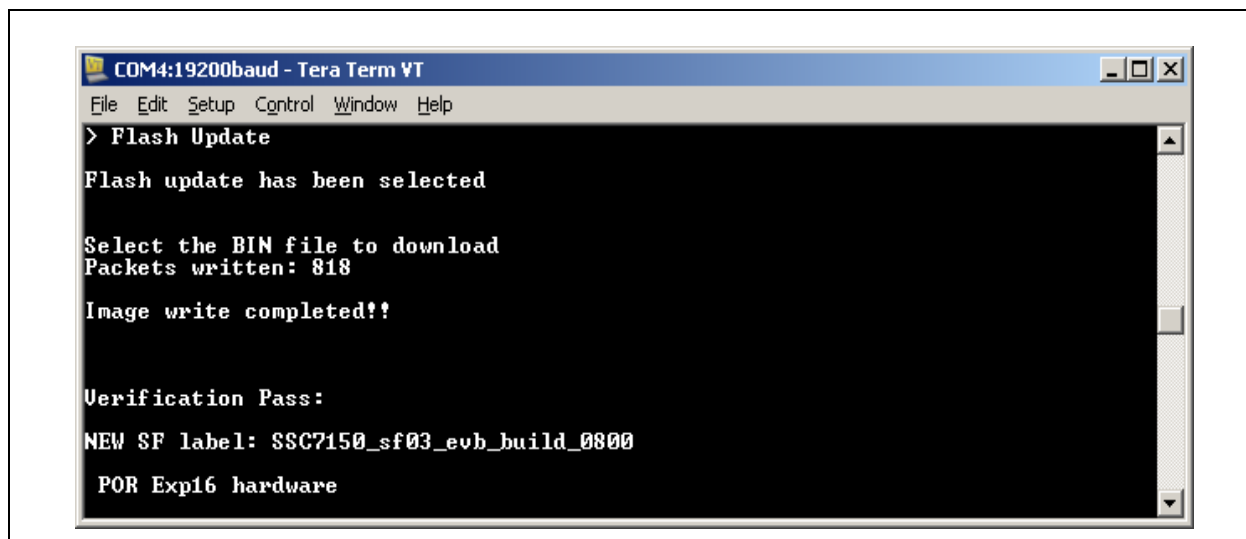

FIGURE 3-7: FLASH UPDATE SUCCESSFUL COMPLETION



Following successful completion of the flash update procedure (or if any error is encountered), the Explorer 16 must be power cycled.

3.5.2 Flash Configuration Update Command

The X/Y/Z orientation of the MM7150 module on the customer's design can be modified and saved to the MM7150's flash. The default orientation of the A/M/G sensors of MM7150 (placed horizontally) is:

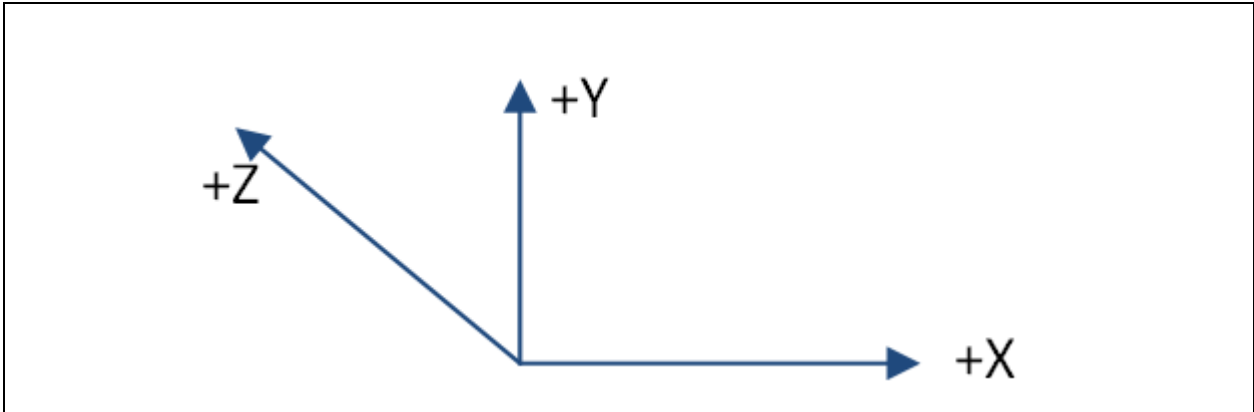

For this case, the inputs to the motion algorithm (running in MM7150 firmware) can be represented by the following 3x3 matrix (Accelerometer for example):

Matrix[3, 3] = [A00, A01, A02; A10, A11, A12; A20, A21, A22];

where A_{xx} could be 0, 1, or -1.

So, for the horizontal orientation shown above and assuming that X/Y/Z are data read from the hardware sensor and X'/Y'/Z' are data input to the motion algorithm:

$$X' = A00*x + A01*y + A02*z$$

$$Y' = A10*x + A11*y + A12*z$$

$$Z' = A20*x + A21*y + A22*z$$

Since the input matrix corresponds one to one in X/Y/Z to the output matrix, we obtain the following:

$$X' = 1*x + 0*y + 0*z$$

$$Y' = 0*x + 1*y + 0*z$$

$$Z' = 0*x + 0*y + 1*z$$

i.e. Resulting matrix[3, 3] = [1,0,0; 0,1,0; 0,0,1;]

This orientation configuration data must be sent to the appropriate sector in the MM7150 firmware in the following format:

TABLE 3-2: CONFIGURATION DATA FORMAT FOR HORIZONTAL

Name	Values
Header	A5A5A5A5
Serial_num	00000000
ACC_matrix	010000000100000001
MAG_matrix	010000000100000001
GYR_matrix	010000000100000001
Reserved	00
ACC_config	01010110
MAG_config	02010112
GYR_config	03010168
Reserved	04010144
Reserved	05010177
Reserved	06000000
Reserved	07000000
Reserved	08000000
Reserved	09000000
Reserved	0A000000
Chk_sum	23040000 (see Note 1)
Padded	FF's for 128 byte packet

Note 1: Check sum will be calculated by the sample code flash configuration update command, as a result this field will be ignored and can be: 00000000.

For example, the XYZ matrix result for the accelerometer (acc_matrix) takes the form of:

ACC_matrix = 01 00 00 (X=1,0,0) 00 01 00 (Y=0,1,0) 00 00 01 (Z=0,0,1)

For MM7150_Exp16_Sample_Code_v1.3.3, the flash configuration data needs to be in the following *binary* file format (derived from the above text file):

FIGURE 3-8: CONFIGURATION DATA BINARY FOR HORIZONTAL

```

HORIZ_CONFIG.BIN
00000000  A5 A5 A5 A5 00 00 00 00 01 00 00 00 01 00 00 00
00000010  01 01 00 00 00 01 00 00 00 01 01 00 00 00 01 00
00000020  00 00 01 00 01 01 01 10 02 01 01 12 03 01 01 68
00000030  04 01 01 44 05 01 01 77 06 00 00 00 07 00 00 00
00000040  08 00 00 00 09 00 00 00 0A 00 00 00 23 04 00 00
00000050  FF FF FF FF FF FF FF FF FF FF FF FF FF FF FF
00000060  FF FF FF FF FF FF FF FF FF FF FF FF FF FF FF
00000070  FF FF FF FF FF FF FF FF FF FF FF FF FF FF FF
.....

```

Similarly, for the A/M/G sensors of the MM7150 placed vertically (such as when plugged into the Explorer 16 card):

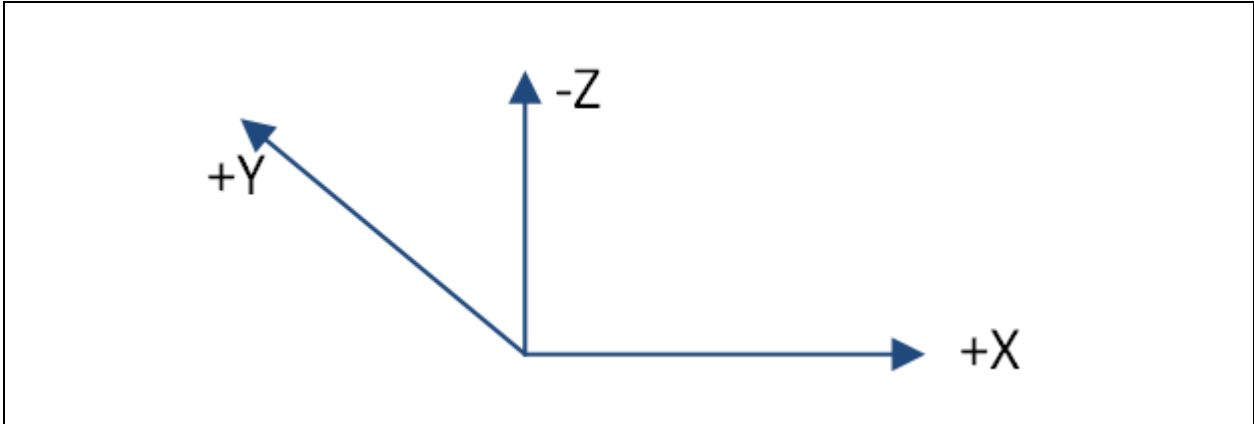

For the vertical orientation shown above and assuming that X/Y/Z are data read from the hardware sensor and X'/Y'/Z' are data input to the motion algorithm with respect to the default X/Y/Z settings:

$$X' = A00*x + A01*y + A02*z$$

$$Y' = A10*x + A11*y + A12*z$$

$$Z' = A20*x + A21*y + A22*z$$

Since, for this case, the input matrix does not correspond one to one in X/Y/Z to the output matrix, we obtain the following translations:

$$X' = 1*x + 0*y + 0*z$$

$$Y' = 0*x + 0*y - 1*z$$

$$Z' = 0*x + 1*y + 0*z$$

i.e. Resulting matrix[3, 3] = [1,0,0; 0,0,-1; 0,1,0;]

This vertical configuration data can be sent to the appropriate sector in the MM7150 firmware in the following format:

TABLE 3-3: CONFIGURATION DATA FORMAT FOR VERTICAL

Name	Values
Header	A5A5A5A5
Serial_num	00000000
ACC_matrix	0100000000FF000100
MAG_matrix	0100000000FF000100
GYR_matrix	0100000000FF000100
Reserved	00
ACC_config	01010110
MAG_config	02010112
GYR_config	03010168
Reserved	04010144
Reserved	05010177
Reserved	06000000
Reserved	07000000
Reserved	08000000
Reserved	09000000
Reserved	0A000000
Chk_sum	1D070000 (see Note 1)
Padded	FF's for 128 byte package

For MM7150_Exp16_Sample_Code_v1.3.3 the flash configuration data must adhere to the following *binary* file format:

FIGURE 3-9: CONFIGURATION DATA BINARY FOR VERTICAL

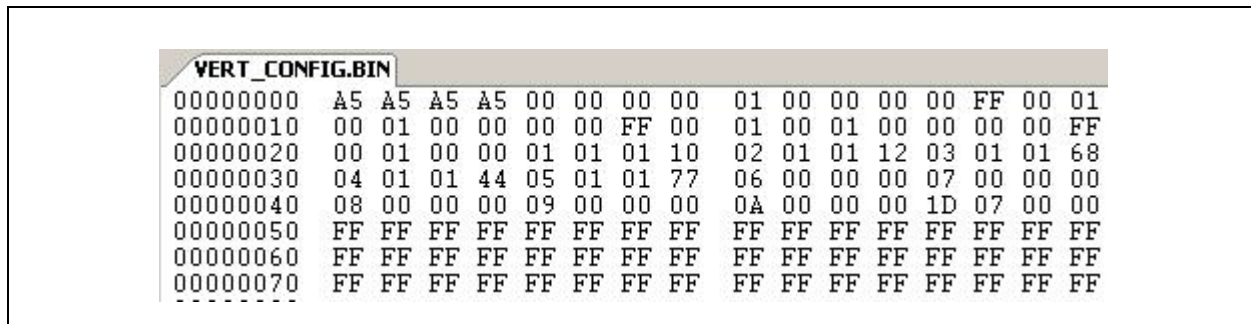

Using the sample code's Flash Configuration Update mode:

FIGURE 3-10: FLASH CONFIGURATION DATA MODE

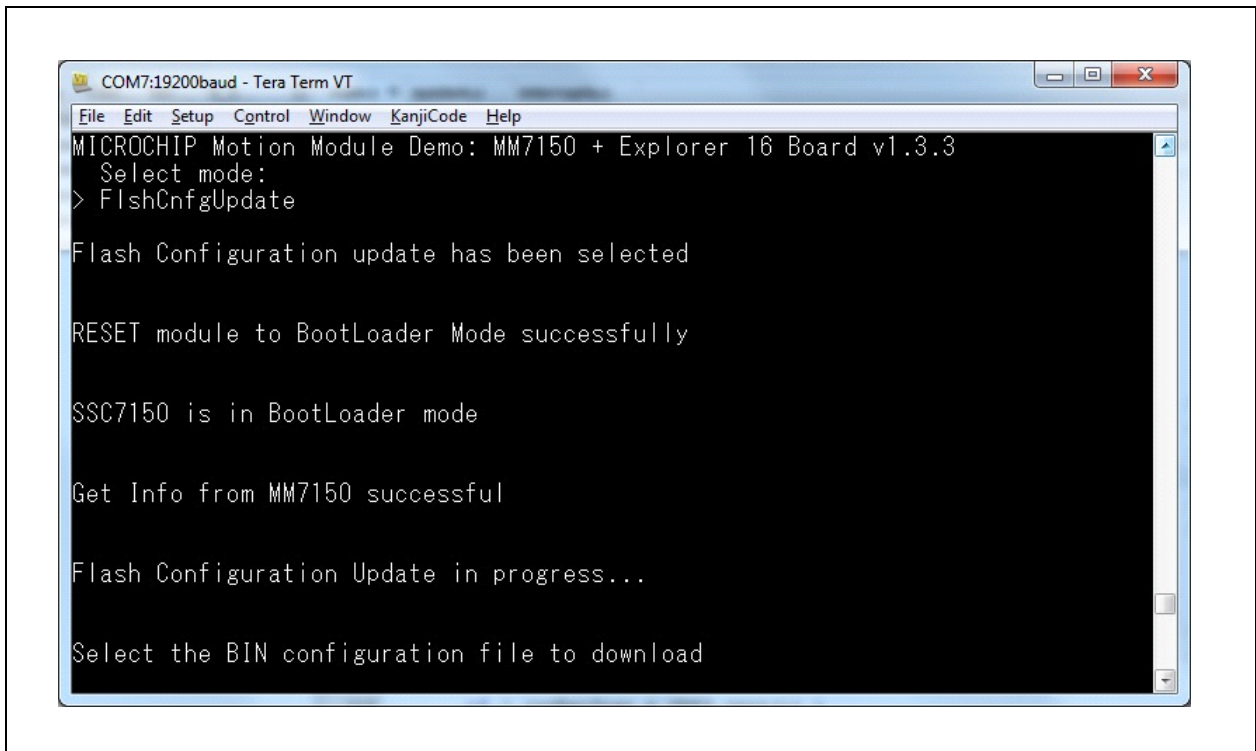

Select "File->Send file..." from TeraTerm utility: (NOTE: Select *Binary Option*).

FIGURE 3-11: SELECT BINARY FILE

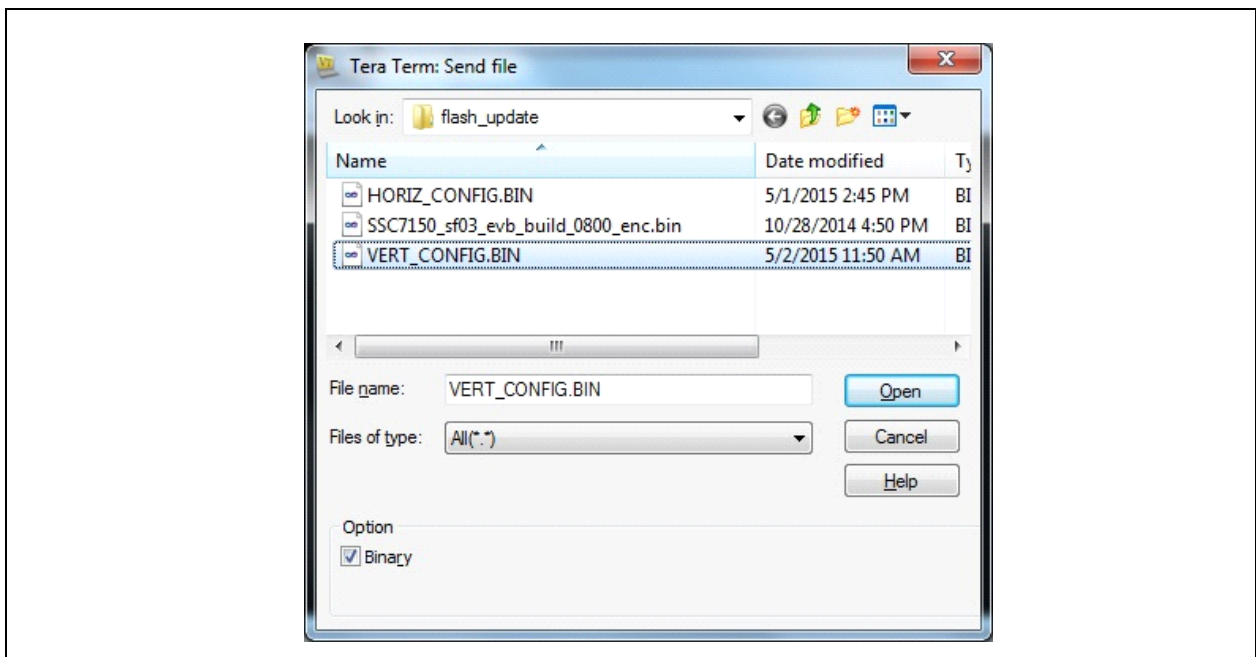

Select "Open" to download binary file to flash.

Following successful completion of the flash configuration update procedure (or if *any* error is encountered), the Explorer 16 must be power cycled (POR).

Note: Should an issue arise due to incorrect formatting of binary data, the MM7150 Flash can be restored using the Flash Update command in [Section 3.5.1 "Flash Update command"](#).

FIGURE 3-12: FLASH CONFIGURATION UPDATE SUCCESSFUL

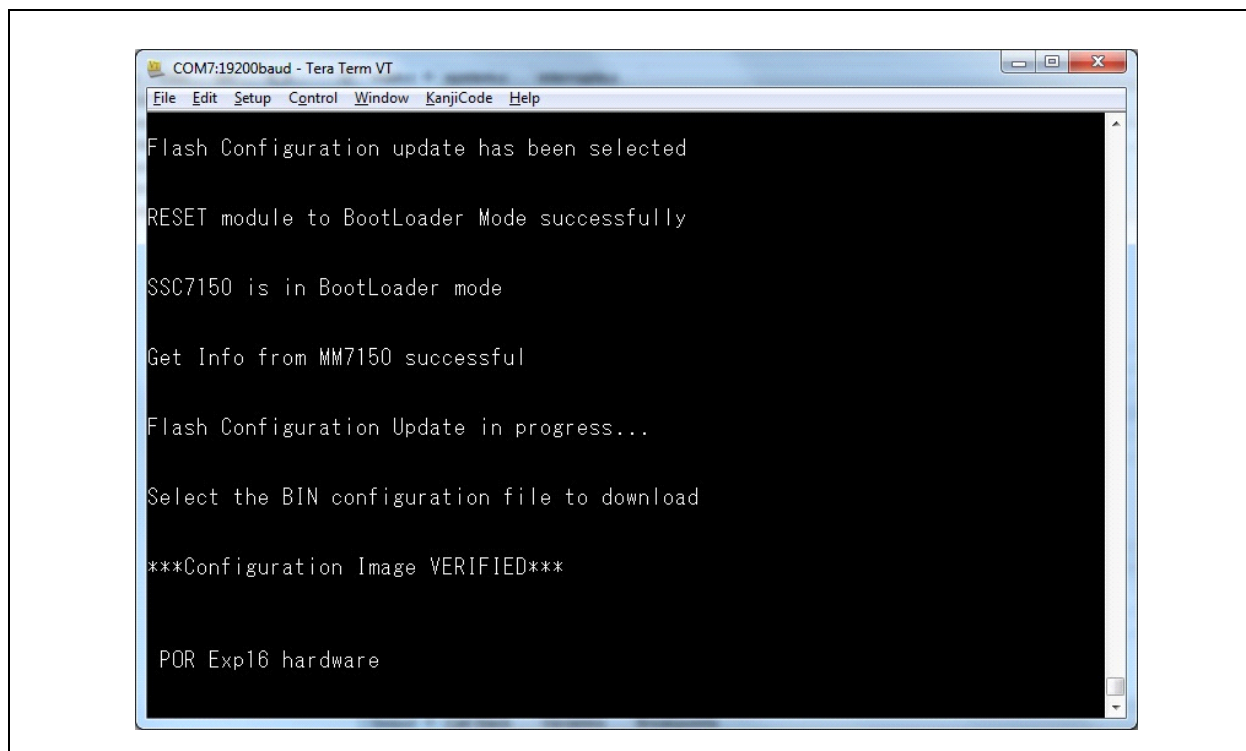

Chapter 4. Troubleshooting

This chapter describes troubleshooting potential issues and fixes.

4.1 FAILURE TO DISPLAY WELCOME SCREEN

If the welcome message fails to display on the Explorer 16 LCD screen and error messages depicted below appear in the debugger's output (using Microchip ICD3 or REAL ICE debugger for instance), the most likely cause is a failure to disconnect and reconnect power to the MM7150-PICTAIL. This is accomplished by disconnecting and reconnecting power to the Explorer 16 board before restarting the demo. This process serves as a 'hard reset' for the SSC7150 on the MM7150-PICTAIL, allowing I²C communication to reinitialize and restart.

FIGURE 4-1: ERROR MESSAGE IN DEBUGGER'S TAB

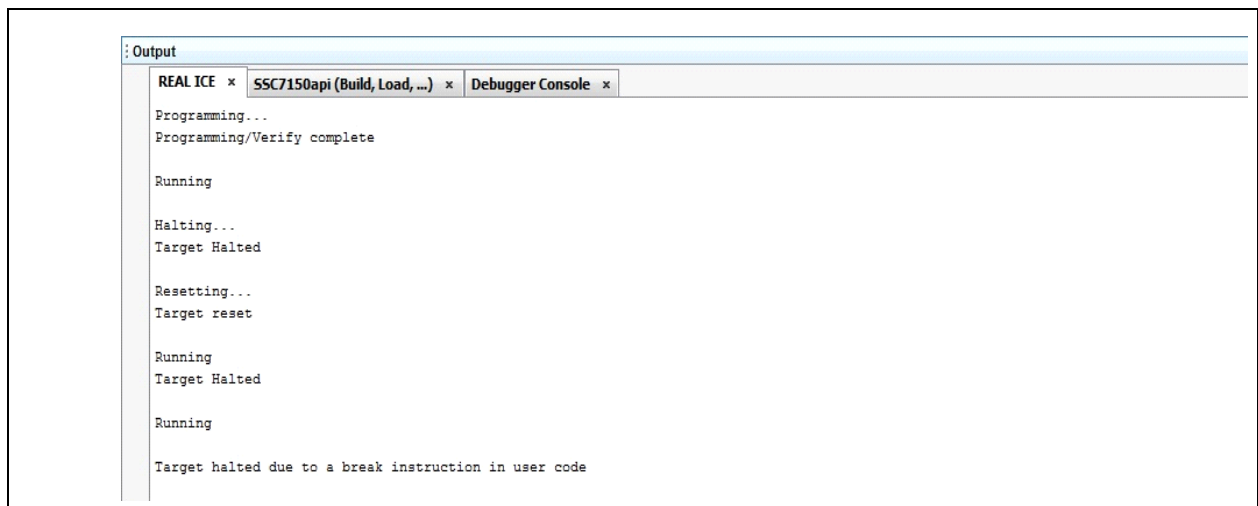

Note: If user is running on a different debugger (eg: ICD3, Real ICE etc.) the message would appear in that debugger's output tab.

FIGURE 4-2: ERROR MESSAGE IN DEBUGGER CONSOLE TAB.

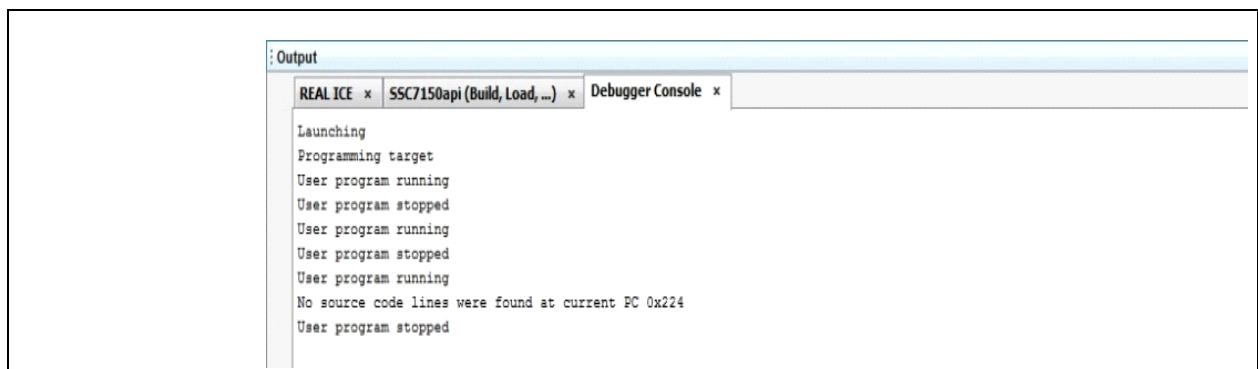

4.2 ERROR HANDLING

4.2.1 General Error Handling for VREG Functions

Note: Please refer to “DS00001873A - Host API Design for MM7150-PICTAIL Motion Module Application Note” for more information regarding virtual registers (VREG) defined and used in the sample code.

VREG functions which fail to complete due to certain hardware events may display error information via error handling output on the Explorer 16 board's LCD screen and on the serial terminal window on the connected computer.

For example, in the case of a VREG *Read* operation of *register 16h* which encounters a problem while reading data in response to receiving a *HIDI2C_HOST_INT* (which indicates that a MM7150 sensor has data available) the following will be displayed on the Explorer 16 board's LCD:

```
VRRd:16 err=0x31
Push S5 to cont
```

where:

VRRd:16 - Attempting a VREG Read operation on register 16h (VREG ACXD register)

err=0x31 – Error code generated (see *error code definitions* in [Section 4.2.3](#))

Push S5 to cont - Press button S5 to attempt to recover from the reported error

The same error is displayed on the serial terminal window on the connected computer:

FIGURE 4-3: SERIAL TERMINAL GENERAL ERROR HANDLING DISPLAY

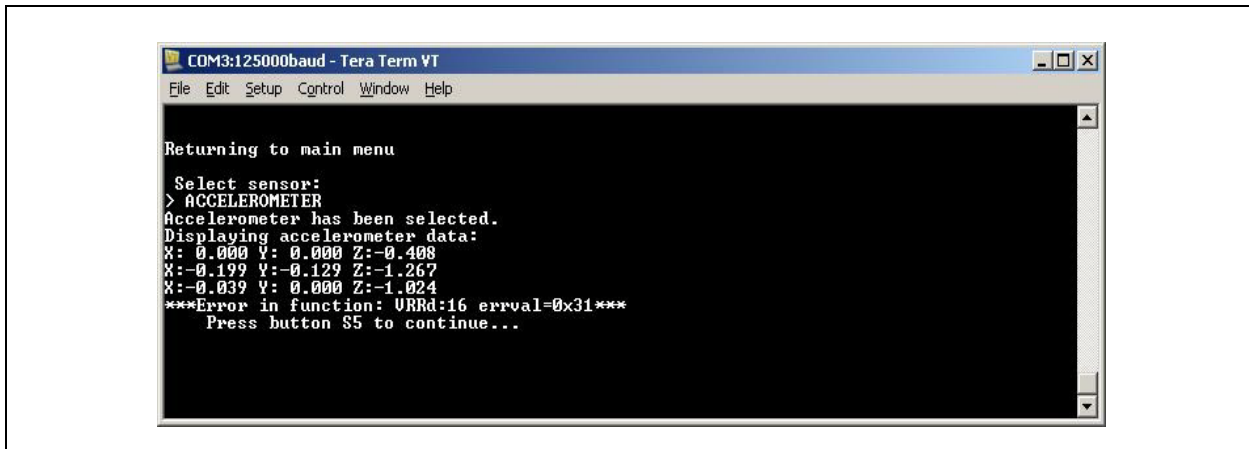

TABLE 4-1: GENERAL ERROR HANDLER FUNCTION ABBREVIATION

Function	Error Handler Output Abbreviation
VREG_init()	Vini
HOST_SF_LIB_VREG_read()	VRRd
HOST_SF_LIB_VREG_write ()	VRWr
I2cIO()	i2c

4.2.2 I²C Error Handling

Upper level functions which employ I²C function calls for the Explorer 16 board's PIC24 to MM7150 interface that fail to complete will display error information. The I²C error handling display is output on the Explorer 16 board's LCD screen and on the serial terminal window on the connected computer.

Note: Most, if not all, I²C errors are hardware dependent. As this sample code is specific to the PIC24 on the Explorer 16 board, I²C errors are simply flagged as an error to illustrate where the issue was encountered. For this demo, in the rare event that a fully functional I²C interface encounters an error, the error "recovery" method will require resetting the Explorer 16 board and, hence, the connected MM7150-PICTAIL.

For example, in the case of an i2cIO operation which encounters an issue, wherein the MM7150 fails to ACK properly, the following will be displayed on the Explorer 16 board's LCD:

```
i2c  error=0x29
POR Exp16 Board
```

where:

i2c - error occurred in i2cIO() function

error=0x29 – error code generated (see error code definitions in [Section 4.2.3](#))

POR Exp16 Board - Power On Reset Explorer 16 board (and connected MM7150-PICTAIL)

The same error is displayed on the serial terminal window on the connected computer:

FIGURE 4-4: SERIAL TERMINAL I²C ERROR HANDLING DISPLAY

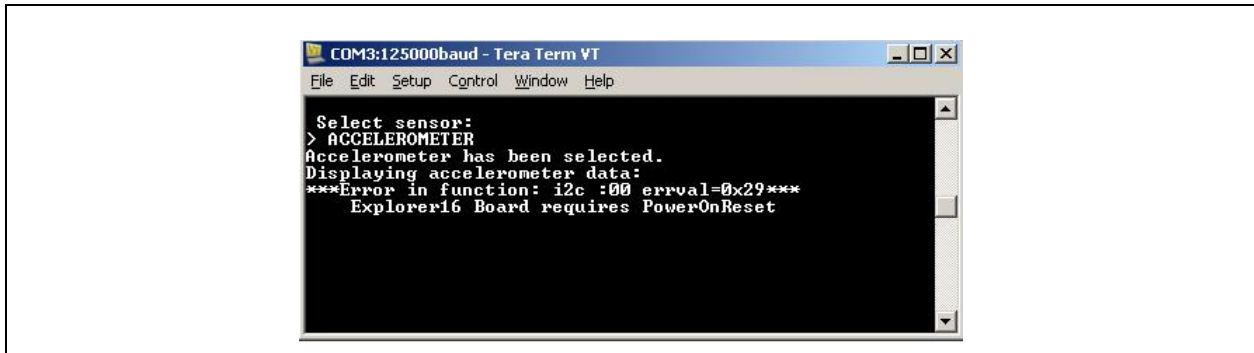

4.2.3 Error Definitions (from source/headers/err.h)

Error Value	Definition	Module/Type
0	SUCCESS	
10h	ID_FAIL	sf.c
11h	HID_DESC_FAIL	sf.c
12h	RPT_DESC_FAIL	sf.c
14h	REP_PARS_FAIL	sf.c
15h	NO_EOC_FAIL	sf.c
16h	GET_FEAT_FAIL	sf.c
17h	SET_FEAT_FAIL	sf.c
18h	RESET_FAIL	sf.c
19h	SET_RPT_FAIL	sf.c
1Ah	POWER_ON_FAIL	sf.c
1Bh	SLEEP_CMD_FAIL	sf.c
1Ch	HID_GET_RPT_INPT_FAIL	sf.c
1Dh	HID_GET_RPT_FEAT_FAIL	sf.c
1Eh	WAKE_CMD_FAIL	sf.c
21h	I2C_ERROR	i2cIO.c
22h	I2C_BUF_OVERFLOW	i2cIO.c
23h	WRITE_COLL	i2cIO.c
24h	NOT_ACK	i2cIO.c
25h	BUS_COLL	i2cIO.c
26h	RX_OVFLO	i2cIO.c
27h	HID_DESC_RET	i2cIO.c
28h	REP_DESC_RET	i2cIO.c
29h	I2C_TIMEOUT_ERR	i2cio.c
31h	HID_INT_FAIL	vregs.c
32h	VREG_ACCESS_ERR	vregs.c
33h	VREG_OFFSET_ERR	vregs.c
41h	FLSH_INFO_ERR	flash_update.c
42h	FLSH_WRITE_ERR	flash_update.c
43h	FLSH_VERIFY_ERR	flash_update.c
44h	FLSH_CRC_ERR	flash_update.c

Appendix A. Code Structure

A.1 DIRECTORY STRUCTURE

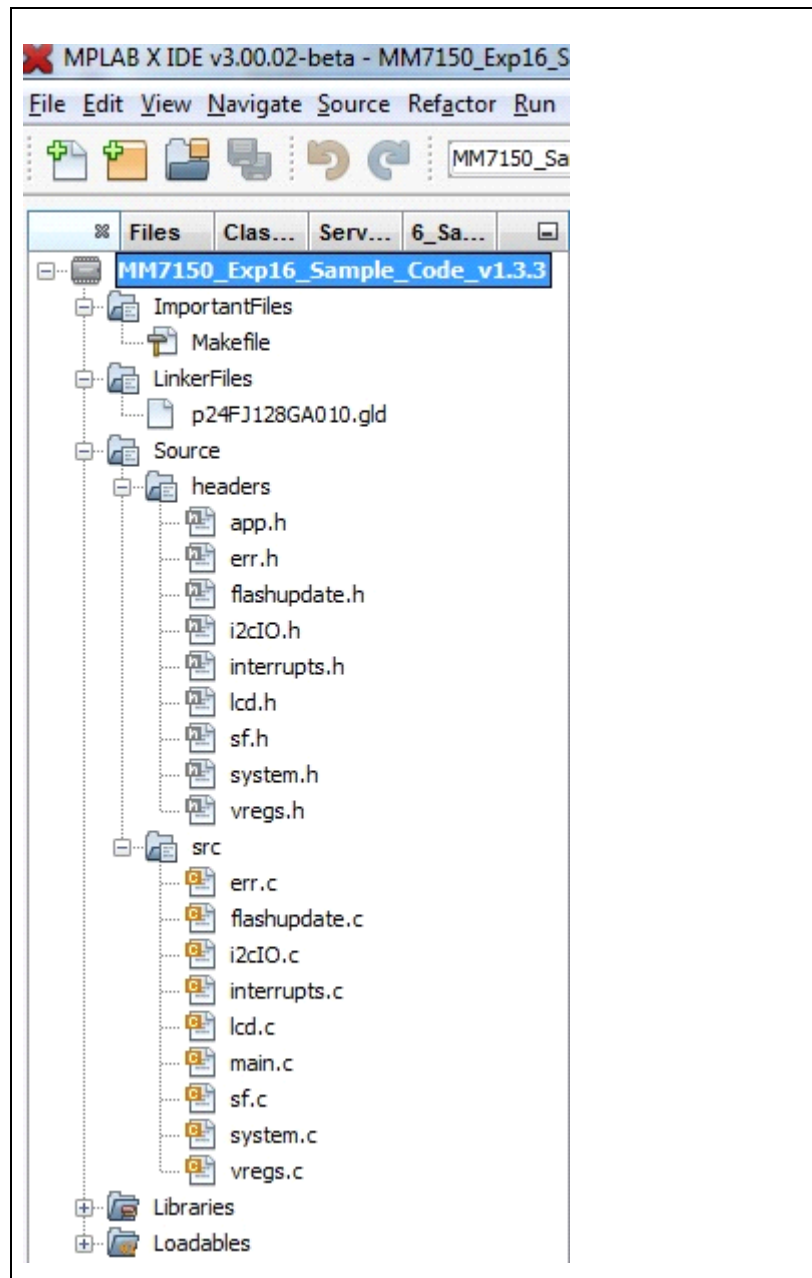

TABLE A-1: DIRECTORY STRUCTURE OF THE SENSOR FUSION SAMPLE CODE

Files	Description
\\source\\headers\\app.h	Include for all other underlying h files and typedefs
\\source\\headers\\err.h	Functions and parameters for error handling
\\source\\headers\\flash_update.h	Functions for flash update
\\source\\headers\\i2cIO.h	Functions and parameters specific to I ² C communication with MM7150 module
\\source\\headers\\interrupts.h	Interrupt functions
\\source\\headers\\lcd.h	Functions relevant to LCD operation
\\source\\headers\\sf.h	Functions relevant to decoding and encoding HID commands and packets
\\source\\headers\\system.h	Functions relevant to running the demo
\\source\\headers\\vregs.h	Functions relevant to the creation of the virtual register layer of the MM7150 API library
\\source\\src\\err.c	Error handling functions for I ² C and VREG operations
\\source\\src\\flash_update.c	Functions for flash update.
\\source\\src\\i2cIO.c	Functions to communicate with MM7150 Module via I ² C
\\source\\src\\interrupts.c	Interrupt initialization and handler for INT1 (from EC-Host-interrupt), T2 (timer2 interrupt), and CN (change notification interrupt from buttons)
\\source\\src\\lcd.c	LCD support for Explorer 16 board
\\source\\src\\main.c	Functions to setup Explorer 16 board environment, COM port UART2, interrupts, timers, I ² C, HID_initialization, start HID handshaking with EC via I ² C commands
\\source\\src\\sf.c	Functions to get HID tables from MM7150 Module, send power and reset HID commands, get HID report descriptors, parse descriptors, get input from sensor devices
\\source\\src\\system.c	Initiates the motion demo by configuring LED's, LCD, Serial, and buttons
\\source\\src\\vregs.c	Mediator between HID-I ² C communication and user Commands (interactive layer of API)

A.2 PROGRAM FLOW

A.2.1 Main.c

FIGURE A-1: PROGRAM FLOW CHART

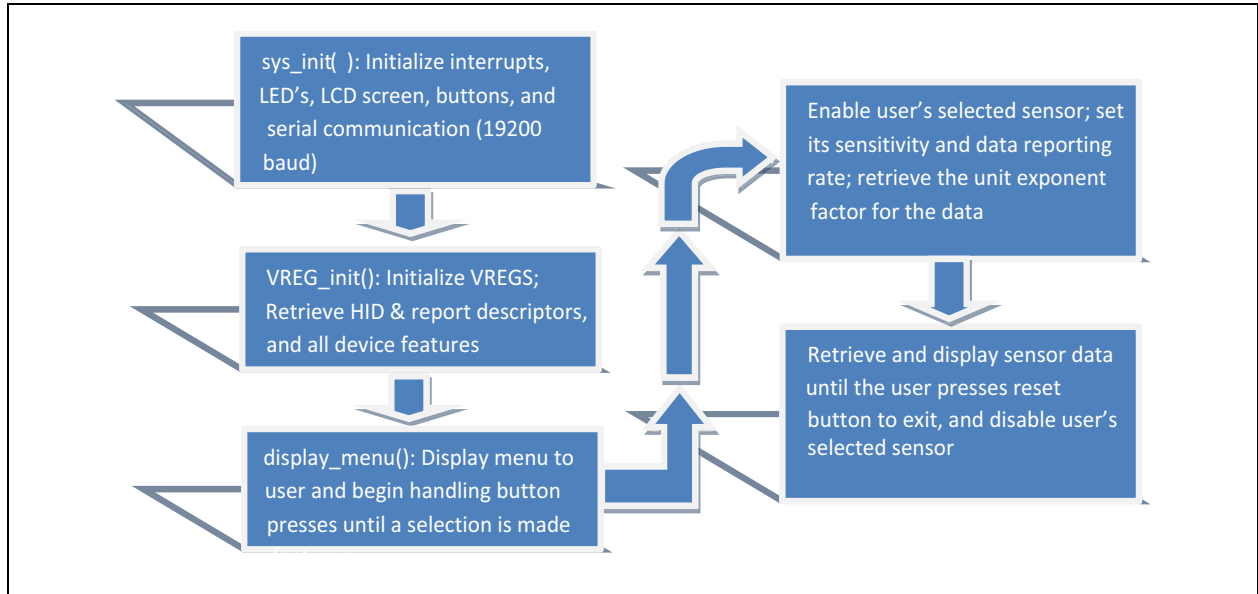

A.2.2 Configuring and Initializing MM7150 Motion Module

Note: For a more comprehensive explanation of the API library functions, see the Host API Design for MM7150 Application Note.

VREG_init (VREGS.c) – procedure for preparing motion module for data reporting

1. `hid_i2c_descriptor_handler(GET_HID_DESC)`
 - Retrieve and parse the HID descriptor table
2. `hid_i2c_cmd_process (POWER_ON)`
 - Wake the EC
3. `hid_i2c_cmd_process (RESET)`
 - Reset the EC
4. `hid_i2c_descriptor_handler(GET_REPT_DESC)`
 - Retrieve and parse report descriptor table
5. `hid_i2c_cmd_process (HID_GET_RPT_FEAT, rept_ID)`
 - Get feature reports for sensors

A.2.3 Enabling Sensors and Reading data

1. `HOST_SF_LIB_write(0, 0bXXXXXXXXXX0101)`
 - Enable one or multiple sensors
2. `HOST_SF_LIB_write regX, sensitivity value`
 - Optional - edit sensitivity per sensor
3. `HOST_SF_LIB_write regX, data rate value`
 - Optional - edit data rate per sensor
4. `HOST_SF_LIB_write(DATA_REG)`
 - Read input data from the enabled sensors



Appendix B. Reference Schematic & Bill of Materials

B.1 MM7150 MOTION MODULE PICTAIL™ PLUS EVALUATION BOARD

B.1.1 Bill of Materials

Designator	Quantity	Description	Value
J1	1	CON HDR-2.54 Male 1x4 Gold 5.84MH TH VERT	HDR-2.54 Male 1x4
J2	1	CON HDR-2.54 Male 1x6 Tin 5.84MH TH VERT	HDR-2.54 Male 1x6
J3	1	CON HDR-2.54 Female 1x6 Gold TH R/A	HDR-2.54 Female 1x6
JP1, JP2, JP3	3	CON HDR-2.54 Male 1x2	HDR-2.54 Male 1x2
LED1, LED2	2	DIO LED YELLOW 2.1V 30mA 6mcd Clear SMD 0805	YELLOW
LED3	1	LED 3MM RT ANG HI EFF GRN PC MNT - Dialight 551-0209F	GREEN
R1, R2, R4	3	RES TKF 301R 1% 1/10W SMD 0603	301R
R3, R5	2	RES TKF 10k 1% 1/16W SMD 0603, RES TKF 0R 1/10W SMD 0603	10k, DNP
R6	1	RES TKF 0R 1/10W SMD 0603	0R
R7, R8	2	RES TKF 2.21k 1% 1/10W SMD 0603	2.21k
R9	1	RES TKF 2.21k 1% 1/10W SMD 0603	DNP
U1	1	MM7150 Motion Module	

B.1.2 Reference Schematic

The MM7150 Motion Module PICTail™ Plus Evaluation Board (#AC243007) reference schematic is shown in the next page.

SSC7150 Module Footprint

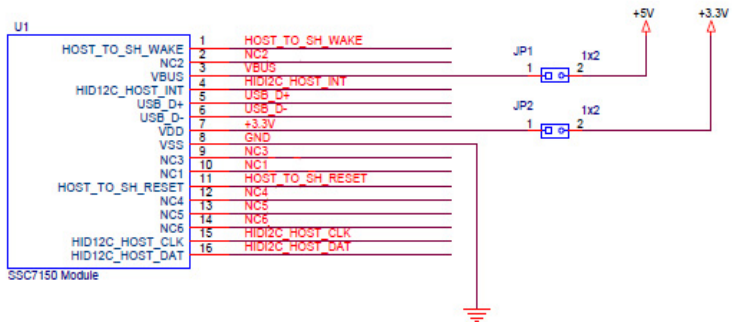

PICTail Plus Edge
 (Plug-In to Explorer 16 Dev. Board J5 connector)

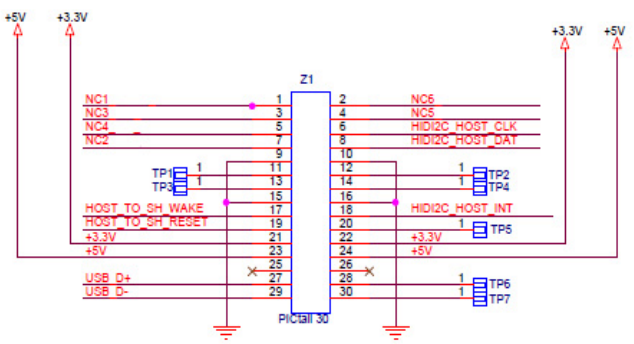

ICSP

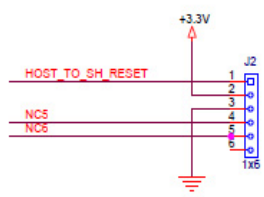

FW Debug



HIDI2C Host I/F

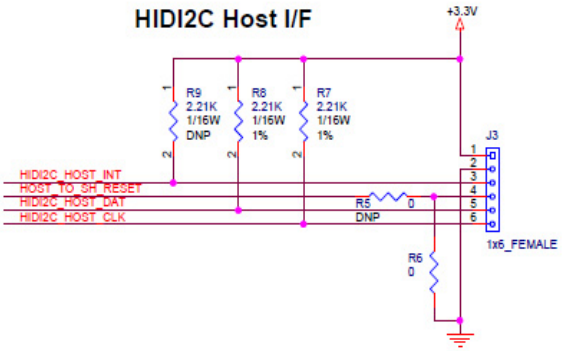

LEDs

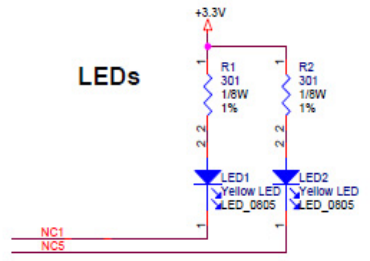

Debug Mode Strap

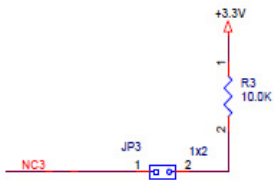

Power LED

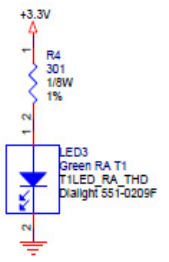

Appendix C. Extension Cable for Explorer 16

Please refer to MM7150-PICTail Reference Schematic ([B.1.2 “Reference Schematic”](#)) and create an extension cable of up to 20” (with proper shielding) for ease of motion during calibration.

Note: Per industry data, I²C bus at 400KHz without buffer can have length up to 2 meters with limiting factor of wiring capacitance. Designers should take this into consideration if planning to build longer extension cable which is out of scope of this user’s guide.

C.1 SIGNALS CONNECTION

TABLE C-1: CONNECTION SUMMARY BETWEEN MM7150 TO EXP16 BOARD

Signal Name	SSC7150 Module Pin	SSC7150 J3 Header	MM7150 Module Z1 PICTAIL Connector	Exp16 J6 Header Name	Exp16 J6 Header Pin
+3.3V	7	1	21	+3.3V	21
GND	8	2	15	GND	9
HIDI2C_HOST_INT	4	3	18	RE8/INT1	18
HIDI2C_HOST_DAT	16	5	8	RG3/SDA1	8
HIDI2C_HOST_CLK	15	6	6	RG2/SCL1	6
HOST_TO_SH_WAKE	1	NC	17	RE9	17



MICROCHIP

Worldwide Sales and Service

AMERICAS

Corporate Office
2355 West Chandler Blvd.
Chandler, AZ 85224-6199
Tel: 480-792-7200
Fax: 480-792-7277
Technical Support:
<http://www.microchip.com/support>

Web Address:
www.microchip.com

Atlanta
Duluth, GA
Tel: 678-957-9614
Fax: 678-957-1455

Austin, TX
Tel: 512-257-3370

Boston
Westborough, MA
Tel: 774-760-0087
Fax: 774-760-0088

Chicago
Itasca, IL
Tel: 630-285-0071
Fax: 630-285-0075

Cleveland
Independence, OH
Tel: 216-447-0464
Fax: 216-447-0643

Dallas
Addison, TX
Tel: 972-818-7423
Fax: 972-818-2924

Detroit
Novi, MI
Tel: 248-848-4000

Houston, TX
Tel: 281-894-5983

Indianapolis
Noblesville, IN
Tel: 317-773-8323
Fax: 317-773-5453

Los Angeles
Mission Viejo, CA
Tel: 949-462-9523
Fax: 949-462-9608

New York, NY
Tel: 631-435-6000

San Jose, CA
Tel: 408-735-9110

Canada - Toronto
Tel: 905-673-0699
Fax: 905-673-6509

ASIA/PACIFIC

Asia Pacific Office
Suites 3707-14, 37th Floor
Tower 6, The Gateway
Harbour City, Kowloon
Hong Kong
Tel: 852-2943-5100
Fax: 852-2401-3431

Australia - Sydney
Tel: 61-2-9868-6733
Fax: 61-2-9868-6755

China - Beijing
Tel: 86-10-8569-7000
Fax: 86-10-8528-2104

China - Chengdu
Tel: 86-28-8665-5511
Fax: 86-28-8665-7889

China - Chongqing
Tel: 86-23-8980-9588
Fax: 86-23-8980-9500

China - Dongguan
Tel: 86-769-8702-9880

China - Hangzhou
Tel: 86-571-8792-8115
Fax: 86-571-8792-8116

China - Hong Kong SAR
Tel: 852-2943-5100
Fax: 852-2401-3431

China - Nanjing
Tel: 86-25-8473-2460
Fax: 86-25-8473-2470

China - Qingdao
Tel: 86-532-8502-7355
Fax: 86-532-8502-7205

China - Shanghai
Tel: 86-21-5407-5533
Fax: 86-21-5407-5066

China - Shenyang
Tel: 86-24-2334-2829
Fax: 86-24-2334-2393

China - Shenzhen
Tel: 86-755-8864-2200
Fax: 86-755-8203-1760

China - Wuhan
Tel: 86-27-5980-5300
Fax: 86-27-5980-5118

China - Xian
Tel: 86-29-8833-7252
Fax: 86-29-8833-7256

ASIA/PACIFIC

China - Xiamen
Tel: 86-592-2388138
Fax: 86-592-2388130

China - Zhuhai
Tel: 86-756-3210040
Fax: 86-756-3210049

India - Bangalore
Tel: 91-80-3090-4444
Fax: 91-80-3090-4123

India - New Delhi
Tel: 91-11-4160-8631
Fax: 91-11-4160-8632

India - Pune
Tel: 91-20-3019-1500

Japan - Osaka
Tel: 81-6-6152-7160
Fax: 81-6-6152-9310

Japan - Tokyo
Tel: 81-3-6880-3770
Fax: 81-3-6880-3771

Korea - Daegu
Tel: 82-53-744-4301
Fax: 82-53-744-4302

Korea - Seoul
Tel: 82-2-554-7200
Fax: 82-2-558-5932 or
82-2-558-5934

Malaysia - Kuala Lumpur
Tel: 60-3-6201-9857
Fax: 60-3-6201-9859

Malaysia - Penang
Tel: 60-4-227-8870
Fax: 60-4-227-4068

Philippines - Manila
Tel: 63-2-634-9065
Fax: 63-2-634-9069

Singapore
Tel: 65-6334-8870
Fax: 65-6334-8850

Taiwan - Hsin Chu
Tel: 886-3-5778-366
Fax: 886-3-5770-955

Taiwan - Kaohsiung
Tel: 886-7-213-7828

Taiwan - Taipei
Tel: 886-2-2508-8600
Fax: 886-2-2508-0102

Thailand - Bangkok
Tel: 66-2-694-1351
Fax: 66-2-694-1350

EUROPE

Austria - Wels
Tel: 43-7242-2244-39
Fax: 43-7242-2244-393

Denmark - Copenhagen
Tel: 45-4450-2828
Fax: 45-4485-2829

France - Paris
Tel: 33-1-69-53-63-20
Fax: 33-1-69-30-90-79

Germany - Dusseldorf
Tel: 49-2129-3766400

Germany - Munich
Tel: 49-89-627-144-0
Fax: 49-89-627-144-44

Germany - Pforzheim
Tel: 49-7231-424750

Italy - Milan
Tel: 39-0331-742611
Fax: 39-0331-466781

Italy - Venice
Tel: 39-049-7625286

Netherlands - Drunen
Tel: 31-416-690399
Fax: 31-416-690340

Poland - Warsaw
Tel: 48-22-3325737

Spain - Madrid
Tel: 34-91-708-08-90
Fax: 34-91-708-08-91

Sweden - Stockholm
Tel: 46-8-5090-4654

UK - Wokingham
Tel: 44-118-921-5800
Fax: 44-118-921-5820

01/27/15