

MPU 9DOF click™

1. Introduction

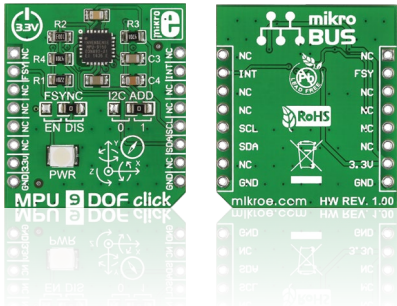

MPU 9DOF click™ carries the **MPU-9150 SiP (System in Package)**, which is the world's first 9-axis MotionTracking device. The device comprises two chips: one is the **MPU-6050** that contains a 3-axis accelerometer, a 3-axis gyroscope, and a DMP (digital motion processor); the other is **AK8975**, a 3-axis digital compass. MPU 9DOF click™ communicates with the target board through **mikroBUS™ I2C (SCL, SDA), INT and RST (FSYNC)** lines. It's designed to use a 3.3V power supply only.

2. Soldering the headers

Before using your click™ board, make sure to solder 1x8 male headers to both left and right side of the board. Two 1x8 male headers are included with the board in the package.



1

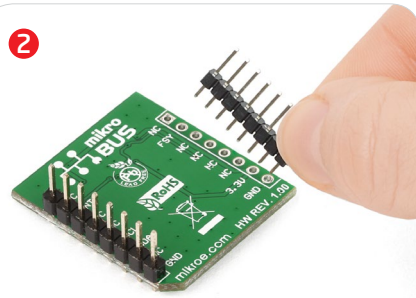

Turn the board upside down so that the bottom side is facing you upwards. Place shorter pins of the header into the appropriate soldering pads.

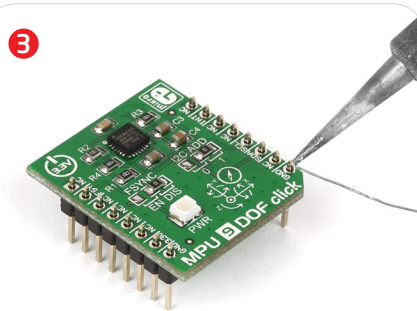

Turn the board upward again. Make sure to align the headers so that they are perpendicular to the board, then solder the pins carefully.

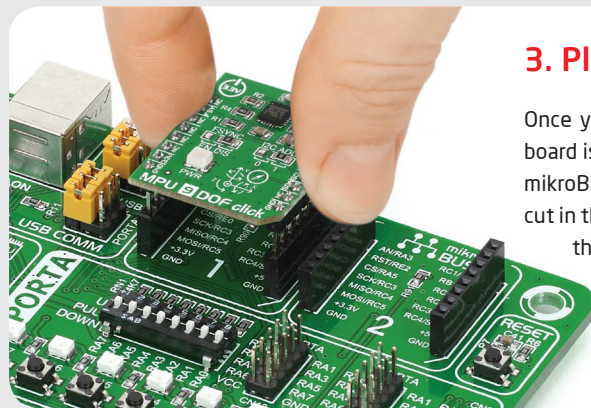

3. Plugging the board in

Once you have soldered the headers your board is ready to be placed into the desired mikroBUS™ socket. Make sure to align the cut in the lower-right part of the board with the markings on the silkscreen at the mikroBUS™ socket. If all the pins are aligned correctly, push the board all the way into the socket.

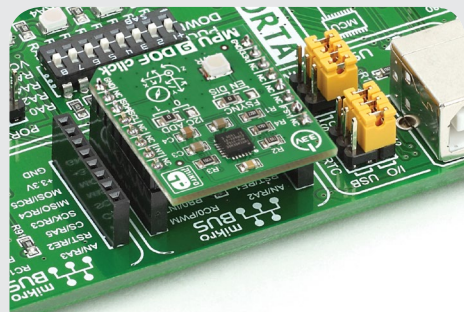

4. Essential features

The **MPU-9150** aboard MPU 9DOF click™ is designed for the low power, low cost and high performance requirements of consumer electronics equipment and wearable sensors. The ability to track motion in free space also makes MPU 9DOF click™ a suitable sensor when designing remote controlled quadcopters. The Tri-Axis gyro has a sensitivity up to 131 LSBs/dps and a full-scale range of ±250, ±500, ±1000, and ±2000dps; the Tri-Axis accelerometer with a programmable full scale range of ±2g, ±4g, ±8g and ±16g; and the tri-axis compass has a full scale range of ±1200μT.



MPU 9DOF click™ manual
ver. 1.00



0 100000 027325 1

5. MPU 9DOF click™ board schematic

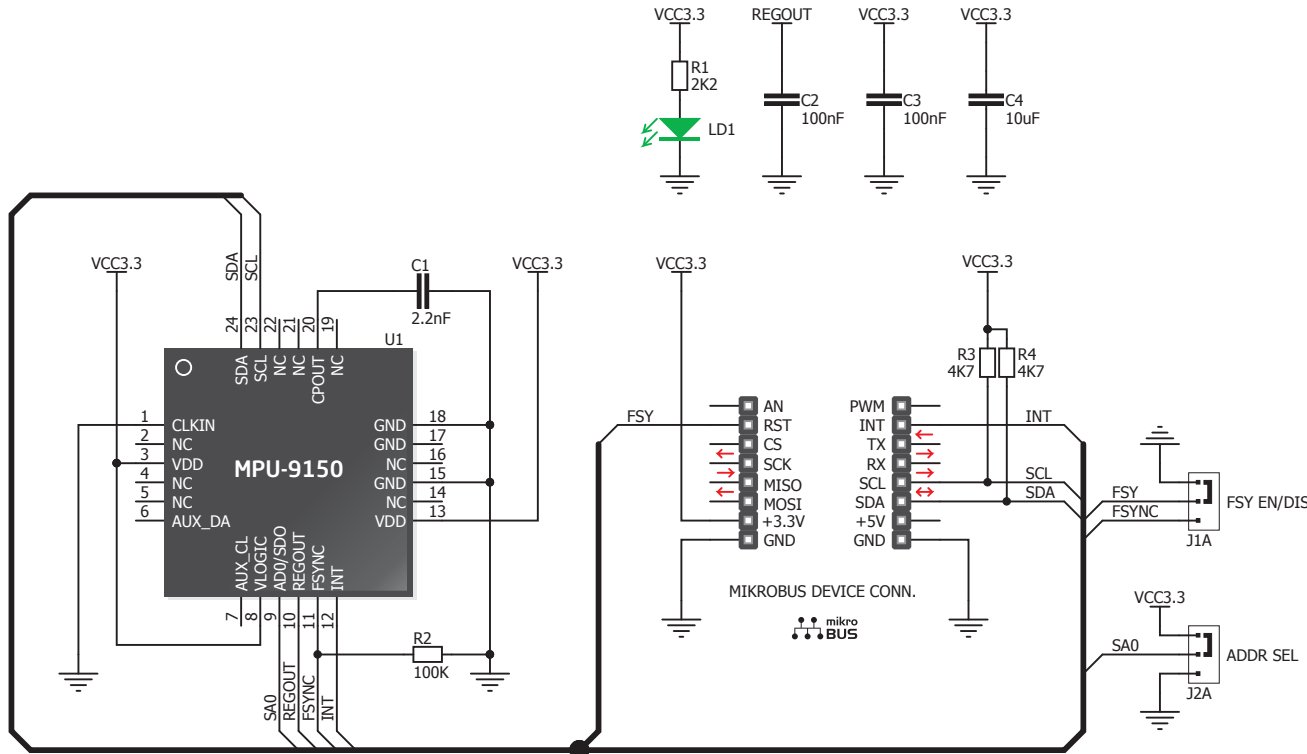

6. Zero-Ohm jumpers

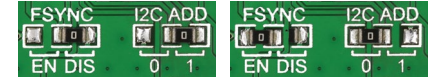

MPU 9DOF click™ has two jumpers (zero-Ohm resistors). FSYNC enables or disables the interrupt function on the FSYNC (RST) mikroBUS™ pin. I²C ADD allows you to select between the available I²C addresses.

7. Code examples

Once you have done all the necessary preparations, it's time to get your click™ board up and running. We have provided examples for mikroC™, mikroBasic™ and mikroPascal™ compilers on our **Libstock** website. Just download them and you are ready to start.



8. Support

MikroElektronika offers **free tech support** (www.mikroe.com/support) until the end of the product's lifetime, so if something goes wrong, we're ready and willing to help!