

PART No. ECPP1616

for more information visit
www.hammfg.com

Data subject to change without notice

Isometric drawing Not to Scale

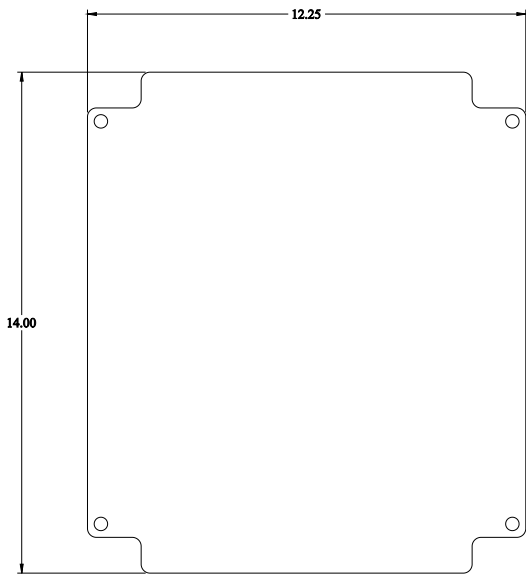

FRONT VIEW



SIDE VIEW

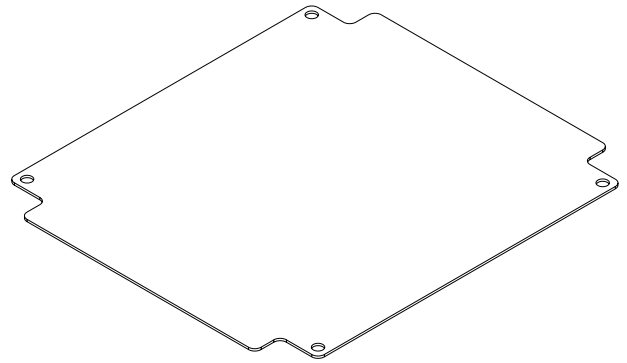

ISOMETRIC VIEW