

## N-Channel Power MOSFET

800V, 0.3A, 21.6Ω

### FEATURES

- Advanced planar process
- 100% avalanche tested
- Fast switching

### APPLICATION

- Power Supply
- Lighting

KEY PERFORMANCE PARAMETERS		
PARAMETER	VALUE	UNIT
$V_{DS}$	800	V
$R_{DS(on)}$ (max)	21.6	Ω
$Q_g$	5	nC



**SOT-223**

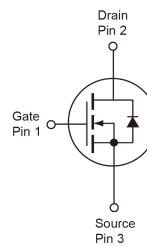
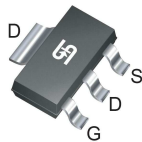

**Notes:** Moisture sensitivity level: level 3. Per J-STD-020

ABSOLUTE MAXIMUM RATINGS ( $T_A = 25^\circ\text{C}$ unless otherwise noted)			
PARAMETER	SYMBOL	LIMIT	UNIT
Drain-Source Voltage	$V_{DS}$	800	V
Gate-Source Voltage	$V_{GS}$	±30	V
Continuous Drain Current	$I_D$	0.3	A
Pulsed Drain Current <sup>(Note 1)</sup>	$I_{DM}$	1	A
Single Pulse Avalanche Energy <sup>(Note 2)</sup>	$E_{AS}$	90	mJ
Avalanche Current, Repetitive or Not-Repetitive <sup>(Note 1)</sup>	$I_{AR}$	1	A
Total Power Dissipation @ $T_C = 25^\circ\text{C}$	$P_{DTOT}$	2.1	W
Operating Junction Temperature	$T_J$	150	°C
Operating Junction and Storage Temperature Range	$T_J, T_{STG}$	- 55 to +150	°C

THERMAL PERFORMANCE			
PARAMETER	SYMBOL	LIMIT	UNIT
Junction to Ambient Thermal Resistance	$R_{\theta JA}$	60	°C/W

**Notes:**  $R_{\theta JA}$  is the sum of the junction-to-case and case-to-ambient thermal resistances. The case thermal reference is defined at the solder mounting surface of the drain pins.  $R_{\theta JA}$  is guaranteed by design while  $R_{\theta CA}$  is determined by the user's board design.  $R_{\theta JA}$  shown below for single device operation on FR-4 PCB in still air

<b>ELECTRICAL SPECIFICATIONS</b> ( $T_A = 25^\circ\text{C}$ unless otherwise noted)						
PARAMETER	CONDITIONS	SYMBOL	MIN	TYP	MAX	UNIT
<b>Static</b>						
Drain-Source Breakdown Voltage	$V_{GS} = 0V, I_D = 1mA$	$BV_{DSS}$	800	--	--	V
Drain-Source On-State Resistance	$V_{GS} = 10V, I_D = 0.15A$	$R_{DS(ON)}$	--	18	21.6	$\Omega$
Gate Threshold Voltage	$V_{DS} = V_{GS}, I_D = 250\mu A$	$V_{GS(TH)}$	3	--	5	V
Zero Gate Voltage Drain Current	$V_{DS} = 800V, V_{GS} = 0V$	$I_{DSS}$	--	--	25	$\mu A$
Gate Body Leakage	$V_{GS} = \pm 30V, V_{DS} = 0V$	$I_{GSS}$	--	--	$\pm 10$	$\mu A$
Forward Transconductance	$V_{DS} = 40V, I_D = 0.1A$	$g_{fs}$	--	0.36	--	S
Diode Forward Voltage	$I_S = 0.2A, V_{GS} = 0V$	$V_{SD}$	--	--	1.4	V
<b>Dynamic</b> (Note 3)						
Total Gate Charge	$V_{DS} = 640V, I_D = 0.3A,$ $V_{GS} = 10V$	$Q_g$	--	5	6	nC
Gate-Source Charge		$Q_{gs}$	--	1	--	
Gate-Drain Charge		$Q_{gd}$	--	2	--	
Input Capacitance	$V_{DS} = 25V, V_{GS} = 0V,$ $f = 1.0MHz$	$C_{iss}$	--	155	200	pF
Output Capacitance		$C_{oss}$	--	20	26	
Reverse Transfer Capacitance		$C_{rss}$	--	2.7	4	
<b>Switching</b> (Note 4)						
Turn-On Delay Time	$V_{GS} = 10V, I_D = 0.3A,$ $V_{DS} = 400V, R_G = 25\Omega$	$t_{d(on)}$	--	10	30	ns
Turn-On Rise Time		$t_r$	--	20	50	
Turn-Off Delay Time		$t_{d(off)}$	--	16	45	
Turn-Off Fall Time		$t_f$	--	25	60	

**Note:**

1. Pulse test: pulse width  $\leq 300\mu s$ , duty cycle  $\leq 2\%$
2. ( $V_{DD} = 50V, I_{AS} = 0.8A, L = 170mH, R_G = 25\Omega$ )
3. For design reference only, not subject to production testing.
4. Switching time is essentially independent of operating temperature.

**ORDERING INFORMATION**

<b>PART NO.</b>	<b>PACKAGE</b>	<b>PACKING</b>
TSM1N80CW RPG	SOT-223	2,500pcs / 13" Reel

**Note:**

1. Compliant to RoHS Directive 2011/65/EU and in accordance to WEEE 2002/96/EC
2. Halogen-free according to IEC 61249-2-21 definition

**CHARACTERISTICS CURVES**

( $T_A = 25^\circ\text{C}$  unless otherwise noted)

**Output Characteristics**

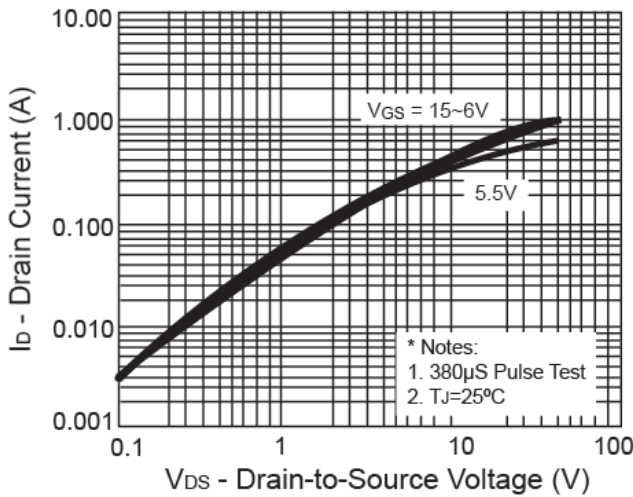

**Transfer Characteristics**

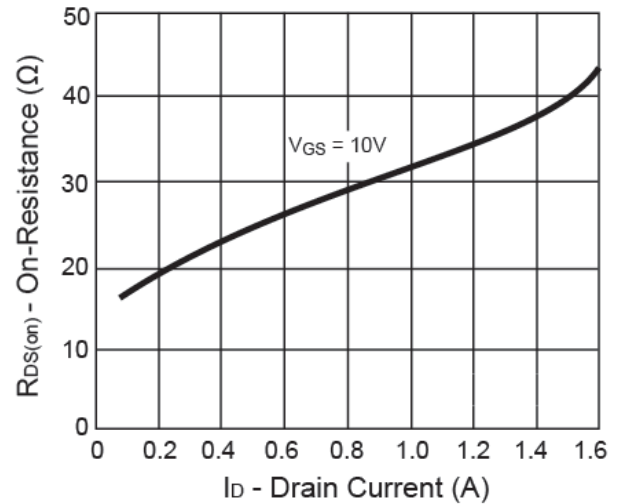

**On-Resistance vs. Drain Current**

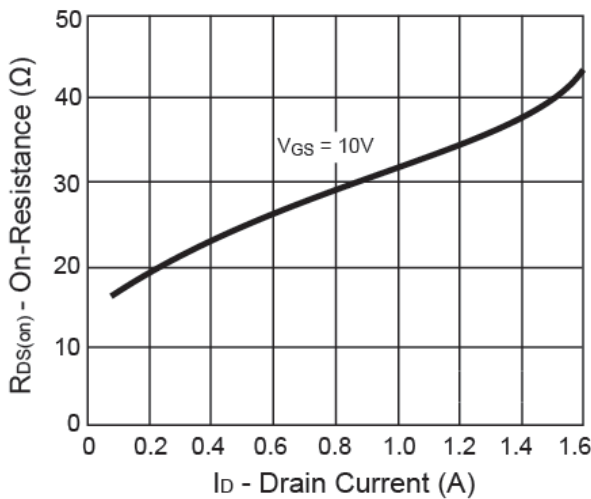

**Gate Charge**

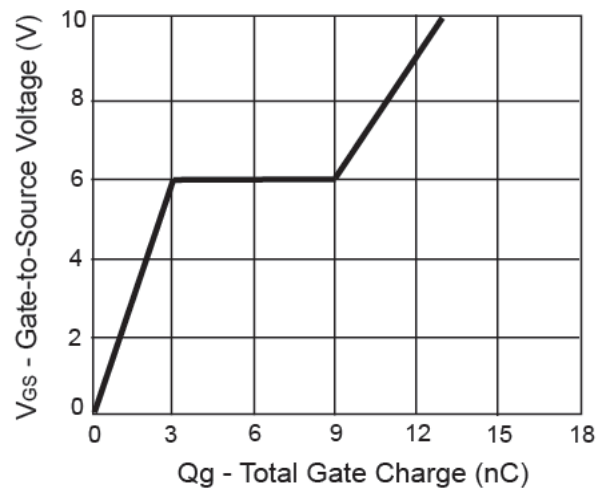

**On-Resistance vs. Junction Temperature**

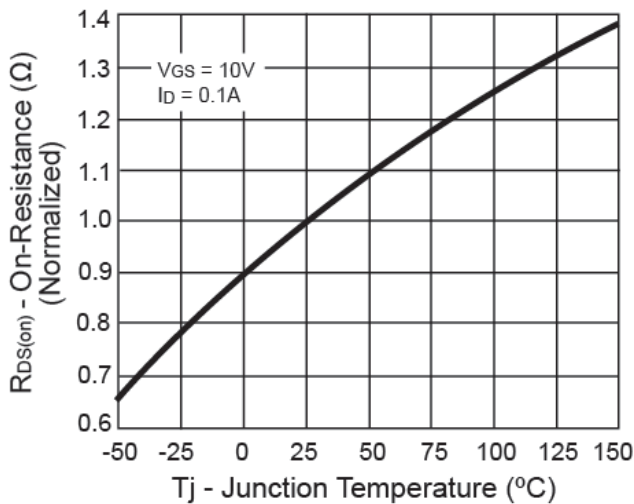

**Source-Drain Diode Forward Voltage**

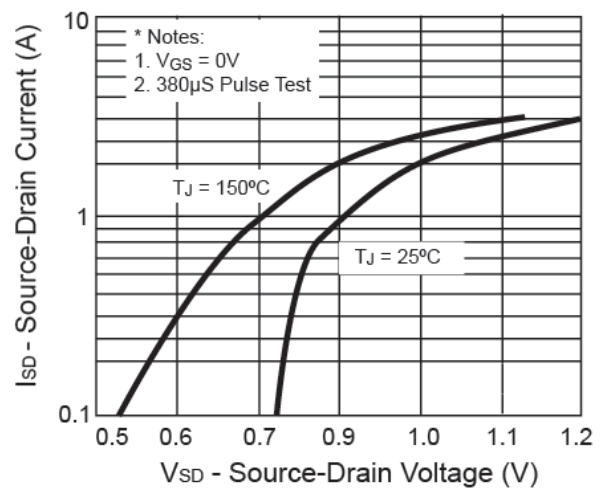

**CHARACTERISTICS CURVES**

( $T_A = 25^\circ\text{C}$  unless otherwise noted)

**On-Resistance vs. Gate-Source Voltage**

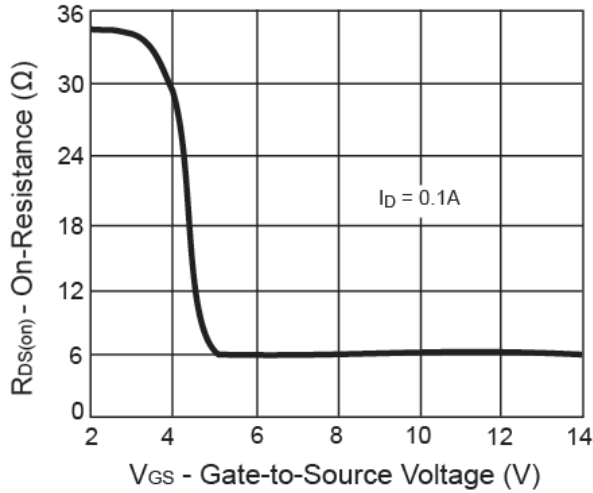

**Threshold Voltage**

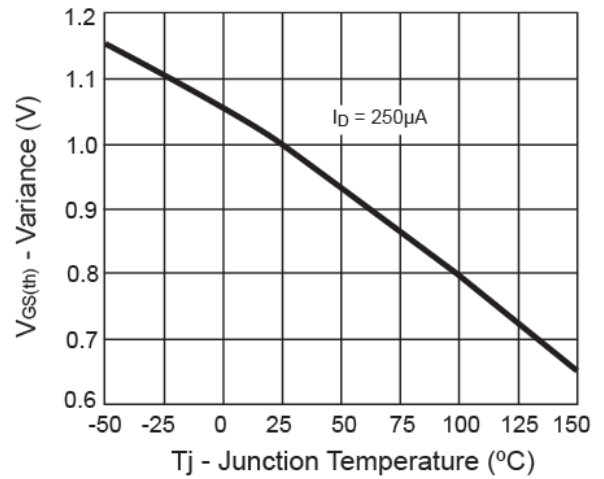

**Maximum Safe Operating Area**

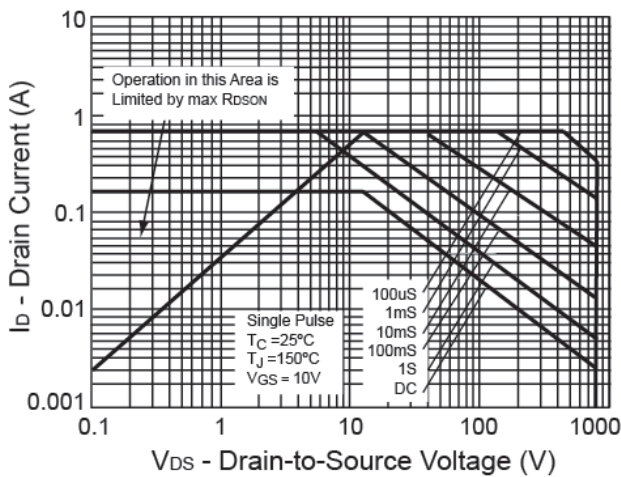

**Normalized Thermal Transient Impedance, Junction-to-Ambient**

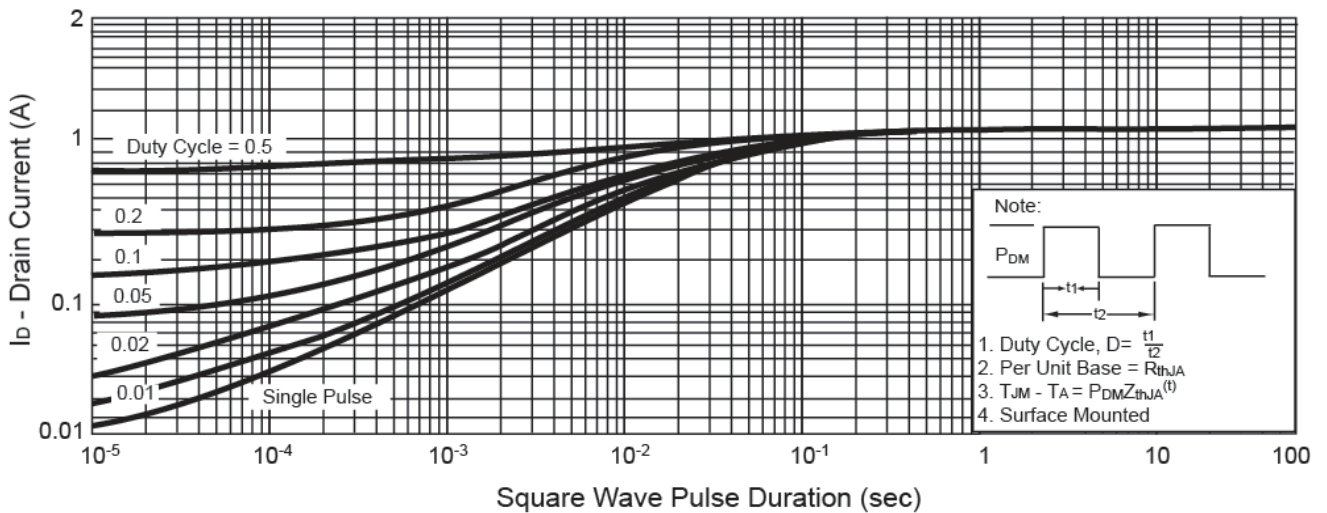

**PACKAGE OUTLINE DIMENSIONS** (Unit: Millimeters)

**SOT-223**

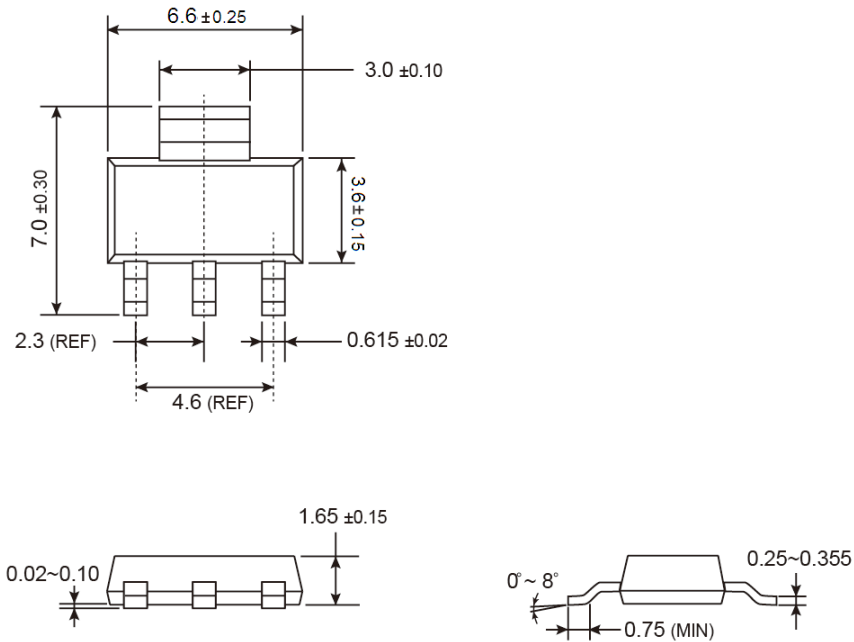

**SUGGESTED PAD LAYOUT** (Unit: Millimeters)

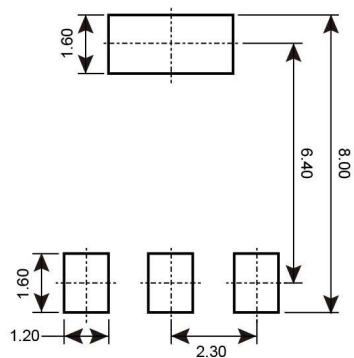

**MARKING DIAGRAM**

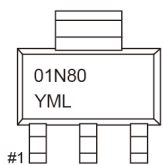

- Y = Year Code
- M = Month Code for Halogen Free Product
  - O =Jan    P =Feb    Q =Mar    R =Apr
  - S =May    T =Jun    U =Jul    V =Aug
  - W =Sep    X =Oct    Y =Nov    Z =Dec
- L = Lot Code (1~9, A~Z)

## Notice

Specifications of the products displayed herein are subject to change without notice. TSC or anyone on its behalf, assumes no responsibility or liability for any errors or inaccuracies.

Information contained herein is intended to provide a product description only. No license, express or implied, to any intellectual property rights is granted by this document. Except as provided in TSC's terms and conditions of sale for such products, TSC assumes no liability whatsoever, and disclaims any express or implied warranty, relating to sale and/or use of TSC products including liability or warranties relating to fitness for a particular purpose, merchantability, or infringement of any patent, copyright, or other intellectual property right.

The products shown herein are not designed for use in medical, life-saving, or life-sustaining applications. Customers using or selling these products for use in such applications do so at their own risk and agree to fully indemnify TSC for any damages resulting from such improper use or sale.