



868MHz HumDT™ Series
RF Transceiver Module
Data Guide

Wireless made simple®

Warning: Some customers may want Linx radio frequency (“RF”) products to control machinery or devices remotely, including machinery or devices that can cause death, bodily injuries, and/or property damage if improperly or inadvertently triggered, particularly in industrial settings or other applications implicating life-safety concerns (“Life and Property Safety Situations”).

NO OEM LINX REMOTE CONTROL OR FUNCTION MODULE SHOULD EVER BE USED IN LIFE AND PROPERTY SAFETY SITUATIONS. No OEM Linx Remote Control or Function Module should be modified for Life and Property Safety Situations. Such modification cannot provide sufficient safety and will void the product’s regulatory certification and warranty.

Customers may use our (non-Function) Modules, Antenna and Connectors as part of other systems in Life Safety Situations, but only with necessary and industry appropriate redundancies and in compliance with applicable safety standards, including without limitation, ANSI and NFPA standards. It is solely the responsibility of any Linx customer who uses one or more of these products to incorporate appropriate redundancies and safety standards for the Life and Property Safety Situation application.

Do not use this or any Linx product to trigger an action directly from the data line or RSSI lines without a protocol or encoder/decoder to validate the data. Without validation, any signal from another unrelated transmitter in the environment received by the module could inadvertently trigger the action.

All RF products are susceptible to RF interference that can prevent communication. RF products without frequency agility or hopping implemented are more subject to interference. This module does not have a frequency hopping protocol built in.

Do not use any Linx product over the limits in this data guide. Excessive voltage or extended operation at the maximum voltage could cause product failure. Exceeding the reflow temperature profile could cause product failure which is not immediately evident.

Do not make any physical or electrical modifications to any Linx product. This will void the warranty and regulatory and UL certifications and may cause product failure which is not immediately evident.

Table of Contents

1	Description
1	Features
2	Ordering Information
2	Absolute Maximum Ratings
3	Electrical Specifications
5	Typical Performance Graphs
10	Pin Assignments
10	Pin Descriptions
12	Theory of Operation
13	Module Description
14	Networking
15	Initialization and Joining
16	Addressing
17	Channel Selection and Regulatory Compliance
20	GPIO Configuration
20	Baud Rate
21	Using the Low Power Features
21	External Amplifier Control
22	Encryption
23	Restore Factory Defaults
24	Command Data Interface
26	The Command Data Interface Command Set
53	Typical Applications
54	Power Supply Requirements
54	Antenna Considerations
55	Helpful Application Notes from Linx
56	Interference Considerations
57	Pad Layout
57	Board Layout Guidelines

- 59 [Microstrip Details](#)
- 60 [Production Guidelines](#)
- 60 [Hand Assembly](#)
- 60 [Automated Assembly](#)
- 62 [General Antenna Rules](#)
- 64 [Common Antenna Styles](#)
- 66 [Regulatory Considerations](#)

868MHz HumDT™ Series RF Transceiver Module

Data Guide



Description

The HumDT™ Series transceiver is designed for the reliable wireless transfer of serial digital data. It consists of a highly optimized RF transceiver and integrated data and networking protocol.

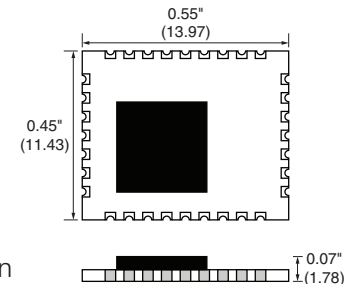

Figure 1: Package Dimensions

The 868MHz version offers 68 channels within the 863 to 870MHz band so that the user can select the best channel for the application. A

serial command selects the channel as well as other configuration settings.

The HumDT™ Series supports star and extended star networks with up to 50 nodes. The fast turn-on time means the module can power-up, send data and go back to sleep very quickly, which is ideal for battery-powered applications. This makes the HumDT™ Series ideal for wireless sensor networks and similar applications where battery life is important.

The module can achieve a line-of-sight range of up to 1,600m (1.0 mile). The final range may be less depending on the regulatory requirements for the channel of operation as well as antenna implementation.

The module's UART interface is used for module configuration and data transfer. 8 GPIOs can be used for analog and digital functions and are controlled through the UART. Housed in a compact reflow-compatible SMD package, the transceiver requires no external RF components except an antenna, which greatly simplifies integration and lowers assembly costs.

Features

- 8 analog and digital GPIOs
- Low power receive modes
- Simple UART interface
- AES-128 Encryption
- No external RF components required
- No production tuning required
- Tiny PLCC-32 footprint

Ordering Information

Ordering Information	
Part Number	Description
HUM-868-DT	868MHz HumDT™ Series Transceiver
EVM-868-DT	868MHz HumDT™ Series Carrier Board
MDEV-868-DT	868MHz HumDT™ Series Master Development System

Figure 2: Ordering Information

Absolute Maximum Ratings

Absolute Maximum Ratings				
Supply Voltage V_{CC}	-0.3	to	+3.9	VDC
Any Input or Output Pin	-0.3	to	$V_{CC} + 0.3$	VDC
RF Input		0		dBm
Operating Temperature	-40	to	+85	°C
Storage Temperature	-40	to	+85	°C

Exceeding any of the limits of this section may lead to permanent damage to the device. Furthermore, extended operation at these maximum ratings may reduce the life of this device.

Figure 3: Absolute Maximum Ratings

 **Warning:** This product incorporates numerous static-sensitive components. Always wear an ESD wrist strap and observe proper ESD handling procedures when working with this device. Failure to observe this precaution may result in module damage or failure.

Electrical Specifications

HumDT™ Series Transceiver Specifications						
Parameter	Symbol	Min.	Typ.	Max.	Units	Notes
Power Supply						
Operating Voltage	V_{CC}	2.0		3.6	VDC	
TX Supply Current	I_{CCTX}					
at +10dBm			38	40	mA	1,2
at 0dBm			20.5	24	mA	1,2,3
RX Supply Current	I_{CCRX}		22	28	mA	1,2,3,4
Sleep Current	I_{SLP}		4.5	5	mA	1,2
Power-Down Current	I_{PDN}		0.3	2	μA	1,2
Idle Current	I_{IDL}		4.5	5	mA	1,2
RF Section						
Operating Frequency Band	F_C	863		870	MHz	
Number of Channels			68			
Channel Spacing			100		kHz	
Data Rate						
RF Data Rate		26		250	kbps	
Serial Data Rate		1.2		115.2	kbps	
Receiver Section						
Spurious Emissions				-47	dBm	
Receiver Sensitivity						
@ min rate		-98	-101		dBm	6
@ max rate		-89	-92		dBm	6
RSSI Dynamic Range			85		dB	
Transmitter Section						
Output Power	P_O	+8.5	+9.5		dBm	7
Harmonic Emissions	P_H		-41		dBc	7
Output Power Control Range		-30		10	dB	7
Antenna Port						
RF Impedance	R_{IN}		50		Ω	5
Environmental						
Operating Temp. Range		-40		+85	°C	5
Timing						
Module Turn-On Time						
Via V_{CC}				43	ms	11

HumDT™ Series Transceiver Specifications

Parameter	Symbol	Min.	Typ.	Max.	Units	Notes
Via POWER_DOWN				47	ms	11
Via Sleep				3	ms	11
Serial Command Response						
Status, Volatile R/W			1.5	2.5	ms	8
Analog Input Reading			10	11	ms	8
NV Update, Factory Reset			24	27	ms	8
Minimum Time between Command Packets		100			ms	
Interface Section						
Input						
Logic Low	V_{IL}			$0.3 \cdot V_{CC}$	VDC	
Logic High	V_{IH}	$0.7 \cdot V_{CC}$			VDC	
Output						
Logic Low, LED_0, LED_1	V_{OLM}			$0.3 \cdot V_{CC}$	VDC	1,9
Logic High, LED_0, LED_1	V_{OHM}	$0.7 \cdot V_{CC}$			VDC	1,9
Logic Low	V_{OL}			$0.3 \cdot V_{CC}$		1,10
Logic High	V_{OH}	$0.7 \cdot V_{CC}$				1,10

1. Measured at $3.3V V_{CC}$
2. Measured at $25^{\circ}C$
3. MAX value represents extreme of HUM family; HumDT value is lower
4. Input power < $-60dBm$
5. Characterized but not tested
6. PER = 1%
7. Into a 50-ohm load
8. From end of command to start of response
9. 60mA source/sink
10. 6mA source/sink
11. HUM-DT in single-channel ED mode, time to accept joining network

Figure 4: Electrical Specifications

Typical Performance Graphs

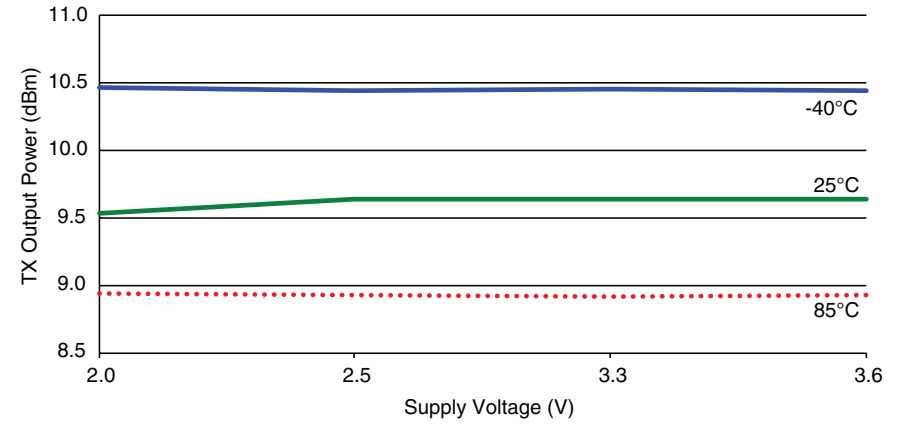

Figure 5: HumDT™ Series Transceiver Max Output Power vs. Supply Voltage - HUM-900-DT

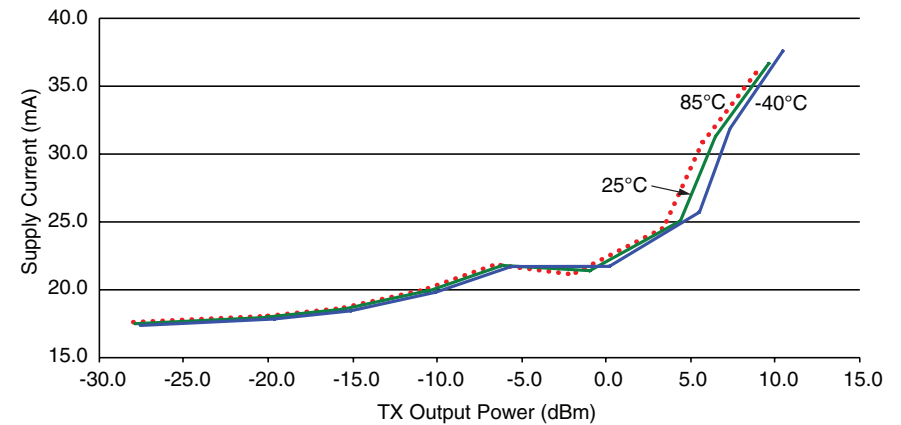

Figure 6: HumDT™ Series Transceiver Average Current vs. Transmitter Output Power at 2.5V - HUM-900-DT

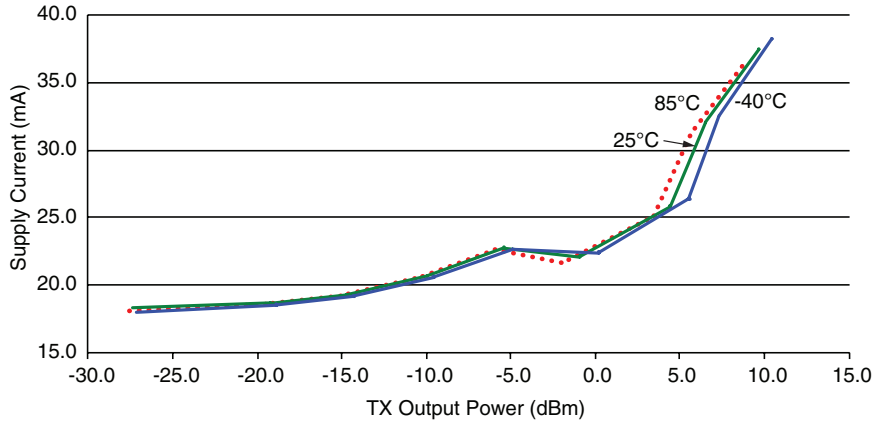

Figure 8: HumDT™ Series Transceiver Average TX Current vs. Transmitter Output Power at 3.3V - HUM-900-DT

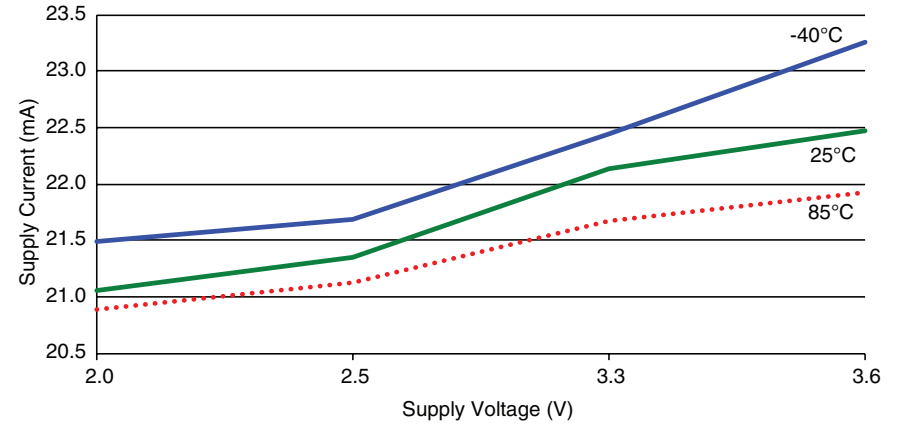

Figure 9: HumDT™ Series Transceiver TX Current vs. Supply Voltage at 0dBm - HUM-900-DT

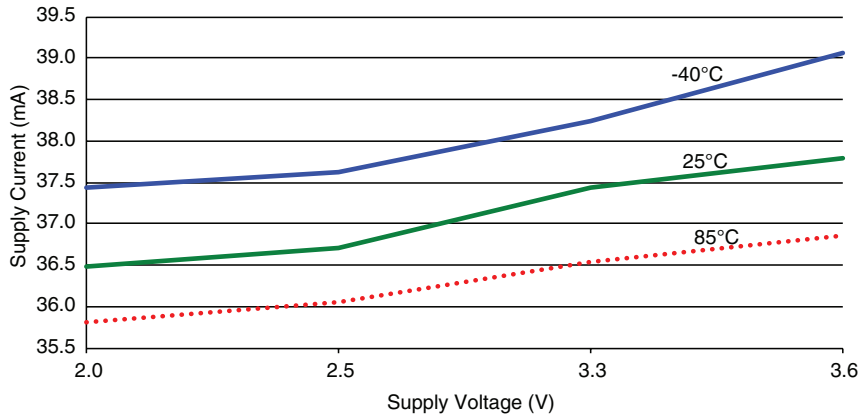

Figure 7: HumDT™ Series Transceiver TX Current vs. Supply Voltage at Max Power - HUM-900-DT

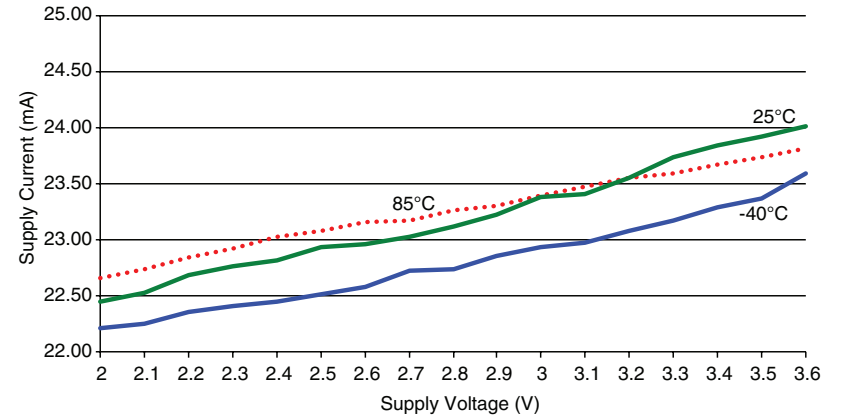

Figure 10: HumDT™ Series Transceiver RX Current Consumption vs. Supply Voltage - HUM-900-DT

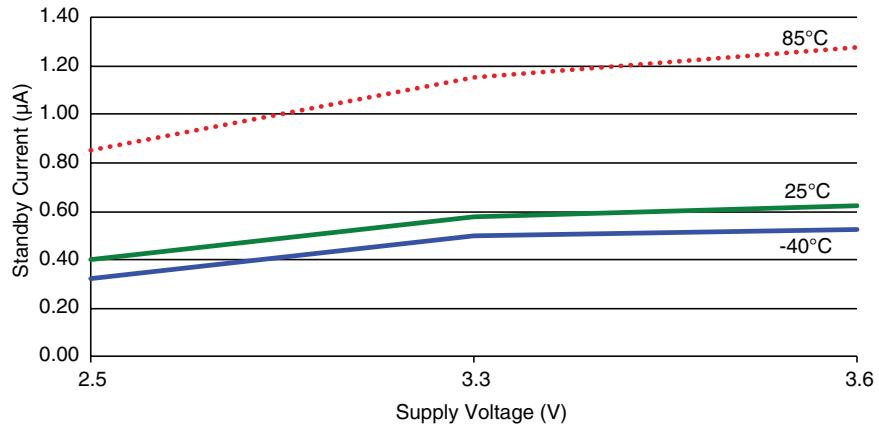

Figure 11: HumDT™ Series Transceiver Standby Current Consumption vs. Supply Voltage - HUM-900-DT

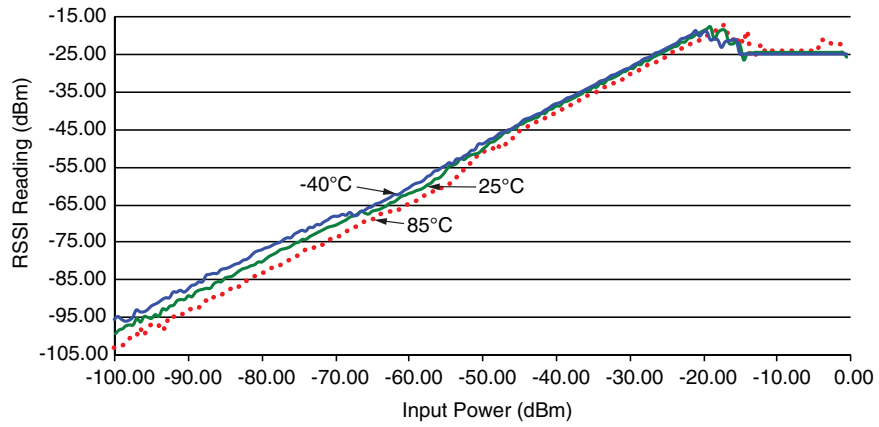

Figure 12: HumDT™ Series Transceiver RSSI Voltage vs. Input Power - HUM-900-DT

Pin Assignments

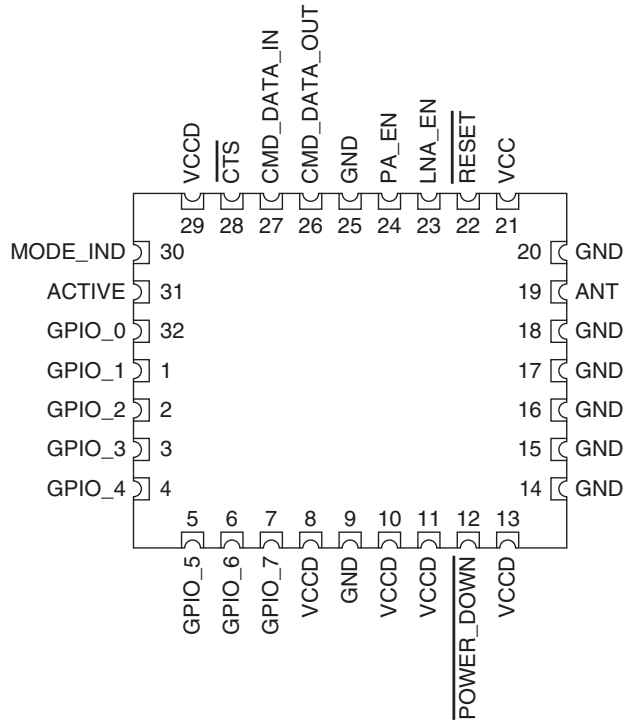

Figure 13: HumDT™ Series Transceiver Pin Assignments (Top View)

Pin Descriptions

Pin Descriptions			
Pin Number	Name	I/O	Description
1, 2, 3, 4, 5, 6, 7, 32	GPIO_0–GPIO_7	I/O	General Purpose I/O Lines. Each line can be configured as either an analog input, a digital input or a digital output. The digital inputs can be configured to have either a 20kΩ pull up or pull down resistance or high impedance (no resistors).
8, 10, 11, 13, 29	VCCD	—	These lines are inputs that are pulled to supply internally. They can be left unconnected, but boards in noisy environments or with noisy components in the same product are recommended to pull these lines to V_{CC} . The potential exists for random noise to affect the line and cause unexpected operation. This risk is reduced in simple, battery powered applications, but should be considered in all designs.

Pin Descriptions			
Pin Number	Name	I/O	Description
9, 14, 15, 16, 17, 18, 20, 25	GND	—	Ground
12	$\overline{\text{POWER_DOWN}}$	I	Power Down. Pulling this line low places the module into a low-power state. The module is not functional in this state. Pull high for normal operation. Do not leave floating.
19	ANTENNA	—	50-ohm RF Antenna Port
21	VCC	—	Supply Voltage
22	$\overline{\text{RESET}}$	I	This line resets the module when pulled low. It should be pulled high for normal operation. This line has an internal 10k resistor to supply, so leave it unconnected if not used.
23	LNA_EN	O	Low Noise Amplifier Enable. This line is driven high when receiving. It is intended to activate an optional external LNA.
24	PA_EN	O	Power Amplifier Enable. This line is driven high when transmitting. It is intended to activate an optional external power amplifier.
26	CMD_DATA_OUT	O	Command Data Out. Output line for the serial interface commands
27	CMD_DATA_IN	I	Command Data In. Input line for the serial interface commands. If serial control is not used, this line should be tied to ground or $\overline{\text{POWER_DOWN}}$ to minimize current consumption.
28	$\overline{\text{CTS}}$	O	UART Clear To Send, active low. This line indicates to the host microcontroller when the module is ready to accept data. When $\overline{\text{CTS}}$ is high, the module is busy. When $\overline{\text{CTS}}$ is low, the module is ready for data.
30	MODE_IND	O	This output goes high when the module is sending or receiving data over the air. This line can directly drive an LED for visual indication of activity.
31	ACTIVE	O	This output goes high when the module is powered on and functional. This line can directly drive an LED for visual indication of activity.

Figure 14: HumDT™ Series Transceiver Pin Descriptions

Theory of Operation

The HumDT™ Series transceiver is a low-cost, high-performance synthesized MSK transceiver. Figure 15 shows the module's block diagram.

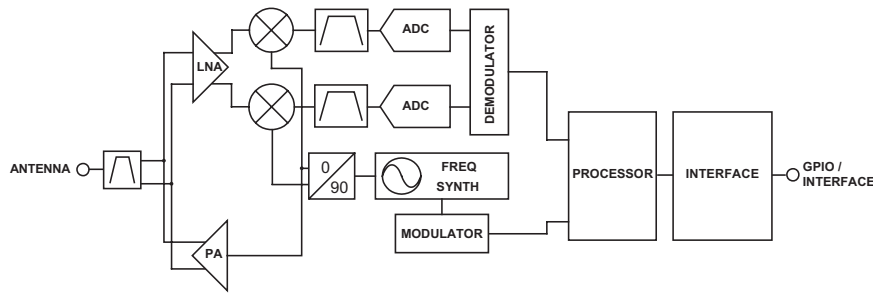

Figure 15: HumDT™ Series Transceiver RF Section Block Diagram

The HumDT™ Series transceiver operates in the 863 to 870MHz and 902 to 928MHz frequency bands. The transmitter output power is programmable. The range varies depending on the module's frequency band, antenna implementation and the local RF environment.

The RF carrier is generated directly by a frequency synthesizer that includes an on-chip VCO. The received RF signal is amplified by a low noise amplifier (LNA) and down-converted to I/Q quadrature signals. The I/Q signals are digitized by ADCs.

A low-power onboard communications processor performs the radio control and management functions including Automatic Gain Control (AGC), filtering, demodulation and packet synchronization. A control processor performs the higher level functions and controls the serial and hardware interfaces.

A crystal oscillator generates the reference frequency for the synthesizer and clocks for the ADCs and the processor.

Module Description

The HumDT™ Series module is a completely integrated RF transceiver and processor designed to transmit digital data across a wireless link. It has a built-in over-the-air protocol that manages all of the transmission and reception functions. It takes data in on its UART and supplies the data out of a UART on the remote module.

The module supports 68 channels in the 863 to 870MHz band. The channel is selected with a simple serial command, so it can be changed dynamically. It is important to be sure the end product complies with the power and duty cycle requirements for the channel of operation.

The modules can be used to set up a star network with one module acting as the central hub or access point and up to 50 other modules as end nodes connected to the hub. The module supports one-hop routing so that the end nodes can communicate with each other through the access point. The network can also support up to four range extenders that can boost the physical size of the network.

Each module has 8 GPIOs that can be configured as digital inputs or outputs or as analog inputs. These are controlled through serial commands used by the module's Command Data Interface through a UART. These can act as a GPIO expander or as sensor voltage inputs.

A standard UART interface is used to configure the module for operation and for the data input and output. This is suitable for direct connection to UARTs on many microcontrollers, USB converters and RS-232 converters. A simple command set is used for configuration and data input.

Networking

Each module can be configured as one of three device types; Access Point (AP), Range Extender (RE), and End Device (ED). These device types play a specific role in creating a star network.

The AP acts as the hub in a star network. It is an always-on device and only one AP is permitted per network. It receives all packets within its range and is capable of relaying messages from one ED to another.

The REs are always-on devices that extend the radio range on a network. They retransmit all received messages from devices in its network that are within range. This relaying of data extends the range of the network. Networks are limited to a maximum of four REs.

EDs are the simplest devices. They perform the actions in the network, such as remote control handhelds, sensors and actuators. The EDs may be battery powered and can be put into a low power mode to save current consumption.

There can be a maximum of 50 EDs in each network, with 1 AP and up to 4 REs.

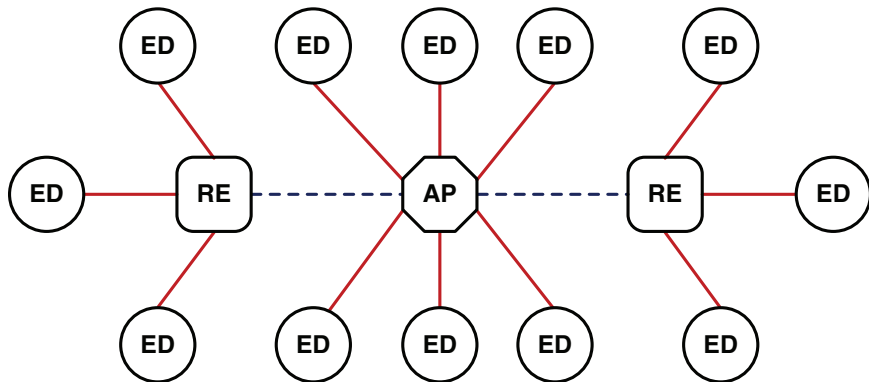

Figure 16: HumDT™ Series Transceiver Star Network

Each ED communicates with the AP either directly or through an RE. The AP can output the received data from the ED or forward the data on to another ED, depending on the addressing in the packet.

The AP sends out a beacon message about every 30 seconds to maintain the network. This is an automatic message and is not output by the module, though the MODE_IND line indicates the activity.

Initialization and Joining

The module runs through an initialization routine when it is powered up. It reads the operational configuration from its non-volatile memory and loads them into its volatile memory. The volatile memory is lost when power is removed, but it is faster to access so is better when the module is active. The module initializes all of the routines with the configuration settings and enters its device type, either AP, ED or RE.

Based on the device type setting, the module then begins the join and linking process. The join process is how an ED or RE gains access to an AP and joins a network. Once the module is joined, it sets up the link to the AP so that it can communicate its data.

All of this happens automatically when power is applied. If an AP and several EDs are brought online at the same time, the AP manages communication until all EDs are joined. No intervention is required by the user or an external microcontroller.

Once the initialization and join processes have been completed, the module outputs an initialization complete message on the CMD_DATA_OUT line. This is shown in Figure 57 in the Command Data Interface (CDI) Command Set section. This process occurs when the module is first powered on and when it wakes from sleep.

The CDI has commands for managing the modules associated with an AP. These include returning a count of associated modules, the full list of addresses of associated modules, and a command to delete a module from the list. Once an ED is deleted from the list no communications can occur until the module rejoins the network. This happens automatically when the power is cycled to the ED or the reset command is issued.

Addressing

There are two addresses used by the modules; the module address and the network ID. The module address is a 4 byte number that identifies the specific module in the network. This number is unique to the module and cannot be repeated within a network.

The network ID is a 4 byte number that is used to identify which network the module is in. This is shared by all modules within the network.

Modules that have different network IDs can have the same module address. No module should have the same module address and network ID. If this happens, the first module that contacts the AP is accepted into the network and the second is rejected and cannot communicate with the AP.

Each module is programmed with a unique 4 byte serial number at the factory. This can be used as the module address by reading it out through the CDI and writing it back as the local address. The serial number cannot be changed. This can ensure that every module in the system has a unique address rather than having to track addresses separately.

If two networks are operating in proximity, then it is possible for modules to hear transmissions from the other network. If the network ID in the received packet does not match the module's local network ID, then the packet is ignored and discarded.

Each module can also report out the modules it is linked to in the network. EDs only return the address of the AP. The AP outputs the addresses for all of the EDs that it has joined and linked to in the network. This is accomplished with a serial command through the module's Command Data Interface. This is a convenient way to quickly establish the entire network from the AP.

The REs do not have the intelligence to record all of the modules in its range. They respond with 0 associated modules.

Channel Selection and Regulatory Compliance

The module transmits on a single channel at a time. By default, it operates on channel 30 (866.15MHz), but this can be changed through the module's Command Data Interface. There are a total of 68 channels spaced at 100kHz intervals across the 863 - 870MHz band. These are shown in Figure 17.

The channels are designed to comply with Europe's ETSI regulations. Under these regulations, use of the 868MHz band is subject to certain conditions. These conditions vary based on the specific frequency of operation within the band, but generally limit the output power and the transmit time.

The transmit time is of particular note. This is specified in terms of Duty Cycle, which is the amount of time the transmitter can be active in a one-hour period. ERC Recommendation 70-03 summarizes the use of the 868MHz band by frequency and application. There are other standards and technical specifications that are applicable within the framework of the R&TTE Directive before a product can be placed on the market, but this recommendation provides a good summary of the major operational requirements. Figure 18 shows some of the key regulations across the band.

As a note, channel 65 falls on the edge between two operational bands, so it is not recommended for use.



Warning: The HumDT™ module does not provide any internal limits on transmitter duty cycle or transmitter output power based on the operational frequency. It is up to the designer to provide these controls and ensure that the end product is compliant with the appropriate regulations.



Warning: Government regulations can change at any time without notice and do frequently get updated. The information in this guide is provided as a courtesy, but the most recent regulations for the intended country of operation should always be consulted before taking a product to market.

Channel Frequencies					
Channel Number	Frequency (MHz)	Duty Cycle	Channel Number	Frequency (MHz)	Duty Cycle
0	863.15	0.10%	35	866.65	0.10%
1	863.25	0.10%	36	866.75	0.10%
2	863.35	0.10%	37	866.85	0.10%
3	863.45	0.10%	38	866.95	0.10%
4	863.55	0.10%	39	867.05	0.10%
5	863.65	0.10%	40	867.15	0.10%
6	863.75	0.10%	41	867.25	0.10%
7	863.85	0.10%	42	867.35	0.10%
8	863.95	0.10%	43	867.45	0.10%
9	864.05	0.10%	44	867.55	0.10%
10	864.15	0.10%	45	867.65	0.10%
11	864.25	0.10%	46	867.75	0.10%
12	864.35	0.10%	47	867.85	0.10%
13	864.45	0.10%	48	867.95	0.10%
14	864.55	0.10%	49	868.05	1.00%
15	864.65	0.10%	50	868.15	1.00%
16	864.75	0.10%	51	868.25	1.00%
17	864.85	0.10%	52	868.35	1.00%
18	864.95	0.10%	53	868.45	1.00%
19	865.05	0.10%	54	868.55	1.00%
20	865.15	0.10%	55	868.65	0.10%
21	865.25	0.10%	56	868.75	0.10%
22	865.35	0.10%	57	868.85	0.10%
23	865.45	0.10%	58	868.95	0.10%
24	865.55	0.10%	59	869.05	0.10%
25	865.65	0.10%	60	869.15	0.10%
26	865.75	0.10%	61	869.25	0.10%
27	865.85	0.10%	62	869.35	0.10%
28	865.95	0.10%	63	869.45	10.00%
29	866.05	0.10%	64	869.55	10.00%
30	866.15	0.10%	65	869.65	NA
31	866.25	0.10%	66	869.75	None / 1%
32	866.35	0.10%	67	869.85	None / 1%
33	866.45	0.10%	68	869.95	None / 1%
34	866.55	0.10%			

Figure 17: HumDT™ Series Transceiver Channel Frequencies

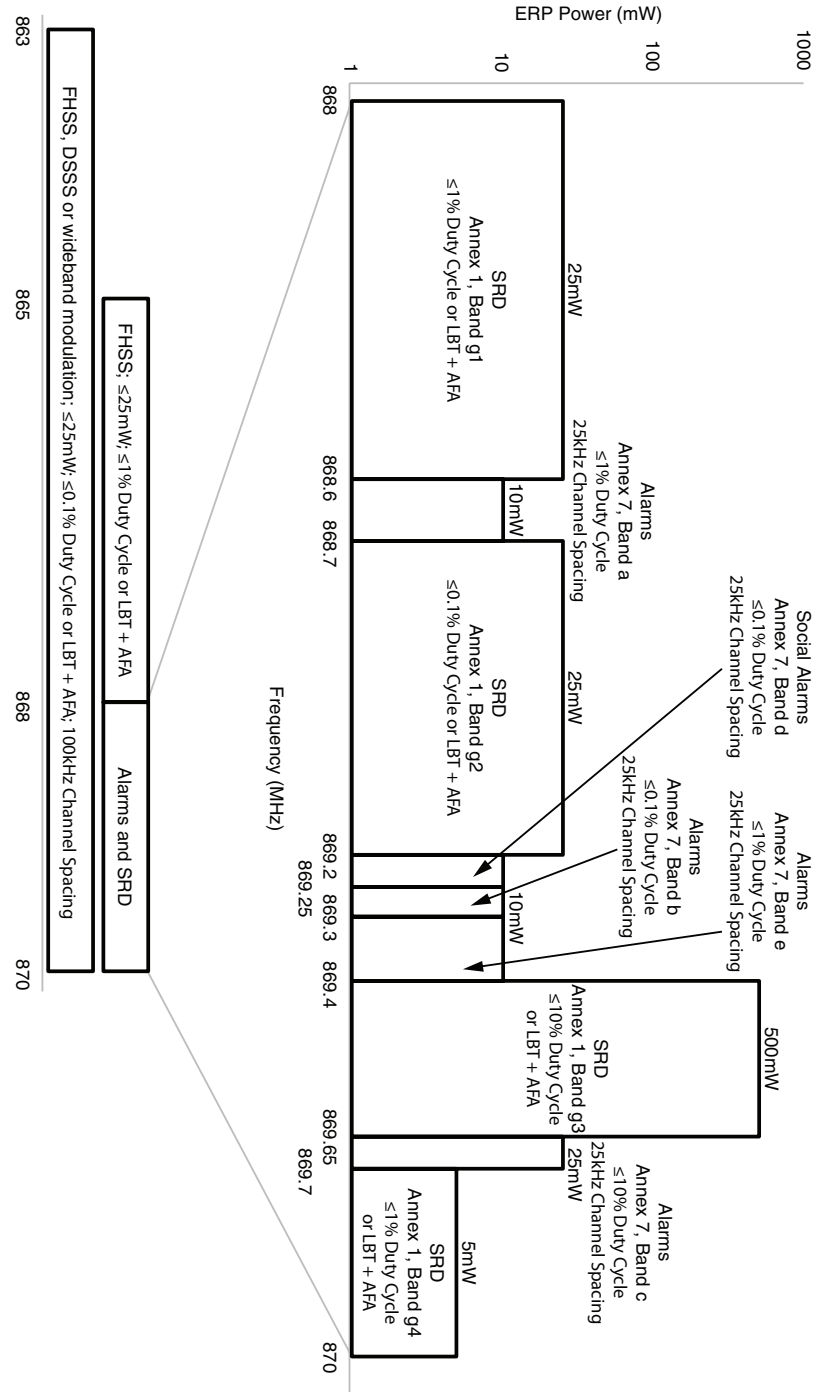

Figure 18: ERC Rec 70-03 868MHz Band Plan

GPIO Configuration

The module has 8 General Purpose Input / Output lines that can be configured and controlled through the Command Data Interface. They can be set in one of three ways.

- Digital Input - can be queried to see if the line is logical high or low.
- Digital Output - can be set to either logical high or low.
- Analog Input - connected to an internal Analog to Digital Converter (ADC). This provides a digital number that is proportional to the voltage on the line referenced to V_{CC} (0V to VCC range, 12 bits resolution).

Digital input lines have an internal pull-up to V_{CC} of approximately 20kOhm by default. The digital inputs can be configured to have either pull up or pull down resistors or be tri-state to fit different user hardware implementations.

Please see the Command Data Interface section for details on how to configure the GPIO settings.

Baud Rate

The module supports multiple serial baud rates on the UART for the Command Data Interface. The module uses the serial rate that is selected to automatically select one of its four RF baud bands. These baud bands determine the internal filter settings and the over-the-air data rate. Figure 19 shows the serial baud rate and the resulting baud band and RF baud rate.

Baud Rate Configuration		
Serial Baud Rate (kbps)	RF Baud Band	RF Baud Rate (kbps)
1.2	0	26
2.4	0	26
4.8	0	26
9.6	0	26
14.4	1	80
19.2	1	80
28.8	1	80
38.4	1	80
57.6	2	250
115.2	2	250
reserved	3	500

Figure 19: Baud Rate Configuration

Using the Low Power Features

The module supports several low-power features to save current in battery powered applications. Only EDs can use the low power states. APs and REs must be fully powered.

Taking the Power Down ($\overline{\text{POWER_DOWN}}$) line low places the module into the lowest power state. In this mode, the internal voltage regulator and all oscillators are turned off. All circuits powered from voltage regulator are also off. All GPIO lines retain the mode and output value set before entering power down. The module is not functional while in this mode and current consumption drops to about 0.3 μ A. Taking the line high wakes the module.

In Sleep, only the radio is powered down while all of the processor functions are still active. This has higher current consumption than power down, but leaves the processor able to perform functions, such as monitoring the GPIO lines. This state is controlled by a serial command.

In Idle, the receiver is disabled while processor is still running. The module switches to transmit mode when it has data to send. This state is controlled by a serial command.

External Amplifier Control

The HumDT™ Series transceiver has two output lines that are designed to control external amplifiers. The PA_EN line goes high when the module enters transmit mode. This can be used to activate an external power amplifier to boost the signal strength of the transmitter. The LNA_EN line goes high when the module enters receive mode. This can be used to activate an external low noise amplifier to boost the receiver sensitivity. These external amplifiers can significantly increase the range of the system at the expense of higher current consumption and system cost.

Encryption

The module implements AES encryption in ECB mode. The packet header information is sent in the clear and the payload data is encrypted.

Encryption algorithms are complex mathematical equations that use a number, called a key, to encrypt data before transmission. This is done so that unauthorized persons who may intercept the transmission cannot access the data. In order to decrypt the transmission, the receiver must use the same key that was used to encrypt it. The receiver performs the same calculations as the encoder and, if the key is the same, recovers the data.

The AES encryption algorithm is widely used, from basic wireless data links to Internet traffic to government communications. It is considered highly secure and reliable. The AES algorithm supports key lengths of 128, 192 and 256 bits. The HumDT™ module only supports 128 bits. The larger key lengths are more subject to government import and export regulations, though the user will need to confirm that 128 bits is allowable in their industry.

The strength of the encryption algorithm and the length of the key are only two factors in a secure system. The ultimate requirement is the secrecy of the key. The HumDT™ module only allows the key to be read out of the Access Point. It can be written into an End Device, but is otherwise inaccessible.

The AP should be kept in a secure location to prevent physical access by unauthorized persons. If the key is stored outside the system, such as in a database or list, then it should also be kept secure.

Restore Factory Defaults

The transceiver is reset to factory default with a serial command through the Command Data Interface. This command restores all of the configurations to factory default settings. These are shown in Figure 20.

Factory Default Configurations	
Parameter	Default Value
Device Type	ED
Module Address	0x00-0x00-0x00-0x00
Serial Baud Rate	9.6kbps
Channel Mapping	Single Channel (911.5MHz)
TX Output Power	0dBm
Network ID	0x00-0x00-0x00-0x00
All GPIOs	Digital Input with Pull-up
AES Key	0x2B, 0x7E, 0x15, 0x16, 0x28, 0xAE, 0xD2, 0xA6, 0xAB, 0xF7, 0x15, 0x88, 0x09, 0xCF, 0x4F, 0x3C

Figure 20: HumDT™ Factory Default Configurations

The module address is not changed to the factory default. This value is retained. This serial command requires knowing the current serial baud rate. If that is not known then all 10 supported rates should be tried to find out which is correct.

Command Data Interface

The DT Series transceiver has a serial Command Data Interface (CDI) that is used to configure and control the transceiver through software commands. This interface consists of a standard UART with a serial command set. The CMD_DATA_IN and CMD_DATA_OUT lines are the interface to the module's UART. The UART is configured for 1 start bit, 1 stop bit, 8 data bits, no parity and no flow control.

The general serial command format for the module is:

[Start Delimiter] [Command] [Parameters] [Data] [End Delimiter]

The Start Delimiter has a fixed value of 0x3C (the '<' ASCII character).

The Command codes are shown in Figure 21. The Command Data Interface Command Set section goes into the commands in detail.

The Data field is only available with the Send Data Packet and Send Broadcast Packet commands. This is the data that is transmitted over the air. The maximum number of data bytes in one data packet is 32 bytes.

The End Delimiter has a fixed value of 0x3E (the '>' ASCII character).

If a command sent to the module is successful, a response is returned. The general serial command response format is:

[Start Delimiter] [Response] [Parameters] [End Delimiter]

The Start Delimiter has a fixed value of 0x3C (the '<' ASCII character).

The Response Type code for each command is the same as the Command Type code. All the available Command Types are shown in Figure 21.

The Response Parameters for each type of response are detailed in the Command Data Interface Command Set section along with the corresponding command.

The End Delimiter has a fixed value of 0x3E (the '>' ASCII character).

All values are in hexadecimal format.

CDI Command Codes			
Command Code (hex)	Parameters (bytes)	Data (bytes)	Command Type Definition
21	6	0–32	Send Data Packet
22	0	0	Read Non-volatile Configurations
23	54	0	Write Non-volatile Configurations
24	2	0	Read I/O Configurations
26	2	0	Read Analog Voltage Value
27	2	0	Read Digital IO Value
28	3	0	Write Digital Output Value
29	0	0	Read Channel Number
2A	1	0	Write Channel Number
2B	0	0	Read TX Power Level
2C	1	0	Write TX Power Level
2D	0	0	Read Radio State
2E	1	0	Write Radio State
2F	0	0	Read Ambient RSSI
30	0	0	Restore Factory Default Configurations
31	0	0	Read Device Name
32	0	0	Read Firmware Version
33	0	0	Read Module Serial Number
39	1	0–32	Send Broadcast Packet
3A	0	0	Read Associated Modules
3B	4	0	Delete Associated Module
3C	0	0	Reset Module
3D	0	0	Read Associated Module Count
42	1	0	CW Signal
43	0	0	Read AES Key
44	16	0	Write AES Key
7A	1	0	Initialization Complete Message

Figure 21: HumDT™ CDI Command Codes

The Command Data Interface Command Set

The following sections describe the commands and parameters.

Note: All values are shown in hexadecimal format unless otherwise stated.

The module has two forms of memory, volatile and non-volatile. Volatile memory is temporary and all values are lost when power is removed from the module. However, it is faster to access and the module typically uses the values in volatile memory during operation.

Non-volatile memory is retained when power is removed from the module. This is where default values are stored. When the module powers on, it pulls some values from non-volatile memory and loads them into volatile memory for use during normal operation.

There is one command to read (Command Code = 22) and one command to write (Command Code = 23) all of the configurations in non-volatile memory. The non-volatile memory has a life expectancy of about 1,000 writes, so using one command for all settings helps extend the life time.

Volatile settings have separate commands for each setting since it has a much larger life expectancy. This makes it easier to change just one configuration value.

Send Data Packet - Command Code = 21

This command instructs the module to transmit a data packet over the air.

Send Data Packet Command and Response								
Command								
Start	Cmd	Param 1	Param 2	Param 3	Param 4	Param 5	Data	End
3C	21	DestAdr3	DestAdr2	DestAdr1	DestAdr0	LEN	DATA	3E
Response								
Start	Rsp	Param1	End					
3C	21	Status	3E					

Figure 22: Send Data Packet Command and Response

The first four bytes consist of the destination address for the data packet with the DestAdr3 (Param 1 byte) being the Most Significant Byte (MSB). The Len byte (Param 5) is the total number of bytes in the Parameter and Data fields (5 bytes plus the number of data bytes).

The Data field contains 0 to 32 bytes of user defined data.

The response parameter indicates if the module successfully processed the command (0x00) or if there was an error (0x01). It only indicates that the data packet has been successfully transmitted by module. It does not indicate that the data was successfully received by the remote device.

When data is received by the module, the output format follows the same format with two exceptions. The source address (address of the transmitting module) replaces the destination address and the module adds one or two RSSI bytes to the end of the response.

The RSSI values depend on the number of hops the packet took. From AP to ED is one hop and only one RSSI byte is added. Transmissions from one ED to another ED must go through the AP, so there are two hops. RSSI1 is the first hop, RSSI2 is the second hop. There is no placeholder, so RSSI2 is either there or not.

The LEN byte includes the Parameter, Data and RSSI bytes.

Received Data Packet Output										
Start	Cmd	Param 1	Param 2	Param 3	Param 4	Param 5	Data	RSSI1	RSSI2	End
3C	20	SrcAdr3	SrcAdr2	SrcAdr1	SrcAdr0	LEN	DATA	RSSI1	RSSI2	3E

Figure 23: Received Data Packet CDI Output

The RSSI value is returned in 2's complement hex format. The RSSI value in dBm can be calculated based on the formula shown below.

$$\text{RSSI (dBm)} = \text{RSSI_value (in the response)} - 256$$

Read Non-volatile Configurations - Command Code = 22

This command reads all of the configurations that are stored in the module's non-volatile memory.

Read Non-volatile Configurations Command and Response					
Command					
Start	Command	End			
3C	22	3E			
Response					
Start	Response	Param 1	...	Param 55	End
3C	22	DType	...	Status	3E

Figure 24: Read Non-volatile Configurations Command and Response

The response contains 55 bytes of configuration parameters. The full list of parameters are shown in Figure 25 followed by descriptions of each one.

Note that this command reads out the configurations stored in non-volatile memory. Any configurations that have been changed in volatile memory are not read by this command.

Parameter 1 is the device type. This indicates whether the module is acting as an Access Point (31), Range Extender (32) or End Device (33).

Parameters 2 through 4 are the module's local address that uniquely identifies it within the network. No other module in the same network can have the same address.

Parameter 6 is the UART serial baud rate. The codes for this are shown in Figure 26.

Parameter 7 configures the default channel number. The channels are shown in Figure 17.

Parameter 9 controls the transmitter output power level. Figure 27 shows the power level codes and the approximate output power. The actual output power may differ slightly from part-to-part.

Parameters 10 through 13 set the ID of the network that the module is to join. Other modules respond only if they have this same network ID.

Module Configuration Parameters			
Param #	Definition	Description	Default Value
1	Device Type	AP (0x31); RE (0x32); ED (0x33)	0x33
2	Module Address [3]	Module Local Address (MSB)	0x00
3	Module Address [2]	Module Local Address (2nd bytes)	0x00
4	Module Address [1]	Module Local Address (3rd byte)	0x00
5	Module Address [0]	Module Local Address (LSB)	0x00
6	Baud Rate	Baud Rate Code (default 9.6 kbps)	0x03
7	Default Channel	Default Channel number	0x1E
8	Reserved	N/A	0x00
9	TX Power Level	The TX output power level code	0x05
10	Network ID [3]	Network ID for the module (MSB)	0x00
11	Network ID [2]	Network ID for the module (2nd byte)	0x00
12	Network ID [1]	Network ID for the module (3rd byte)	0x00
13	Network ID [0]	Network ID for the module (LSB)	0x00
14	Port 0; A/D	A/D config for GPIO lines (Analog=1; Digital=0)	0x00
15	Port 0; I/O	I/O config for GPIO lines (Output=1; Input=0)	0x00
16	Reserved	N/A	0x0B
17	Reserved	N/A	0x00
18	Reserved	N/A	0x00
19	Pull-up / Pull-down	PU / PD config for GPIO lines (PU=0; PD=1)	0x00
20	Tristate	Tristate config for GPIO lines (PUD=0; Tri=1)	0x00
21	AES Key [15]	MSB of AES key	0x2B
22	AES Key [14]	2nd byte of AES key	0x7E
23	AES Key [13]	3rd byte of AES key	0x15
24	AES Key [12]	4th byte of AES key	0x16
25	AES Key [11]	5th byte of AES key	0x28
26	AES Key [10]	6th byte of AES key	0xAE
27	AES Key [9]	7th byte of AES key	0xD2
28	AES Key [8]	8th byte of AES key	0xA6
29	AES Key [7]	9th byte of AES key	0xAB
30	AES Key [6]	10th byte of AES key	0xF7
31	AES Key [5]	11th byte of AES key	0x15
32	AES Key [4]	12th byte of AES key	0x88
33	AES Key [3]	13th byte of AES key	0x09
34	AES Key [2]	14th byte of AES key	0xCF
35	AES Key [1]	15th byte of AES key	0x4F
36	AES Key [0]	LSB of AES key	0x3C
37	Reserved	N/A	0x00
38	Reserved	N/A	0x00
39	Reserved	N/A	0x00
40	Reserved	N/A	0x00
41	Reserved	N/A	0x00
42	Reserved	N/A	0x00
43	Reserved	N/A	0x00
44	Reserved	N/A	0x00
45	Reserved	N/A	0x00
46	Reserved	N/A	0x00
47	Reserved	N/A	0x00
48	Reserved	N/A	0x00
49	Reserved	N/A	0x00
50	Reserved	N/A	0x00
51	Reserved	N/A	0x00
52	Reserved	N/A	0x00
53	Reserved	N/A	0x00
54	Reserved	N/A	0x00
55	Status	Indicates if the command is successful (0) or not (1)	0x00 (no error)

Figure 25: Read Non-volatile Configurations Response Parameters

Baud Rate Codes	
Serial Baud Rate (kbps)	Baud Rate Code
1.2	0
2.4	1
4.8	2
9.6	3
14.4	4
19.2	5
28.8	6
38.4	7
57.6	8
115.2	9
reserved	N/A

Figure 26: Baud Rate Codes

Transmitter Output Power Codes	
Power Level Code	HUM-868-DT TX Output Power (dBm)
00	-30
01	-20
02	-15
03	-10
04	-5
05	0
06	5
07	7
08	10

Figure 27: Transmitter Output Power Codes

Parameter 14 configures the GPIO lines to be either analog or digital. The byte is a bit map with each bit corresponding to a single line; bit 0 corresponds to GPIO_0 and bit 7 corresponds to GPIO_7. Setting a bit to 0 makes that GPIO line digital and setting it to 1 makes the line analog.

Parameter 15 configures the GPIO lines to be either inputs or outputs. The byte is a bit map with each bit corresponding to a single line; bit 0 corresponds to GPIO_0 and bit 7 corresponds to GPIO_7. Setting a bit to 0 makes that GPIO line an input and setting it to 1 makes the line an output. Note that analog lines can only be inputs.

Parameter 19 configures the GPIO lines to have either pull-up resistors to V_{CC} or pull-down resistors to ground. If this byte is set to 0 then all of the GPIO lines have pull-up resistors. Any non-zero value configures the GPIO lines to have pull-down resistors. Note that the tri-state configurations in Parameter 20 take precedence over the resistors. If a line is configured to be tri-state then the resistors are not used.

Parameter 20 configures the GPIO digital input lines to either use the pull-up and pull-down resistors or to be tri-state. The byte is a bit map with each bit corresponding to a single line; bit 0 corresponds to GPIO_0 and bit 7 corresponds to GPIO_7. Setting a bit to 0 makes that GPIO line use the pull-up / pull-down resistors as configured by Parameter 19. Setting it to 1 makes the line tri-state, which is essentially having no resistors.

Setting an input to tri-state deactivates the resistors. This reduces the overall current consumption by removing the current draw through the 20k Ω pulling resistors. However, input lines set as tri-state must be in a determined state (high or low). They cannot be left floating or unpredictable operation may occur.

Parameters 21 through 36 contain the 128-bit key for the AES encryption algorithm. This key must be the same as all other modules on the network.

Parameter 55 indicates if the read command was successful (00) or if there was an error (01).

Write Non-volatile Configurations - Command Code = 23

This command writes all of the configurations that are stored in the module's non-volatile memory.

Write Non-volatile Configurations Command and Response					
Command					
Start	Command	Param 1	...	Param 54	End
3C	23	DType	...	Rsv	3E
Response					
Start	Response	Param 1	End		
3C	23	Status	3E		

Figure 28: Write Non-volatile Configurations Command and Response

This command follows the Parameters shown in Figure 25 with the exception of Parameter 55. That byte is a read-only and is not included in the Write command.

Once written, the non-volatile configurations can be read out immediately. A power cycle is required for them to take effect.

The module uses the values in volatile memory during operation. The module loads the values from non-volatile to volatile memory when it initializes after power-up, so a power cycle is necessary for the module to use the new values.

Read I/O Configurations - Command Code = 24

This command reads the configurations of a specific GPIO line from volatile memory.

Read I/O Configurations Command and Response							
Command							
Start	Command	Param 1	Param 2	End			
3C	24	00	GPIO	3E			
Response							
Start	Response	Param 1	Param 2	Param 3	Param 4	Param 5	End
3C	24	00	GPIO	ADCfg	IOCfg	Status	3E

Figure 29: Read I/O Configurations Command and Response

Parameter 1 is set to 0x00. Parameter 2 is the GPIO number to be queried, where 0 corresponds to GPIO_0 and 7 is GPIO_7 and so forth.

The response returns five parameter bytes. Parameter 1 is set to 0x00 and Parameter 2 returns the GPIO number that is being read. Parameter 3 returns the Analog / Digital configuration (digital = 0, analog = 1) and Parameter 4 returns the Input / Output configuration (input = 0, output = 1).

Parameter 5 indicates if the read command was successful (00) or if there was an error (01).

Read Analog Voltage Value - Command Code = 26

This command reads the analog voltage on a specific GPIO line.

Read Analog Voltage Value Command and Response							
Command							
Start	Command	Param 1	Param 2	End			
3C	26	00	GPIO	3E			
Response							
Start	Response	Param 1	Param 2	Param 3	Param 4	Param 5	End
3C	26	00	GPIO	ADC1	ADC2	Status	3E

Figure 30: Read Analog Voltage Value Command and Response

Parameter 1 is set to 0x00. Parameter 2 is the GPIO number to be queried, where 0 corresponds to GPIO_0 and 7 is GPIO_7 and so forth.

The response returns four parameter bytes. Parameter 1 is set to 0x00 and Parameter 2 returns the GPIO number that is being read. Param 3 and Param 4 return the voltage value on the pin. The voltage on the pin is calculated using the formula below.

$$\text{Voltage (V)} = [(Param 3) * 16 + (Param 4)] / 2047 * V_{CC}$$

For example, if a Read ADC Value command returns the following response and V_{CC} is 3.0V,

0x3C 0x26 0x00 0x07 0x21 0x0E 0x00 0x3E

This means that the voltage on GPIO_7 can be calculated as

$$[(0x21) * 16 + (0x0E)] / 2047 * 3.0 = 0.794V$$

The GPIO line being read must be configured as an analog input before the ADC value can be read.

Parameter 5 indicates if the command was successful (00) or if there was an error (01).

Read Digital IO Value - Command Code = 27

This command reads the digital input value on a specific GPIO line.

Read Digital Input Value Command and Response						
Command						
Start	Command	Param 1	Param 2	End		
3C	27	00	GPIO	3E		
Response						
Start	Response	Param 1	Param 2	Param 3	Param 4	End
3C	27	00	GPIO	DIVal	Status	3E

Figure 31: Read Digital Input Value Command and Response

This command returns four Parameter bytes. Parameter 1 is set to 0x00 and Parameter 2 returns the GPIO number that is being read.

Parameter 3 is the state of the GPIO line that is being read. If it is high, Parameter 3 is 0x01. If it is low, Parameter 3 is 0x00.

Parameter 4 indicates if the command was successful (00) or if there was an error (01).

The GPIO line being read must be configured as a digital input or output before the value can be read.

Write Digital Output Value - Command Code = 28

This command sets the digital output value on a specific GPIO line.

Write Digital Outputs Command and Response					
Command					
Start	Command	Param 1	Param 2	Param 3	End
3C	28	00	GPIO	DOVal	3E
Response					
Start	Response	Param 1	End		
3C	28	Status	3E		

Figure 32: Write Digital Outputs Value Command and Response

Parameter 1 is set to 0x00 and Parameter 2 is the GPIO number that is being written. Parameter 3 sets the output state (High = 01; Low = 00). The configuration made in volatile memory overwrites the configuration read from the non-volatile memory until a power reset.

The GPIO to be written must be configured as a digital output before the value can be written.

The response parameter indicates if the command was successful (00) or if there was an error (01).

Read Channel Number - Command Code = 29

This command reads the module's current channel number.

Read Channel Number Command and Response			
Command			
Start	Command	End	
3C	29	3E	
Response			
Start	Response	Param 1	End
3C	29	Chan	3E

Figure 33: Read Channel Number Command and Response

The channel number in the response ranges from 0x00 to 0x44. This value is stored in non-volatile memory.

Write Channel Number - Command Code = 2A

This command sets the channel number that is to be used by the module.

Write Channel Number Command and Response			
Command			
Start	Command	Param 1	End
3C	2A	Chan	3E
Response			
Start	Response	Param 1	End
3C	2A	Status	3E

Figure 34: Write Channel Number Command and Response

The response parameter indicates if the command was successful (00) or if there was an error (01).

Read TX Power Level - Command Code = 2B

This command reads the current TX output power level from RAM.

Read TX Power Level Command and Response			
Command			
Start	Command	End	
3C	2B	3E	
Response			
Start	Response	Param 1	End
3C	2B	TXPower	3E

Figure 35: Read TX Power Level Command and Response

The TX output power levels are shown in Figure 36. This command reads the TX output power level setting stored in volatile memory, which may be different from that stored in non-volatile memory.

Transmitter Output Power Codes	
Power Level Code	HUM-868-DT TX Output Power (dBm)
00	-30
01	-20
02	-15
03	-10
04	-5
05	0
06	5
07	7
08	10

Figure 36: Transmitter Output Power Codes

Write TX Power Level - Command Code = 2C

This command sets the TX output power level in volatile memory.

Write TX Power Level Command and Response			
Command			
Start	Command	Param 1	End
3C	2C	TXPower	3E
Response			
Start	Response	Param 1	End
3C	2C	Status	3E

Figure 37: Write TX Power Level Command and Response

The TX output power levels are shown in Figure 36. This command writes the TX output power level stored in volatile memory, which may be different from what is in non-volatile memory. This change is lost on a power cycle.

The response parameter indicates if the command was successful (00) or if there was an error (01).

Read Radio State - Command Code = 2D

This command reads the current radio state.

Read Radio State Command and Response			
Command			
Start	Command	End	
3C	2D	3E	
Response			
Start	Response	Param 1	End
3C	2D	RState	3E

Figure 38: Read Radio State Command and Response

The response returns the Radio State Code for the radio's current working state. The module can be in one of the five states shown in Figure 39.

Radio State Codes		
RState Code	Radio State	Description
0x00	Unknown	An error has happened
0x01	Sleep	The radio is in sleep mode (turned off).
0x02	Idle	The radio is turned on in an idle mode (neither TX nor RX)
0x03	RX On	The radio is in RX mode.
0x04	TX On	TX state is automatically entered when data is input to the module.

Figure 39: Radio State Codes

The Unknown state indicates an error has happened.

The Sleep state is a low-power state where the radio is powered off, but some microcontroller blocks are running.

The Idle state is a state where the RX section of the radio is turned off. However, the module can still switch to the TX On state when it has something to send. The microcontroller is running.

The RX On mode is where the radio is in receive mode and the microcontroller is running.

The TX On state is where the radio is in transmit mode and the microcontroller is running.

Write Radio State - Command Code = 2E

This command sets the current Radio State.

Write Radio State Command and Response			
Command			
Start	Command	Param 1	End
3C	2E	RState	3E
Response			
Start	Response	Param 1	End
3C	2E	Status	3E

Figure 40: Write Radio State Command and Response

This command places the module into one of the RState codes shown in Figure 41.

Radio State Codes		
RState Code	Radio State	Description
0x00	Awake	Wakes up the module from Sleep or Power Down and brings it to RX On
0x01	Sleep	Puts the radio into sleep state (turned off)
0x02	Idle	Sets the radio to idle state (neither TX nor RX)
0x03	RX On	Turns on the receiver, also wakes from Sleep
0x04	PDN	Puts the module into Power Down state

Figure 41: Radio State Codes

The module automatically enters the TX state when there is data to be transmitted by the radio. It cannot be manually controlled by issuing a serial command.

Only EDs can go into Sleep, power down and Idle. APs and REs must stay awake.

The response parameter indicates if the command was successful (00) or if there was an error (01).

Read Ambient RSSI - Command Code = 2F

This command reads the current RSSI value. This indicates how quiet the current ambient RF environment is.

Read Ambient RSSI Command and Response			
Command			
Start	Command	End	
3C	2F	3E	
Response			
Start	Response	Param 1	End
3C	2F	RSSI	3E

Figure 42: Read Ambient RSSI Command and Response

The RSSI value is returned in 2's complement hex format. The RSSI value in dBm can be calculated based on the formula shown below.

$$\text{RSSI (dBm)} = \text{RSSI_value (in the response)} - 256$$

This command only returns the ambient RSSI. The RSSI for a received packet is included with the packet data. The response is only valid when the radio state is set to RX On.

Restore Factory Default Configurations - Command Code = 30

This command restores all the configurations in the non-volatile memory back to the factory default values.

Restore Factory Default Configurations Command and Response			
Command			
Start	Command	End	
3C	30	3E	
Response			
Start	Response	Param 1	End
3C	30	Status	3E

Figure 43: Restore Factory Default Configurations Command and Response

Once this command is issued and all non-volatile settings have been restored, a power cycle restores all volatile settings to the factory defaults. The module now works as it was originally shipped. The one exception is that the module address is retained. This can be set to the default of 00 00 00 00 if desired.

The response parameter indicates if the command was successful (00) or if there was an error (01).

Read Device Name - Command Code = 31

This command returns the name of the module.

Read Device Name Command and Response					
Command					
Start	Command	End			
3C	31	3E			
Response					
Start	Response	Param 1	...	Param 11	End
3C	31	Name0	...	Name11	3E

Figure 44: Read Device Name Command and Response

The Device Name is "HUM-868-DT\0". The bytes that are output correspond to the ASCII values associated with the characters. They are terminated by a 00 control character. For example, the response is:

3C 31 48 55 4D 2D 38 36 38 2D 44 54 00 3E

Read Firmware Version - Command Code = 32

This command reads out the module's firmware version.

Read Firmware Version Command and Response						
Command						
Start	Command	End				
3C	32	3E				
Response						
Start	Response	Param 1	Param 2	Param 3	Param 4	End
3C	32	FW3	FW2	FW1	FW0	3E

Figure 45: Read Firmware Version Command and Response

FW3 is the MSB and FW0 is the LSB in the number.

Read Module Serial Number - Command Code = 33

This command reads out the module's serial number.

Read Module Serial Number Command and Response						
Command						
Start	Command	End				
3C	33	3E				
Response						
Start	Response	Param 1	Param 2	Param 3	Param 4	End
3C	33	SN3	SN2	SN1	SN0	3E

Figure 46: Read Module Serial Number Command and Response

The serial number is set at the factory and cannot be changed. Every DT Series module manufactured by Linx has a unique serial number. This is different from the module address. SN3 is the MSB and SN0 is the LSB in the number.

Send Broadcast Packet - Command Code = 39

This command is used by an AP to send a broadcast message to all of its associated EDs at one time.

Send Broadcast Packet Command and Response				
Command				
Start	Command	Param 1	Param 2	End
3C	39	LEN	DATA	3E
Response				
Start	Response	Param 1	End	
3C	39	Status	3E	

Figure 47: Send Broadcast Packet Command and Response

The LEN byte is the number of bytes in the DATA field plus 1 for the LEN byte. DATA can be up to 32 bytes.

The broadcast message is sent by the AP and is output by all of the EDs connected to the AP. This allows a single transmission to update all modules instead of having to address separate messages to each one.

The response parameter indicates if the command was successful (00) or if there was an error (01).

The EDs output the broadcast message as shown in Figure 48.

Received Broadcast Packet					
Start	Command	Param 1	Param 2	Param 3	End
3C	39	LEN	DATA	RSSI	3E

Figure 48: Received Broadcast Packet

The LEN byte is the total number of parameter bytes, including the LEN byte, data bytes and RSSI byte.

The DATA field is up to 32 bytes of data.

The RSSI byte is the RSSI for the received broadcast message. It is returned in 2's complement hex format. The RSSI value in dBm is calculated the same as the other RSSI values.

$$\text{RSSI (dBm)} = \text{RSSI_value (in the response)} - 256$$

Read Associated Modules - Command Code = 3A

This command reads out all of the modules that are associated with the current module.

Read Associates List Command and Response						
Command						
Start	Command	End				
3C	3A	3E				
Response 1						
Start	Response	Param 1	End			
3C	3A	NumMod	3E			
Response 2						
Start	Response	Param 1	Param 2	Param 3	Param 4	End
3C	3A	SrcAdr3	SrcAdr2	SrcAdr1	SrcAdr0	3E
...						
Response n						
Start	Response	Param 1	Param 2	Param 3	Param 4	End
3C	3A	SrcAdr3	SrcAdr2	SrcAdr1	SrcAdr0	3E

Figure 49: Read Associates List Command and Response

If the current module is an ED or RE, then the only associated node is the AP. An AP can have up to 50 associated EDs in a single network. Due to the lack of intelligence in an RE, this command does not provide the RE information.

The first response contains the number of modules associated with the current module. The module then outputs one response for each associated module that contains that module's address.

Delete Associated Module - Command Code = 3B

This command removes the association between the current module and another module.

Delete Associated Module Command and Response						
Command						
Start	Command	Param 1	Param 2	Param 3	Param 4	End
3C	3B	SrcAdr3	SrcAdr2	SrcAdr1	SrcAdr0	3E
Response						
Start	Response	Param 1	End			
3C	3B	Status	3E			

Figure 50: Delete Associated Module Command and Response

Associated modules can only be removed one by one using this command. Once a module is deleted, the AP cannot communicate with the ED until a new link is established and the modules become associated again. This requires a power cycle or a reset on the ED. The parameters of this command contain the address of the module to be deleted, where SrcAdr3 is the MSB and SrcAdr0 is the LSB.

The response parameter indicates if the command was successful (00) or if there was an error (01).

Reset Module - Command Code = 3C

This command initiates a full module reset.

Reset Module Command and Response			
Command			
Start	Command	End	
3C	3C	3E	
Response			
Start	Response	Param 1	End
3C	3C	Status	3E

Figure 51: Reset Module Command and Response

This serial command is the equivalent of pulling the $\overline{\text{RESET}}$ line low.

Read Associated Module Count - Command Code = 3D

This command reads the total number of modules associated with the current module.

Read Associated Module Count Command and Response			
Command			
Start	Command	End	
3C	3D	3E	
Response			
Start	Response	Param 1	End
3C	3D	Count	3E

Figure 52: Read Associated Module Count Command and Response

For an ED, the only associated module is the AP, so the count will always be 1. An AP outputs the number of EDs associated with it. The lack of intelligence in an RE prevents it from being counted. An RE always outputs a 0 because it lacks the intelligence to store its associated AP.

Output CW Signal - Command Code = 42

This command instructs the module to output an unmodulated CW signal. This can be useful during testing for regulatory compliance.

Output CW Signal Command and Response				
Command				
Start	Command	Param 1	Param 1	End
3C	42	Chan	TXPower	3E
Response				
Start	Response	Param 1	End	
3C	42	Status	3E	

Figure 53: Output CW Signal Command and Response

The module should be configured as an End Device before issuing this command.

Chan is the channel number to be used. It ranges from 0 to 68 decimal except number 65. Figure 17 shows the channel numbers and frequencies.

TXPower is the power level of the signal. The power codes are shown in Figure 27.

The response parameter indicates if the command was successful (00) or if there was an error (01).

This command takes the module out of the communication stack so a reset is required to bring the module back to normal operation.

Read AES Key - Command Code = 43

This command reads out the AES key currently being used by the module. This can only be read out if the module is an Access Point. It cannot be read out of End Devices or Range Extenders.

Read AES Key Command and Response					
Command					
Start	Command	End			
3C	43	3E			
Response					
Start	Response	Param 1	...	Param 16	End
3C	43	KeyMSB	...	KeyLSB	3E

Figure 54: Read AES Key Command and Response

This reads out the key in volatile memory, which is what is currently being used to encrypt packets. This can be different from what is in non-volatile memory if the Write AES Key command has been used to change it.

If an error occurs, such as trying to read the key from an ED, the response is 3C 43 01 3E.

Write AES Key - Command Code = 44

This command writes the AES key into the module's volatile memory. This key is used to encrypt packets as soon as the write is completed.

Write AES Key Command and Response					
Command					
Start	Command	Param 1	...	Param 16	End
3C	44	KeyMSB	...	KeyLSB	3E
Response					
Start	Response	Param 1	End		
3C	44	Status	3E		

Figure 55: Write AES Key Command and Response

The key is written MSB first. The response parameter indicates if the command was successful (00) or if there was an error (01).

Read Module Temperature - Command Code = 47

This command reads out the value from the module's internal temperature sensor.

Read Module Temperature Command and Response					
Command					
Start	Command	End			
3C	47	3E			
Response					
Start	Response	Param 1	Param 2	Param 3	End
3C	47	TempH	TempL	Status	3E

Figure 56: Read Module Temperature Command and Response

The temperature in degrees Celsius is calculated with the following formula.

$$T = \frac{((TempH \times 16) + TempL) \times 1250}{2047} - 755}{2.54}$$

For example, if the module returns TempH = 0x54 and TempL = 0x09 then:

$$T = \{[(0x54 \times 16) + 0x09] \times 1250 / 2047 - 755\} / 2.54 = 28.035^{\circ}\text{C}$$

The Status parameter indicates if the command was successful (00) or if there was an error (01).

Initialization Complete Message - Response Code = 7A

Once the module has completed its power-up initialization routines and joined the network, it outputs the message shown in Figure 57.

Initialization Complete Message			
Start	Response	Param 1	End
3C	7A	DType	3E

Figure 57: Initialization Complete Message

The DType parameter is the device type that the module has assumed during initialization. These codes are shown in Figure 58.

Device Type Codes	
Device Type	Device Type Code (hex)
Access Point (AP)	31
Range Extender (RE)	32
End Device (ED)	33

Figure 58: Baud Rate Codes

The microcontroller can confirm that this is the correct device type for the application and make changes as necessary.

Typical Applications

Figure 59 shows a typical circuit using the HumDT™ Series transceiver.

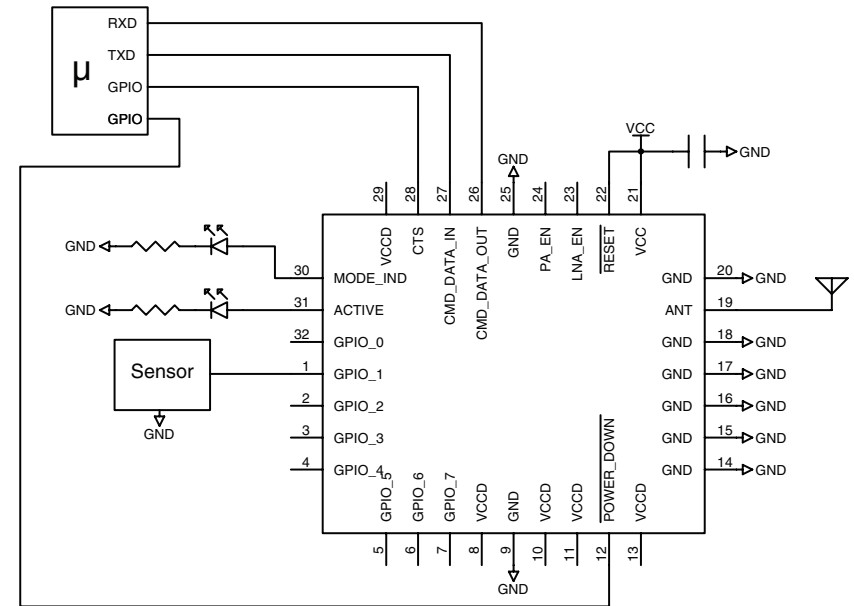

Figure 59: HumDT™ Series Transceiver Basic Application Circuit

An external microcontroller provides data and configuration commands. It also controls the `POWER_DOWN` line to place the module into a low power state.

A sensor is connected to `GPIO_1`. This sensor outputs an analog voltage that is proportional to the parameter being measured. `GPIO_1` is set as an analog input and the microcontroller can query the voltage state of the line.

The `VCCD` lines are not connected in this example. These lines are unused inputs with 20k resistors to `VCC`. They should be connected directly to `VCC` if noise on the board or in the environment could cause voltage drops on the lines that fall below the `VIH` specification. This is not likely to be an issue with most battery-powered devices, but could be a problem with designs containing switching power supplies or used near motors or other sources of high-level EMI. This should be tested with all designs.

Power Supply Requirements

The module does not have an internal voltage regulator, therefore it requires a clean, well-regulated power source. The power supply noise should be less than 20mV. Power supply noise can significantly affect the module's performance, so providing a clean power supply for the module should be a high priority during design.

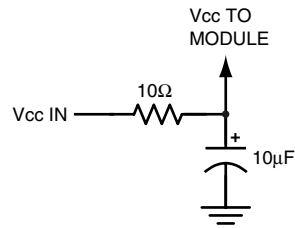

Figure 60: Supply Filter

A 10Ω resistor in series with the supply followed by a 10μF tantalum capacitor from V_{cc} to ground helps in cases where the quality of supply power is poor (Figure 60). This filter should be placed close to the module's supply lines. These values may need to be adjusted depending on the noise present on the supply line.

Antenna Considerations

The choice of antennas is a critical and often overlooked design consideration. The range, performance and legality of an RF link are critically dependent upon the antenna. While adequate antenna performance can often be obtained by trial and error methods, antenna design and matching is a complex task. Professionally designed antennas such as those from Linx (Figure 61) help ensure maximum performance and FCC and other regulatory compliance.



Figure 61: Linx Antennas

Linx transmitter modules typically have an output power that is higher than the legal limits. This allows the designer to use an inefficient antenna such as a loop trace or helical to meet size, cost or cosmetic requirements and still achieve full legal output power for maximum range. If an efficient antenna is used, then some attenuation of the output power will likely be needed.

It is usually best to utilize a basic quarter-wave whip until your prototype product is operating satisfactorily. Other antennas can then be evaluated based on the cost, size and cosmetic requirements of the product. Additional details are in Application Note AN-00500.

Helpful Application Notes from Linx

It is not the intention of this manual to address in depth many of the issues that should be considered to ensure that the modules function correctly and deliver the maximum possible performance. We recommend reading the application notes listed in Figure 62 which address in depth key areas of RF design and application of Linx products. These applications notes are available online at www.linxtechnologies.com or by contacting the Linx literature department.

Helpful Application Note Titles

Note Number	Note Title
AN-00100	RF 101: Information for the RF Challenged
AN-00126	Considerations for Operation Within the 902–928MHz Band
AN-00130	Modulation Techniques for Low-Cost RF Data Links
AN-00140	The FCC Road: Part 15 from Concept to Approval
AN-00500	Antennas: Design, Application, Performance
AN-00501	Understanding Antenna Specifications and Operation

Figure 62: Helpful Application Note Titles

Interference Considerations

The RF spectrum is crowded and the potential for conflict with unwanted sources of RF is very real. While all RF products are at risk from interference, its effects can be minimized by better understanding its characteristics.

Interference may come from internal or external sources. The first step is to eliminate interference from noise sources on the board. This means paying careful attention to layout, grounding, filtering and bypassing in order to eliminate all radiated and conducted interference paths. For many products, this is straightforward; however, products containing components such as switching power supplies, motors, crystals and other potential sources of noise must be approached with care. Comparing your own design with a Linx evaluation board can help to determine if and at what level design-specific interference is present.

External interference can manifest itself in a variety of ways. Low-level interference produces noise and hashing on the output and reduces the link's overall range.

High-level interference is caused by nearby products sharing the same frequency or from near-band high-power devices. It can even come from your own products if more than one transmitter is active in the same area. It is important to remember that only one transmitter at a time can occupy a frequency, regardless of the coding of the transmitted signal. This type of interference is less common than those mentioned previously, but in severe cases it can prevent all useful function of the affected device.

Although technically not interference, multipath is also a factor to be understood. Multipath is a term used to refer to the signal cancellation effects that occur when RF waves arrive at the receiver in different phase relationships. This effect is a particularly significant factor in interior environments where objects provide many different signal reflection paths. Multipath cancellation results in lowered signal levels at the receiver and shorter useful distances for the link.

Pad Layout

The pad layout diagram in Figure 63 is designed to facilitate both hand and automated assembly.

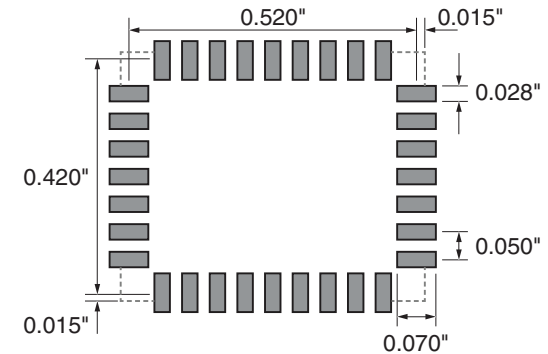

Figure 63: Recommended PCB Layout

Board Layout Guidelines

The module's design makes integration straightforward; however, it is still critical to exercise care in PCB layout. Failure to observe good layout techniques can result in a significant degradation of the module's performance. A primary layout goal is to maintain a characteristic 50-ohm impedance throughout the path from the antenna to the module. Grounding, filtering, decoupling, routing and PCB stack-up are also important considerations for any RF design. The following section provides some basic design guidelines.

During prototyping, the module should be soldered to a properly laid-out circuit board. The use of prototyping or "perf" boards results in poor performance and is strongly discouraged. Likewise, the use of sockets can have a negative impact on the performance of the module and is discouraged.

The module should, as much as reasonably possible, be isolated from other components on your PCB, especially high-frequency circuitry such as crystal oscillators, switching power supplies, and high-speed bus lines.

When possible, separate RF and digital circuits into different PCB regions.

Make sure internal wiring is routed away from the module and antenna and is secured to prevent displacement.

Do not route PCB traces directly under the module. There should not be any copper or traces under the module on the same layer as the module, just bare PCB. The underside of the module has traces and vias that could short or couple to traces on the product's circuit board.

The Pad Layout section shows a typical PCB footprint for the module. A ground plane (as large and uninterrupted as possible) should be placed on a lower layer of your PC board opposite the module. This plane is essential for creating a low impedance return for ground and consistent stripline performance.

Use care in routing the RF trace between the module and the antenna or connector. Keep the trace as short as possible. Do not pass it under the module or any other component. Do not route the antenna trace on multiple PCB layers as vias add inductance. Vias are acceptable for tying together ground layers and component grounds and should be used in multiples.

Each of the module's ground pins should have short traces tying immediately to the ground plane through a via.

Bypass caps should be low ESR ceramic types and located directly adjacent to the pin they are serving.

A 50-ohm coax should be used for connection to an external antenna. A 50-ohm transmission line, such as a microstrip, stripline or coplanar waveguide should be used for routing RF on the PCB. The Microstrip Details section provides additional information.

In some instances, a designer may wish to encapsulate or "pot" the product. There are a wide variety of potting compounds with varying dielectric properties. Since such compounds can considerably impact RF performance and the ability to rework or service the product, it is the responsibility of the designer to evaluate and qualify the impact and suitability of such materials.

Microstrip Details

A transmission line is a medium whereby RF energy is transferred from one place to another with minimal loss. This is a critical factor, especially in high-frequency products like Linx RF modules, because the trace leading to the module's antenna can effectively contribute to the length of the antenna, changing its resonant bandwidth. In order to minimize loss and detuning, some form of transmission line between the antenna and the module should be used unless the antenna can be placed very close ($<1/8$ in) to the module. One common form of transmission line is a coax cable and another is the microstrip. This term refers to a PCB trace running over a ground plane that is designed to serve as a transmission line between the module and the antenna. The width is based on the desired characteristic impedance of the line, the thickness of the PCB and the dielectric constant of the board material. For standard 0.062in thick FR-4 board material, the trace width would be 111 mils. The correct trace width can be calculated for other widths and materials using the information in Figure 64 and examples are provided in Figure 65. Software for calculating microstrip lines is also available on the Linx website.

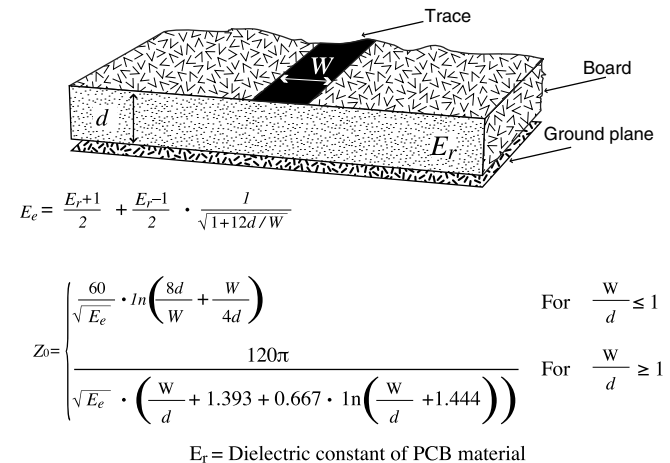

Figure 64: Microstrip Formulas

Example Microstrip Calculations			
Dielectric Constant	Width / Height Ratio (W / d)	Effective Dielectric Constant	Characteristic Impedance (Ω)
4.80	1.8	3.59	50.0
4.00	2.0	3.07	51.0
2.55	3.0	2.12	48.8

Figure 65: Example Microstrip Calculations

Production Guidelines

The module is housed in a hybrid SMD package that supports hand and automated assembly techniques. Since the modules contain discrete components internally, the assembly procedures are critical to ensuring the reliable function of the modules. The following procedures should be reviewed with and practiced by all assembly personnel.

Hand Assembly

Pads located on the bottom of the module are the primary mounting surface (Figure 66). Since these pads are inaccessible during mounting, castellations that run up the side of the module have been provided to facilitate solder wicking to the module's underside. This allows for very

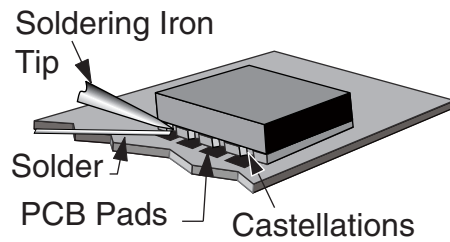

Figure 66: Soldering Technique

quick hand soldering for prototyping and small volume production. If the recommended pad guidelines have been followed, the pads will protrude slightly past the edge of the module. Use a fine soldering tip to heat the board pad and the castellation, then introduce solder to the pad at the module's edge. The solder will wick underneath the module, providing reliable attachment. Tack one module corner first and then work around the device, taking care not to exceed the times in Figure 67.

Warning: Pay attention to the absolute maximum solder times.

Absolute Maximum Solder Times

Hand Solder Temperature: +427°C for 10 seconds for lead-free alloys

Reflow Oven: +255°C max (see Figure 71)

Figure 67: Absolute Maximum Solder Times

Automated Assembly

For high-volume assembly, the modules are generally auto-placed. The modules have been designed to maintain compatibility with reflow processing techniques; however, due to their hybrid nature, certain aspects of the assembly process are far more critical than for other component types. Following are brief discussions of the three primary areas where caution must be observed.

Reflow Temperature Profile

The single most critical stage in the automated assembly process is the reflow stage. The reflow profile in Figure 68 should not be exceeded because excessive temperatures or transport times during reflow will irreparably damage the modules. Assembly personnel need to pay careful attention to the oven's profile to ensure that it meets the requirements necessary to successfully reflow all components while still remaining within the limits mandated by the modules. The figure below shows the recommended reflow oven profile for the modules.

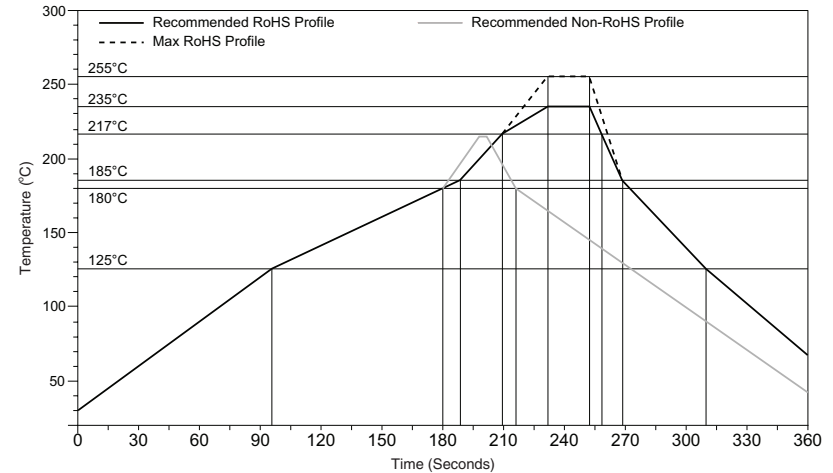

Figure 68: Maximum Reflow Temperature Profile

Shock During Reflow Transport

Since some internal module components may reflow along with the components placed on the board being assembled, it is imperative that the modules not be subjected to shock or vibration during the time solder is liquid. Should a shock be applied, some internal components could be lifted from their pads, causing the module to not function properly.

Washability

The modules are wash-resistant, but are not hermetically sealed. Linx recommends wash-free manufacturing; however, the modules can be subjected to a wash cycle provided that a drying time is allowed prior to applying electrical power to the modules. The drying time should be sufficient to allow any moisture that may have migrated into the module to evaporate, thus eliminating the potential for shorting damage during power-up or testing. If the wash contains contaminants, the performance may be adversely affected, even after drying.

General Antenna Rules

The following general rules should help in maximizing antenna performance.

1. Proximity to objects such as a user's hand, body or metal objects will cause an antenna to detune. For this reason, the antenna shaft and tip should be positioned as far away from such objects as possible.
2. Optimum performance is obtained from a $\frac{1}{4}$ - or $\frac{1}{2}$ -wave straight whip mounted at a right angle to the ground plane (Figure 69). In many cases, this isn't desirable for practical or ergonomic reasons, thus, an alternative antenna style such as a helical, loop or patch may be utilized and the corresponding sacrifice in performance accepted.

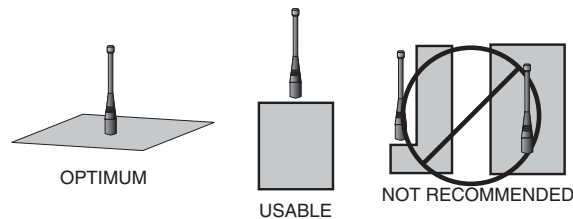

Figure 69: Ground Plane Orientation

3. If an internal antenna is to be used, keep it away from other metal components, particularly large items like transformers, batteries, PCB tracks and ground planes. In many cases, the space around the antenna is as important as the antenna itself. Objects in close proximity to the antenna can cause direct detuning, while those farther away will alter the antenna's symmetry.
4. In many antenna designs, particularly $\frac{1}{4}$ -wave whips, the ground plane acts as a counterpoise, forming, in essence, a $\frac{1}{2}$ -wave dipole (Figure 70). For this reason, adequate ground plane area is essential. The ground plane can be a metal case or ground-fill areas on a circuit board. Ideally, it should have a surface area less than or equal to the overall length of the $\frac{1}{4}$ -wave radiating element. This is often not practical due to size and configuration constraints. In these instances, a designer must make the best use of the area available to create as much ground

VERTICAL $\lambda/4$ GROUNDED ANTENNA (MARCONI)

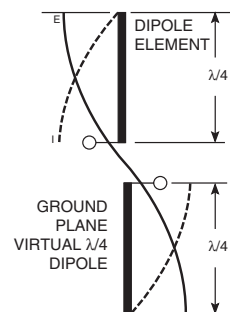

Figure 70: Dipole Antenna

plane as possible in proximity to the base of the antenna. In cases where the antenna is remotely located or the antenna is not in close proximity to a circuit board, ground plane or grounded metal case, a metal plate may be used to maximize the antenna's performance.

5. Remove the antenna as far as possible from potential interference sources. Any frequency of sufficient amplitude to enter the receiver's front end will reduce system range and can even prevent reception entirely. Switching power supplies, oscillators or even relays can also be significant sources of potential interference. The single best weapon against such problems is attention to placement and layout. Filter the module's power supply with a high-frequency bypass capacitor. Place adequate ground plane under potential sources of noise to shunt noise to ground and prevent it from coupling to the RF stage. Shield noisy board areas whenever practical.
6. In some applications, it is advantageous to place the module and antenna away from the main equipment (Figure 71). This can avoid interference problems and allows the antenna to be oriented for optimum performance. Always use 50Ω coax, like RG-174, for the remote feed.

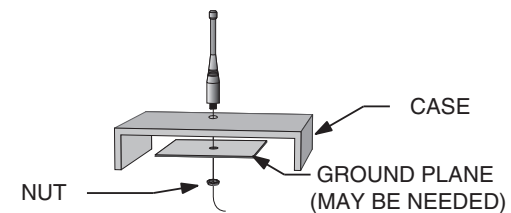

Figure 71: Remote Ground Plane

Common Antenna Styles

There are hundreds of antenna styles and variations that can be employed with Linx RF modules. Following is a brief discussion of the styles most commonly utilized. Additional antenna information can be found in Linx Application Notes AN-00100, AN-00140, AN-00500 and AN-00501. Linx antennas and connectors offer outstanding performance at a low price.

Whip Style

A whip style antenna (Figure 72) provides outstanding overall performance and stability. A low-cost whip can be easily fabricated from a wire or rod, but most designers opt for the consistent performance and cosmetic appeal of a professionally-made model. To meet this need, Linx offers a wide variety of straight and reduced height whip style antennas in permanent and connectorized mounting styles.



Figure 72: Whip Style Antennas

The wavelength of the operational frequency determines an antenna's overall length. Since a full wavelength is often quite long, a partial 1/2- or 1/4-wave antenna is normally employed. Its size and natural radiation resistance make it well matched to Linx modules. The proper length for a straight 1/4-wave can be easily determined using the formula in Figure 73. It is also possible to reduce the overall height of the antenna by using a helical winding. This reduces the antenna's bandwidth but is a great way to minimize the antenna's physical size for compact applications. This also means that the physical appearance is not always an indicator of the antenna's frequency.

$$L = \frac{234}{F_{\text{MHz}}}$$

Figure 73:
L = length in feet of quarter-wave length
F = operating frequency in megahertz

Specialty Styles

Linx offers a wide variety of specialized antenna styles (Figure 74). Many of these styles utilize helical elements to reduce the overall antenna size while maintaining reasonable performance. A helical antenna's bandwidth is often quite narrow and the antenna can detune in proximity to other objects, so care must be exercised in layout and placement.



Figure 74: Specialty Style Antennas

Loop Style

A loop or trace style antenna is normally printed directly on a product's PCB (Figure 75). This makes it the most cost-effective of antenna styles. The element can be made self-resonant or externally resonated with discrete components, but its actual layout is usually product specific. Despite the cost advantages, loop style antennas are generally inefficient and useful only for short range applications. They are also very sensitive to changes in layout and PCB dielectric, which can cause consistency issues during production. In addition, printed styles are difficult to engineer, requiring the use of expensive equipment including a network analyzer. An improperly designed loop will have a high VSWR at the desired frequency which can cause instability in the RF stage.



Figure 75: Loop or Trace Antenna

Linx offers low-cost planar (Figure 76) and chip antennas that mount directly to a product's PCB. These tiny antennas do not require testing and provide excellent performance despite their small size. They offer a preferable alternative to the often problematic "printed" antenna.



Figure 76: SP Series "Splatch" and uSP "MicroSplatch" Antennas

Regulatory Considerations

Note: Linx RF modules are designed as component devices that require external components to function. The purchaser understands that additional approvals may be required prior to the sale or operation of the device, and agrees to utilize the component in keeping with all laws governing its use in the country of operation.

When working with RF, a clear distinction must be made between what is technically possible and what is legally acceptable in the country where operation is intended. Many manufacturers have avoided incorporating RF into their products as a result of uncertainty and even fear of the approval and certification process. Here at Linx, our desire is not only to expedite the design process, but also to assist you in achieving a clear idea of what is involved in obtaining the necessary approvals to legally market a completed product.

For information about regulatory approval, read AN-00142 on the Linx website or call Linx. Linx designs products with worldwide regulatory approval in mind.

In the United States, the approval process is actually quite straightforward. The regulations governing RF devices and the enforcement of them are the responsibility of the Federal Communications Commission (FCC). The regulations are contained in Title 47 of the United States Code of Federal Regulations (CFR). Title 47 is made up of numerous volumes; however, all regulations applicable to this module are contained in Volume 0-19. It is strongly recommended that a copy be obtained from the FCC's website, the Government Printing Office in Washington or from your local government bookstore. Excerpts of applicable sections are included with Linx evaluation kits or may be obtained from the Linx Technologies website, www.linxtechnologies.com. In brief, these rules require that any device that intentionally radiates RF energy be approved, that is, tested for compliance and issued a unique identification number. This is a relatively painless process. Final compliance testing is performed by one of the many independent testing laboratories across the country. Many labs can also provide other certifications that the product may require at the same time, such as UL, CLASS A / B, etc. Once the completed product has passed, an ID number is issued that is to be clearly placed on each product manufactured.

Questions regarding interpretations of the Part 2 and Part 15 rules or the measurement procedures used to test intentional radiators such as Linx RF modules for compliance with the technical standards of Part 15 should be addressed to:

Federal Communications Commission
Equipment Authorization Division
Customer Service Branch, MS 1300F2
7435 Oakland Mills Road
Columbia, MD, US 21046
Phone: + 1 301 725 585 | Fax: + 1 301 344 2050
Email: labinfo@fcc.gov

ETSI Secretaria
650, Route des Lucioles
06921 Sophia-Antipolis Cedex
FRANCE
Phone: +33 (0)4 92 94 42 00
Fax: +33 (0)4 93 65 47 16

International approvals are slightly more complex, although Linx modules are designed to allow all international standards to be met. If the end product is to be exported to other countries, contact Linx to determine the specific suitability of the module to the application.

All Linx modules are designed with the approval process in mind and thus much of the frustration that is typically experienced with a discrete design is eliminated. Approval is still dependent on many factors, such as the choice of antennas, correct use of the frequency selected and physical packaging. While some extra cost and design effort are required to address these issues, the additional usefulness and profitability added to a product by RF makes the effort more than worthwhile.



Linx Technologies
159 Ort Lane
Merlin, OR, US 97532

Phone: +1 541 471 6256
Fax: +1 541 471 6251

www.linxtechnologies.com

Disclaimer

Linx Technologies is continually striving to improve the quality and function of its products. For this reason, we reserve the right to make changes to our products without notice. The information contained in this Data Guide is believed to be accurate as of the time of publication. Specifications are based on representative lot samples. Values may vary from lot-to-lot and are not guaranteed. "Typical" parameters can and do vary over lots and application. Linx Technologies makes no guarantee, warranty, or representation regarding the suitability of any product for use in any specific application. It is the customer's responsibility to verify the suitability of the part for the intended application. **NO LINX PRODUCT IS INTENDED FOR USE IN ANY APPLICATION WHERE THE SAFETY OF LIFE OR PROPERTY IS AT RISK.**

Linx Technologies **DISCLAIMS ALL WARRANTIES OF MERCHANTABILITY AND FITNESS FOR A PARTICULAR PURPOSE. IN NO EVENT SHALL LINX TECHNOLOGIES BE LIABLE FOR ANY OF CUSTOMER'S INCIDENTAL OR CONSEQUENTIAL DAMAGES ARISING IN ANY WAY FROM ANY DEFECTIVE OR NON-CONFORMING PRODUCTS OR FOR ANY OTHER BREACH OF CONTRACT BY LINX TECHNOLOGIES.** The limitations on Linx Technologies' liability are applicable to any and all claims or theories of recovery asserted by Customer, including, without limitation, breach of contract, breach of warranty, strict liability, or negligence. Customer assumes all liability (including, without limitation, liability for injury to person or property, economic loss, or business interruption) for all claims, including claims from third parties, arising from the use of the Products. The Customer will indemnify, defend, protect, and hold harmless Linx Technologies and its officers, employees, subsidiaries, affiliates, distributors, and representatives from and against all claims, damages, actions, suits, proceedings, demands, assessments, adjustments, costs, and expenses incurred by Linx Technologies as a result of or arising from any Products sold by Linx Technologies to Customer. Under no conditions will Linx Technologies be responsible for losses arising from the use or failure of the device in any application, other than the repair, replacement, or refund limited to the original product purchase price. Devices described in this publication may contain proprietary, patented, or copyrighted techniques, components, or materials. Under no circumstances shall any user be conveyed any license or right to the use or ownership of such items.

©2015 Linx Technologies. All rights reserved.

The stylized Linx logo, Wireless Made Simple, WISE, CipherLinx and the stylized CL logo are trademarks of Linx Technologies.