



Please contact us about TUV certified products.



**High capacity up to 10A  
PCB terminal type SSR**

**AQ1 RELAYS**

### FEATURES



**1. 10A high-capacity realized for PC board terminal (when using heat sink) SSR for compact PC boards with 10 A capacity that is two times greater than our previous model. It is suitable for long-life, highly frequent control.**

**2. VDE (EN60950-1) reinforced insulation compliant**  
Fully satisfies demand for safety by guaranteeing compliance with EN60950-1 safety standard and featuring 3,000 V reinforced insulation (AQ3A2-ZT4/32VDC, AQ3A2-J-ZT4/32VDC and AQ10A2-ZT4/32VDC).

**3. Superior anti-vibration and anti-shock characteristics**  
The body is molded as a single unit with flame resistant resin which makes it highly resistant against vibration and shock, and gives it superior protection from environment. The body can also be washed.

**4. Vertical types with SIL terminal arrangement and flat types are available.**  
1) The vertical type is available in thicknesses of 10 mm (2 A and 3 A types) and 12 mm (10 A type). Terminal arrangement is SIL in integral multiples of 2.54 mm (0.1 inch).  
2) The height of the flat type is 12 mm. The terminal arrangement is DIL in integral multiples of 2.54 mm.

**5. Reduced noise generation**  
The load will operate at close to zero voltage even when the input signal is applied during a cycle. Also, even if an input signal is cancelled during a cycle, the load is cut off at close to zero current. For this reason, hardly any noise is produced and radio frequency interference (RFI) and electromagnetic interference (EMI) are kept to a minimum.

**6. Built-in snubber circuit prevents malfunction.**

### TYPICAL APPLICATIONS

- Printing machines
- Packing machines
- Traffic signal control
- Automatic ticket punchers
- Terminal equipment of data processing
- Computer peripherals
- NC machines

RoHS compliant

### ORDERING INFORMATION

AQ  -  -  -

Load current  
1 A, 2 A, 3 A, 10 A

Load voltage  
2: 75 to 250 V AC  
D1: 3 to 60 V DC  
D2: 10 to 200 V DC

Shape  
Nil: Vertical type  
J: Flat type

Nil: DC output  
ZT: Zero-cross AC output (Phototriac coupler)

Input voltage  
3/28 V DC: 3 to 28 V DC  
4/32 V DC: 4 to 32 V DC

\* Random types are available by custom order.

## TYPES

### 1. AQ1 Solid State Relays

Load	Isolation	Zero-cross function	Type	Load current	Load voltage	Input voltage	Part No.
AC	Phototriac coupler	Zero-cross*1	Vertical	3 A	75 to 250 V AC	4 to 32 V DC	AQ3A2-ZT4/32VDC
			Flat	3 A	75 to 250 V AC	4 to 32 V DC	AQ3A2-J-ZT4/32VDC
			Vertical	10 A*2	75 to 250 V AC	4 to 32 V DC	AQ10A2-ZT4/32VDC
DC	Phototransistor	-	Vertical	1 A	10 to 200 V DC	3 to 28 V DC	AQ1AD2-3/28VDC
			Vertical	2 A	3 to 60 V DC	3 to 28 V DC	AQ2AD1-3/28VDC

Standard packing: Carton 20 pcs., Case 200 pcs.

Notes: \*1. Random type also available. Please inquire.

\*2. 5 A without heat sink

### 2. Heat sink for AQ1 solid state relay

Product name	Part No.
Heat sink for AQ10A2-ZT4/32VDC	AQ-HS-5A

Standard packing: Carton 20 pcs., Case 200 pcs.

## SPECIFICATIONS

### 1. Rating (Ambient temperature: 20°C 68°F, Ripple factor: less than 1%)

Item	Type	AC output type		DC output type		Remarks
		Zero-cross		1 A type	2 A type	
		3 A type	10 A type			
Input side	Input voltage	4 to 32 V DC		3 to 28 V DC		*1
	Input impedance	—		Approx. 1.6 kΩ		
	Input current, max.	20 mA		—		
	Drop-out voltage, min.	1.0 V		0.8 V		
Load side	Max. load current*2	3 A	10 A*5	1 A	2 A	Refer to REFERENCE DATA "1. Load current vs. ambient temperature characteristics".
	Load voltage	75 to 250 V AC		10 to 200 V DC	3 to 60 V DC	
	Non-repetitive surge current*3	100 A		5 A		AC: In one cycle at 60 Hz, DC: 1s
	Max. "OFF-state" leakage current	5 mA		1 mA		AC: at 200 V, 60Hz DC: When maximum load voltage is applied.
	Max. "ON-state" voltage drop	1.6 V		1.6 V	2.3 V	At Max. carrying current
	Min. load current*4	50 mA		5 mA		

Notes: \*1. Refer to REFERENCE DATA "3. Input current vs. input voltage characteristics".

\*2. Refer to REFERENCE DATA "1. Load current vs. ambient temperature".

\*3. Refer to REFERENCE DATA "2. Non-repetitive surge current vs. carrying time".

\*4. When load current is below the rating, refer to "Cautions for Use".

\*5. When heat sink (AQ-HS-5A) is installed. The max. load current is 5 A when heat sink is not installed.

### 2. Characteristics (Ambient temperature: 20°C 68°F, Ripple factor: less than 1%)

Item	Type	AC output		DC output	Remarks
		Zero-cross			
		3 A type	10 A type		
Operate time, Max.		1/2 cycle of voltage sine wave + 1 ms		0.5 ms	
Release time, Max.		1/2 cycle of voltage sine wave + 1 ms		2 ms	
Insulation resistance, Min.		100 M Ω for input, output and case		100 M Ω for input, output	at 500 V DC
Breakdown voltage		4,000 Vrms between input and output 2,500 Vrms between input, output and case		3,000 Vrms between input-output	For 1 minute
Vibration resistance	Destructive	10 to 55 Hz at double amplitude of 2 mm		10 to 55 Hz at double amplitude of 2 mm	1 hour for X, Y, Z axis
	Functional	10 to 55 Hz at double amplitude of 2 mm		10 to 55 Hz at double amplitude of 2 mm	10 minutes for X, Y, Z axis
Shock resistance	Destructive	Min. 980 m/s <sup>2</sup> {100 G}		Min. 980 m/s <sup>2</sup> {100 G}	5 times each for X, Y, Z axis
	Functional	Min. 980 m/s <sup>2</sup> {100 G}		Min. 980 m/s <sup>2</sup> {100 G}	4 times each for X, Y, Z axis
Ambient temperature		-30°C to +80°C -22°F to +176°F			
Storage temperature		-30°C to +100°C -22°F to +212°F			
Operational method		Zero-cross (Turn-ON and Turn-OFF)		—	

## REFERENCE DATA

1.-(1) Load current vs. ambient temperature  
(AC output, 3 A type) Part No.: AQ3A2-ZT4/32VDC  
and AQ3A2-J-ZT4/32VDC  
Allowable ambient temperature:  
-30°C to +80°C -22°F to +176°F

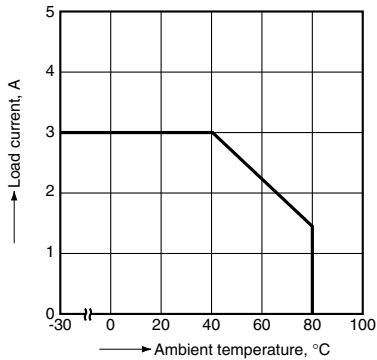

1.-(2) Load current vs. ambient temperature  
(AC output, 10 A type) Part No.: AQ10A2-ZT4/32VDC  
(A) When not using a heat sink  
(B) When using a standard heat sink AQ-HS-5A  
(When attached to a heat sink, use a heat conductive  
compound (Ex. Toshiba silicone YG6111 or TSK5303)  
of similar coating to improve cooling.)

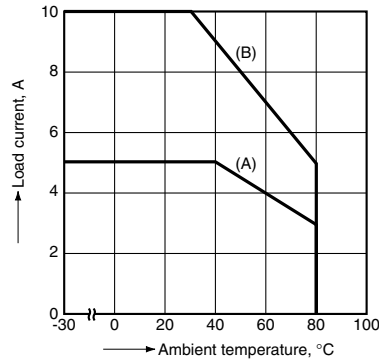

1.-(3) Load current vs. ambient temperature  
(DC output, 1 A and 2 A types) Part No.: AQ1AD2-3/  
28VDC and AQ2AD1-3/28VDC  
Allowable ambient temperature:  
-30°C to +80°C -22°F to +176°F

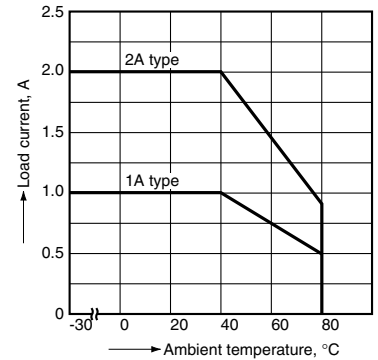

2.-(1) Non-repetitive surge current vs.  
carrying time  
(AC output, 3 A and 10 A types)  
Part No.: AQ3A2-ZT4/32VDC, AQ3A2-J-ZT4/32VDC  
and AQ10A2-ZT4/32VDC

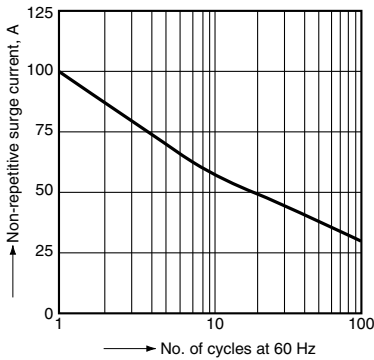

2.-(2) Non-repetitive surge current vs.  
carrying time  
(DC output) Part No.: AQ1AD2-3/28VDC and  
AQ2AD1-3/28VDC

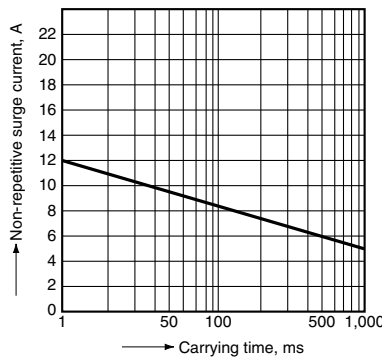

3.-(1) Input current vs. input voltage  
characteristics  
(AC output, 3 A and 10 A types)  
Part No.: AQ3A2-ZT4/32VDC, AQ3A2-J-ZT4/32VDC  
and AQ10A2-ZT4/32VDC

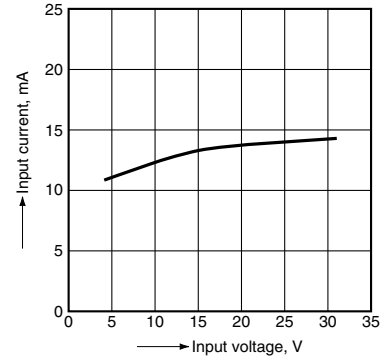

3.-(2) Input current vs. input voltage  
characteristics  
(DC output)  
Part No.: AQ1AD2-3/28VDC and AQ2AD1-3/28VDC

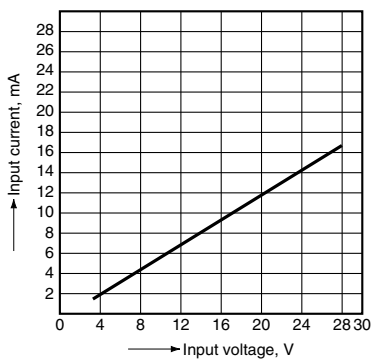

4.-(1) Load current vs. ambient temperature  
characteristics for adjacent mounting  
(AC output, 3A vertical type)  
Part No.: AQ3A2-ZT4/32VDC

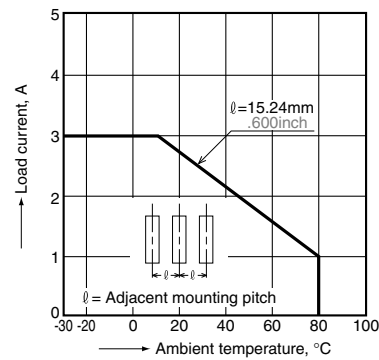

4.-(2) Load current vs. ambient temperature  
characteristics for adjacent mounting  
(AC output, 10A type)  
Part No.: AQ10A2-ZT4/32VDC (without heat sink)

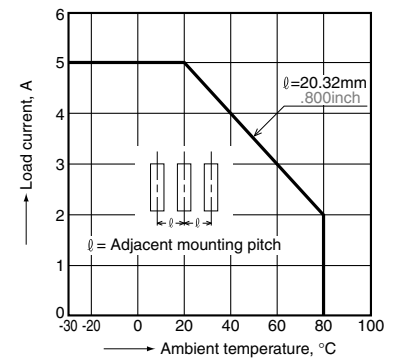

**DIMENSIONS** (mm inch)

The CAD data of the products with a **CAD Data** mark can be downloaded from: <http://industrial.panasonic.com/ac/e/>

**1. AC output, 3A type (Vertical)**

**CAD Data**

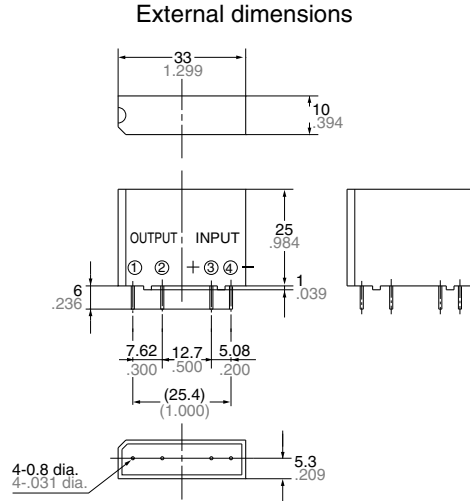

**Mounting hole location (Copper-side view)**

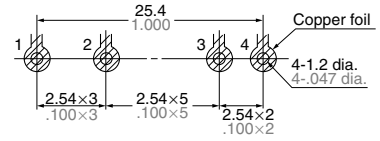

**Schematic**

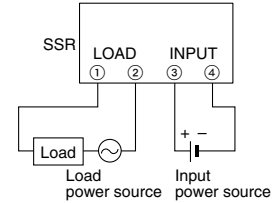

General tolerance:  $\pm 0.5 \pm .020$

Tolerance:  $\pm 0.1 \pm .004$

**2. AC output, 3A type (Flat)**

**CAD Data**

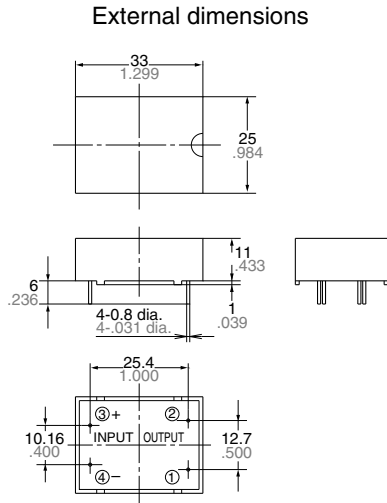

**Mounting hole location (Copper-side view)**

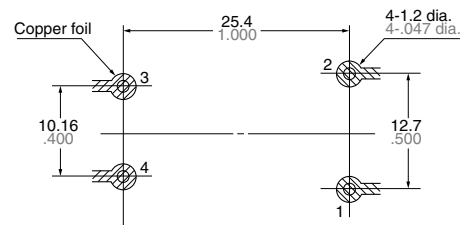

**Schematic**

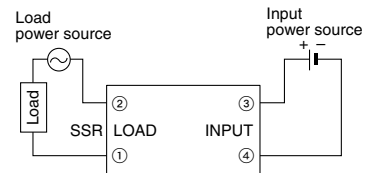

General tolerance:  $\pm 0.5 \pm .020$

Tolerance:  $\pm 0.1 \pm .004$

**3. AC output, 10A type (Vertical)**

**CAD Data**

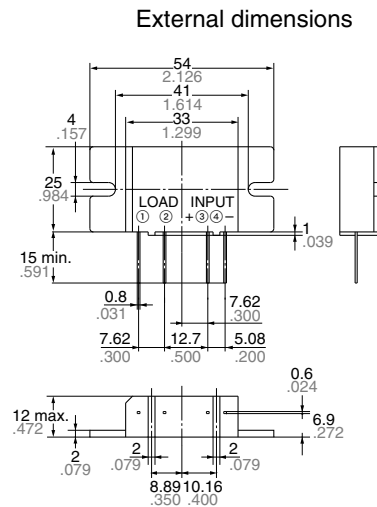
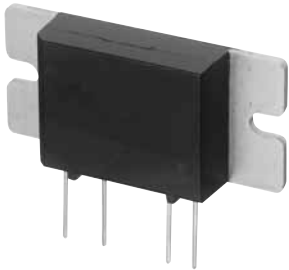

**Mounting hole location (Copper-side view)**

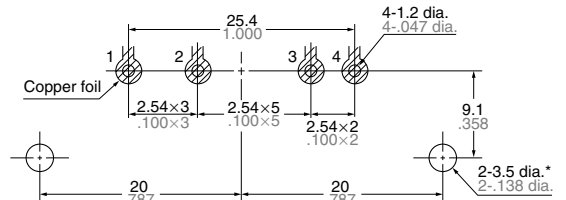

\* There 2 holes are not necessary when not using heat sink (AQ-HS-5A)

**Schematic**

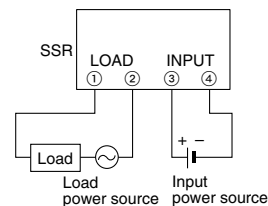

General tolerance:  $\pm 0.5 \pm .020$

Tolerance:  $\pm 0.1 \pm .004$

4. Heat sink (for AQ10A2-ZT4/32VDC)

CAD Data

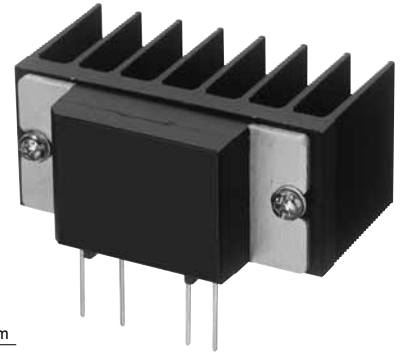
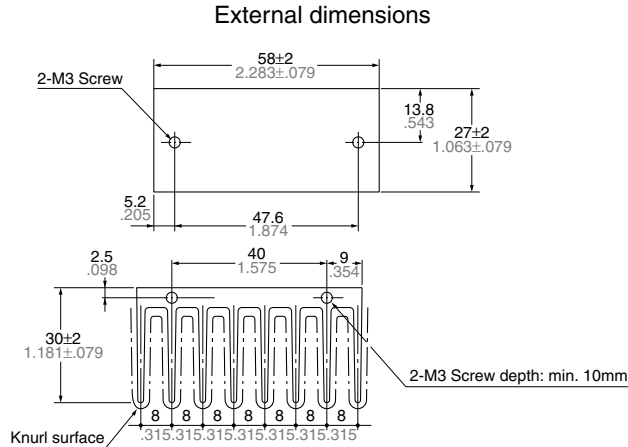

Heat sink attached to AQ1 relay

General tolerance:  $\pm 0.5 \pm 0.20$

Note: When using heat sink, please refer to "Thermal Design"

5. DC output, 1A and 2A types (Vertical)

CAD Data

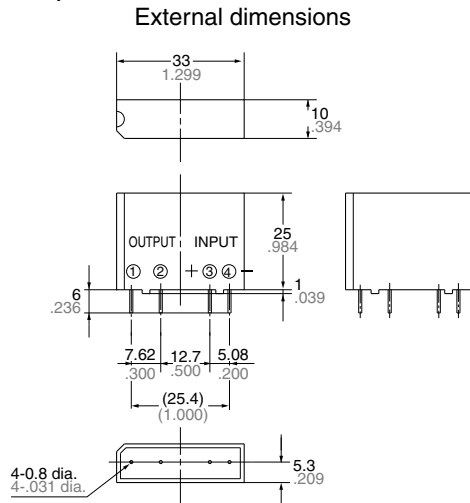

General tolerance:  $\pm 0.5 \pm 0.20$

Mounting hole location (Copper-side view)

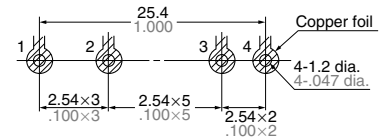

Schematic

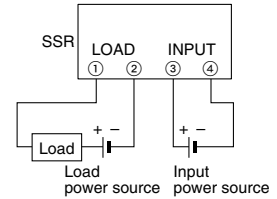

Tolerance:  $\pm 0.1 \pm 0.04$

NOTE

1. When using bent output terminals

To avoid applying mechanical stress on the main unit and molded section of the solid state relay, radio pliers should be used to grasp the terminals between the point of bending and the molded case when making the bends.

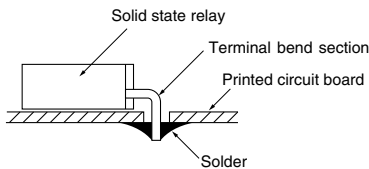

2. Thermal design

When a heat sink is mounted on the 10 A type

The heat sink (AQ-HS-5A) or a radiator which can make good contact should be used.

If a heat sink is used in which the contact condition is bad, a heat conducting compound should be used to improve the heat radiation. (Ex. Momentive Performance Materials Inc. YG6111 or TSK5303) The compound should be applied between the heat sink and the AQ1.

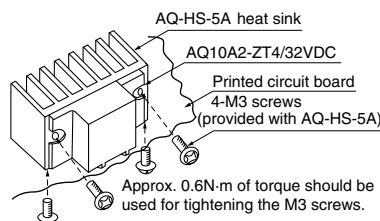

## Recommended Temperature Controllers

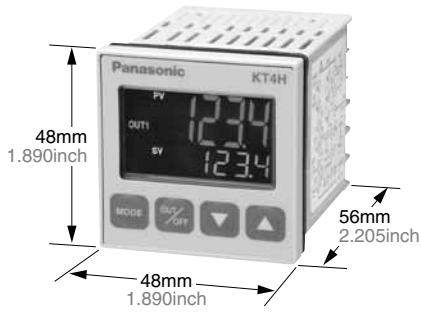

### <KT4H Temperature Controller>

Our temperature controller is recommended for use with our Solid State Relays.

#### Features

- Space saving requiring only a depth of 65 mm
- Data collection possible through a PLC using RS485 communication
- Tool port is standard for easy data setting
- Inverted LCD + backlight for good legibility with large characters
- Excellent operability and rich optional control functions

#### Substitute part numbers

Power supply	Control output	Part No.
100 to 240 V AC	Non-contact voltage output	AKT4H112100

\* For detailed product information about temperature controllers, please refer to our website:  
<http://industrial.panasonic.com/ac/e/>