

■ Product Summary

Type	Bipolar IC with Photo Detectors
Application	OEIC for BD Front Monitor
Structure	Silicon Monolithic Bipolar IC

■ Absolute Maximum Ratings

Item	Symbol	Ratings	Unit	Remarks
Operating supply voltage	V _{CC}	6	V	
Power dissipation	P _D	250	mW	
Operating ambient temperature	T _{opr}	-10 ~ +75	°C	
Storage temperature	T _{stg}	-40 ~ +85	°C	

■ Operating Conditions

Item	Symbol	Condition	Min.	Typ.	Max.	Unit
Operating supply voltage	V _{CC}		4.3	5.0	5.5	V

■ Electrical-Optical Characteristics

(T_a=25 °C±3 °C, V_{CC}=5.0 V, R_L=10 kΩ, C_L=20 pF, V_R=BFh)

Item	Symbol	Mode	Condition	Min.	Typ.	Max.	Unit
Reference voltage	V _{ref}		T _a =25 °C, V _{CC} =5 V	1.9	2.0	2.1	V
Supply current	I _{CC}		No Signal Condition	—	14	24	mA
Supply current (Sleep)	I _{CC(SL)}	Sleep mode	No Signal Condition	—	850	—	μA
High level input voltage	V _{IH}		(Serial interface)	2.4	—	V _{CC}	V
Low level input voltage	V _{IL}		(Serial interface)	0	—	0.7	V
Output sensitivity1 (Note1)	Gain1	High mode	λ =405 nm (BD)	-20 %	4.65	+20 %	mV/μW
		Middle mode	λ =405 nm (BD)	-20 %	2.39	+20 %	mV/μW
		Low mode	λ =405 nm (BD)	-20 %	1.24	+20 %	mV/μW
Output sensitivity2 (Note1)	Gain2	High mode	λ =650 nm(DVD)	-20 %	7.83	+20 %	mV/μW
		Middle mode	λ =650 nm(DVD)	-20 %	4.04	+20 %	mV/μW
		Low mode	λ =650 nm(DVD)	-20 %	2.08	+20 %	mV/μW
Output sensitivity3 (Note1)	Gain3	High mode	λ =780 nm(CD)	-20 %	7.0	+20 %	mV/μW
		Middle mode	λ =780 nm(CD)	-20 %	3.61	+20 %	mV/μW
		Low mode	λ =780 nm(CD)	-20 %	1.86	+20 %	mV/μW

(Note1) The offset voltage is not contained.

■ Electrical-Optical Characteristics

(Ta=25 °C±3 °C, Vcc=5.0 V, RL=10 kΩ, CL=20 pF, VR=BFh)

Item	Symbol	Mode	Condition	Min.	Typ.	Max.	Unit
Drift of output offset voltage	dV _{OFF}	High mode	No Signal Condition, VoP-VoN	-30	0	+30	mV
		Middle mode	No Signal Condition, VoP-VoN	-30	0	+30	mV
		Low mode	No Signal Condition, VoP-VoN	-30	0	+30	mV
Maximum output voltage (Note2)	V _{OM}	High mode	No Signal Condition, VoP-VoN	2.0	2.2	—	V
		Middle mode	No Signal Condition, VoP-VoN	2.0	2.2	—	V
		Low mode	No Signal Condition, VoP-VoN	2.0	2.2	—	V
Drift of output offset voltage by temperature (Note3)	dV _{OFF} /Ta	High mode	No Signal Condition, Ta=-10 °C~75 °C	-100	0	+100	μV/°C
		Middle mode	No Signal Condition, Ta=-10 °C~75 °C	-100	0	+100	μV/°C
		Low mode	No Signal Condition, Ta=-10 °C~75 °C	-100	0	+100	μV/°C
Cutoff frequency (Note3)	f _c	High mode	f-3dB (Base 1 MHz)	70	100	—	MHz
		Middle mode	f-3dB (Base 1 MHz)	70	100	—	MHz
		Low mode	f-3dB (Base 1 MHz)	70	100	—	MHz
Settling time (Note3)	t _{sel}	High mode		—	9	12	ns
		Middle mode		—	9	12	ns
		Low mode		—	9	12	ns
Range of Gain width (2nd Amp)	V _{odH}		Gain : FFh~BFh~00h	(0) FFh	(6) BFh	(13.8) 00h	dB

(Note2) Saturation value

(Note3) Design guaranteeing item.

■ Circuit Function Block Diagram

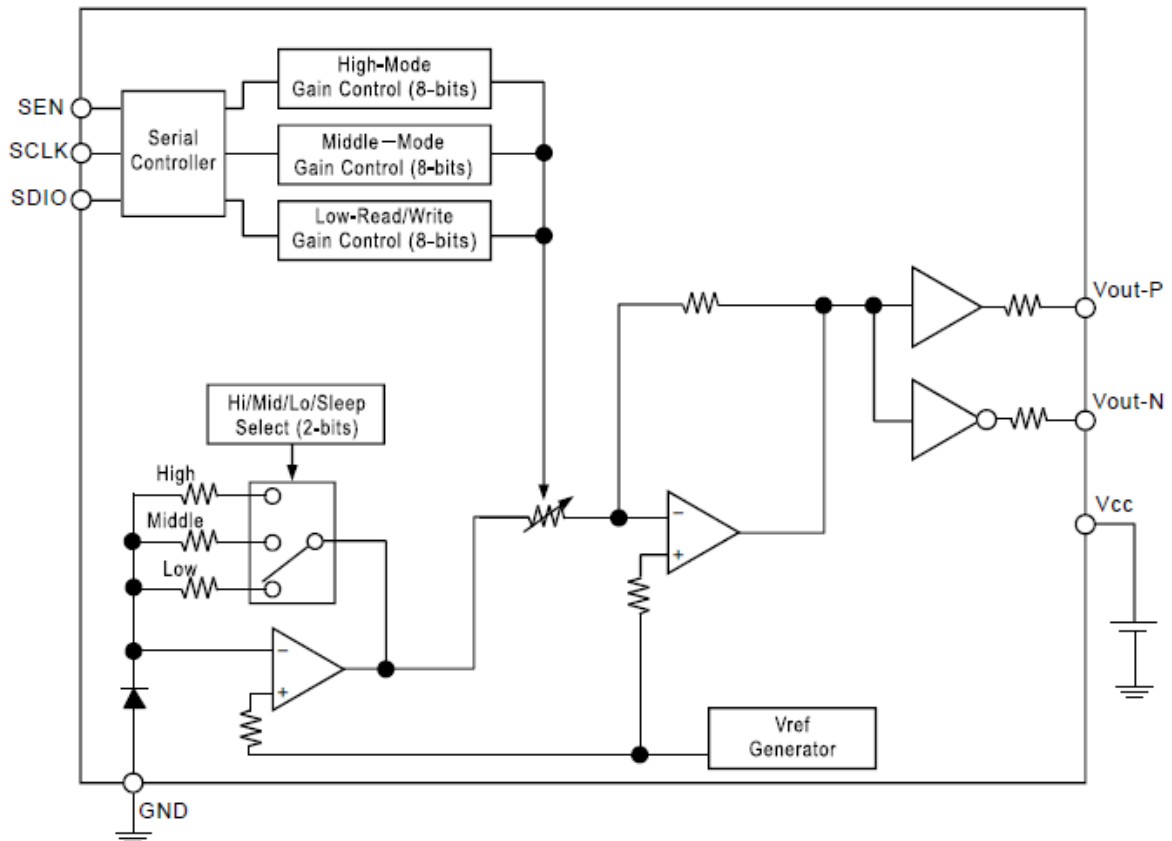

■ Explanation for Terminal Function

No.	Terminal Name	No.	Terminal Name
①	GND	⑤	NC(GND)
②	SEN	⑥	Vout-N
③	SDIO	⑦	Vout-P
④	SCLK	⑧	Vcc

■ Technical Data

1. Serial interface timing specification

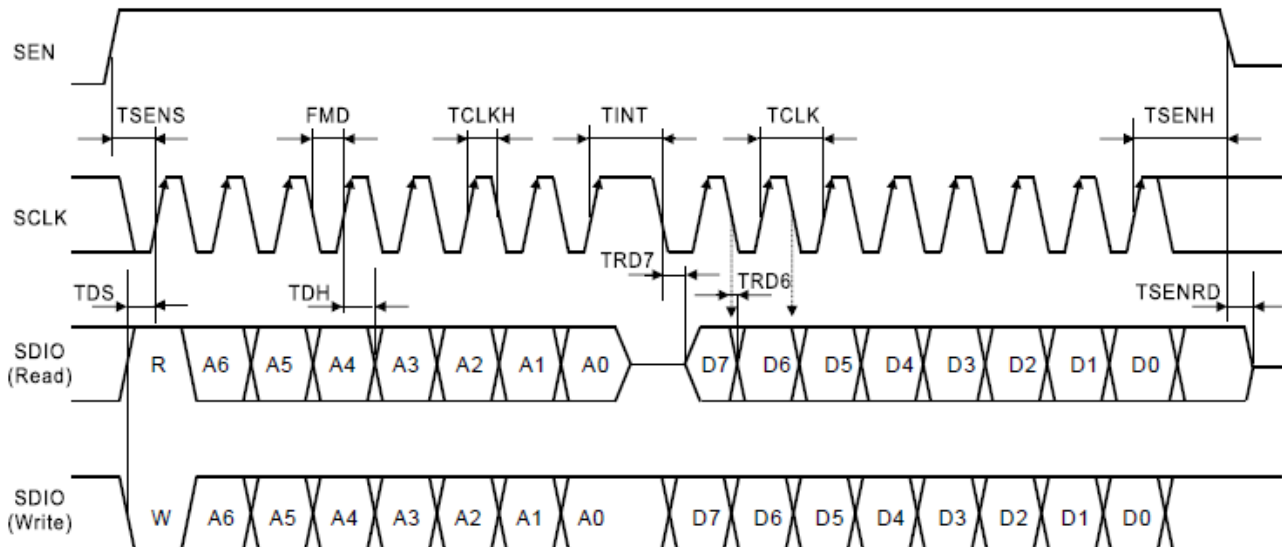

Figure Serial interface protocol (Register write & read)

The program register that sets operation in FMD is composed of the 7-bit address and the 8-bit data, the address and data are input to the serial from the SDIO terminal.

It is input from the SDIO terminal in order of RWB (=“L”), the address, and data at “Write” when SEN=“H” period. Please input the address and data with MSB first.

The address and the data input from the SDIO terminal are taken into the register synchronizing with rising edge of SCLK.

It is input from the SDIO terminal in order of RWB (=“H”), the address, and data at “Read” when SEN=“H” period. Please input the address with MSB first.

The input address is loaded into the inside at the rising edge of SCLK. Then the data that corresponds to the set address is output from the SDIO terminal.

Output data outputs D7 synchronizing with the falling edge of SCLK that took A0, then it's output synchronizing with the falling edge of SCLK(D6~D7).

Item	Symbol	Reference value			Unit
		Min.	Typ.	Max.	
SCLK cycle	TCLK	1 000	—	—	ns
SDIO setup time	TDS	150	—	—	ns
SDIO hold time	TDH	150	—	—	ns
SCLK,SEN setup time	TSENS	350	—	—	ns
SEN hold time (Write mode)	TSENH	750	—	—	ns
SCLK High time	TCLKH	400	—	—	ns
SCLK Low time	TCLKL	400	—	—	ns
Write - Read interval	TINT	400	—	—	ns
Read(D7) output time	TRD7	—	—	20	ns
Read(D6) output time	TRD6	—	—	15	ns
SDIO Hi-Z output time	TSENRD	—	—	10	ns
Output voltage (Read mode Lo)	VRD(Lo)	-0.3	0	V _{cc} +15 %	V
Output voltage (Read mode Hi)	VRD(Hi)	V _{cc} +85 %	V _{cc}	V _{cc} +0.3 V	V

2. Register Map

2.1 Table

Address A6 : A0	Application	D7	D6	D5	D4	D3	D2	D1	D0	Access	Gain setup Remarks	
1110000 (70 hex)	CONTROL	Spare	High/Middle/Lo/Sleep	Spare							R/W	Register for various mode setting
1110001 (71 hex)	High-Gain	High-Gain 256 level (8 bit)								R/W	Register for High-Gain setting	
1110010 (72 hex)	Middle-Gain	Middle-Gain 256 level (8 bit)								R/W	Register for Middle-Gain setting	
1110011 (73 hex)	Low-Gain	Low-Gain 256 level (8 bit)								R/W	Register for Low-Gain setting	

(1) Initial value

All bit is "0" in the default value after the power supply is turned on.

(2) Register reset

An initial value is only decided when the power supply is turned on, and Register reset isn't especially installed.

The former state is held at the sleep.

(3) An address other than 70, 71, 72, 73hex

In case of access to unused address.

At the showing of "Write" : The mode is not stored in the register.

At the showing of "Read" : No output data. (Hi-Z)

2.2 Detailed explanation

(1)Address 70 hex

A6	A5	A4	A3	A2	A1	A0	D7	D6	D5	D4	D3	D2	D1	D0
1	1	1	0	0	0	0	Hi/Mid/Lo/Sleep							

D6	D5	Mode
0	0	Sleep Mode
0	1	High Mode
1	0	Middle Mode
1	1	Low Mode

A6	A5	A4	A3	A2	A1	A0	D7	D6	D5	D4	D3	D2	D1	D0
1	1	1	0	0	0	0	Spare			Spare				

Spare data bit

(2)Address 71 hex

A6	A5	A4	A3	A2	A1	A0	D7	D6	D5	D4	D3	D2	D1	D0
1	1	1	0	0	0	1	High - Mode							

The gain setting of the High-mode is done.

(3)Address 72 hex

A6	A5	A4	A3	A2	A1	A0		D7	D6	D5	D4	D3	D2	D1	D0
1	1	1	0	0	1	0		Middle - Mode							

The gain setting of the Middle-mode is done.

(4)Address 73 hex

A6	A5	A4	A3	A2	A1	A0		D7	D6	D5	D4	D3	D2	D1	D0
1	1	1	0	0	1	1		Low - Mode							

The gain setting of the Low-mode is done.

3. DC Sensitivity setting (Reference)

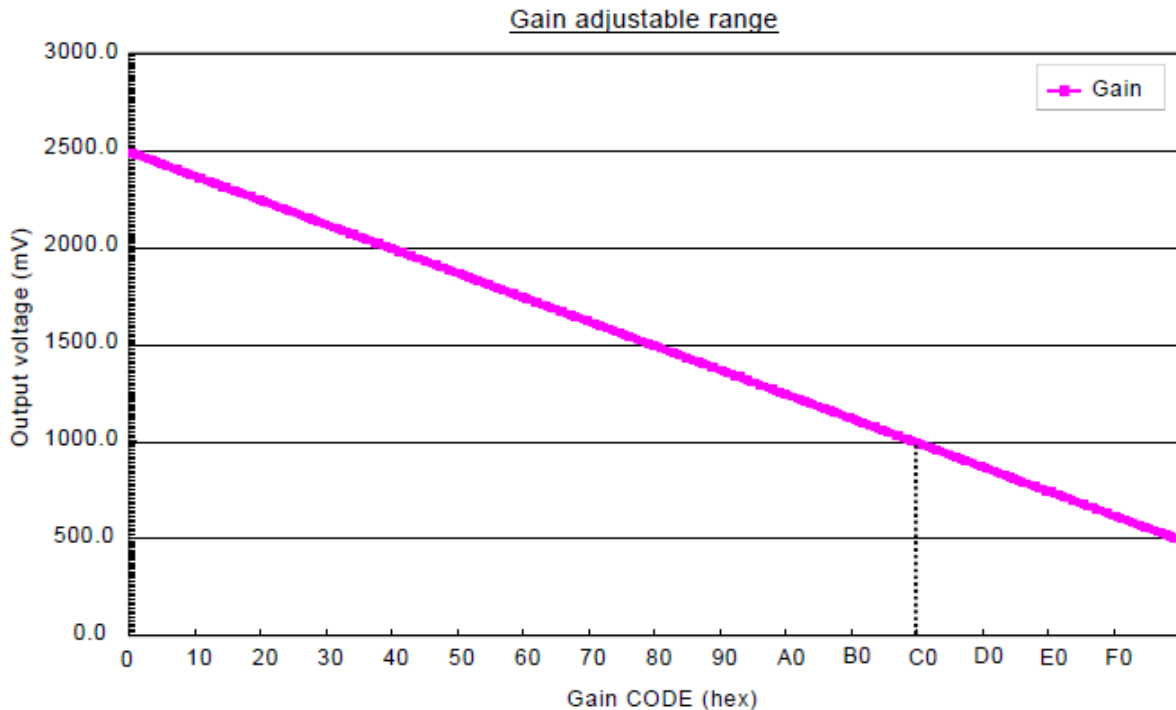

The gain can be adjusted within the range of +7.8 dB from -6 dB based on BFh (0 dB). Vertical axis is plotted Gain. This chart shows that Vout-P–Vout-N is 1V at BFh.

■ Visual Inspection Standard

- Visual inspection is executed to find out the foreign particles or spots on the PD element, externals related to electricity or optical characteristic defect.
- Inspection equipment: With magnifying glass (×4)

Item		Limit standard
Foreign particles Spots Scratches on surface	On the PD element	The foreign particles, spots or scratches of 0.1 mm~0.2 mm × 0.1 mm ~0.2 mm are OK up to 1. The foreign particles, spots or scratches within 0.1 mm × 0.1 mm are OK up to 4. No movable foreign particles.
	The Other parts	The foreign particles, spots or scratches of 0.25 mm~0.5 mm × 0.25 mm~0.5 mm are OK up to 2. The foreign particles, spots or scratches within 0.25 mm × 0.25 mm are OK up to 4. No movable foreign particles.
Void or lacks of resin Bubbles	On the PD element	The voids, lacks or bubbles of 0.1 mm~0.2 mm × 0.1 mm~0.2 mm are OK up to 1. The voids, lacks or bubbles within 0.1 mm × 0.1 mm are OK up to 4.
	The Other parts	The voids, lacks or bubbles of 0.25 mm~0.5 mm × 0.25 mm~0.5 mm are OK up to 2. The voids, lacks or bubbles within 0.25 mm × 0.25 mm are OK up to 4.
Delaminations of resin Crack	All parts of the resin	No cracks or delaminations identified with magnifying glass inspection of all aspects of the package.
Signs of mold lubricant	All parts of the resin	Signs of the mold lubricant on the aspects of package are all acceptable.

(About signs of mold lubricant)

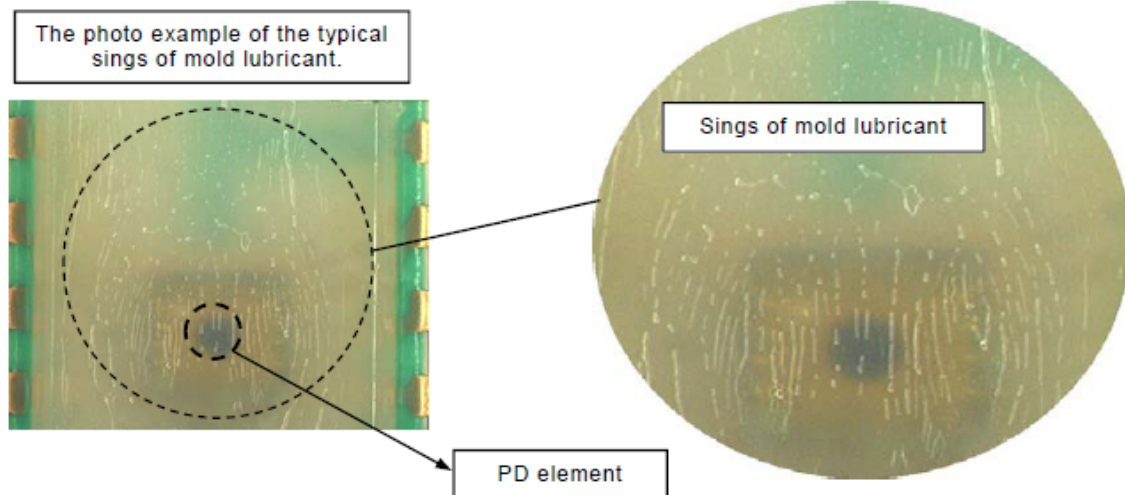

The ruggedness on the surface of the resin seen in the photograph above is the signs of the mold lubricant, not scratches.

To improve friction of the resin when molding is built, mold lubricant is coated.

Finally, As it all numbers is executed for an optical or electricity characteristic inspection, there is no problem for the performance.

When the doubt of other externals is caused, it is assumed the one on which it separately confers.

Outline

Unit:mm

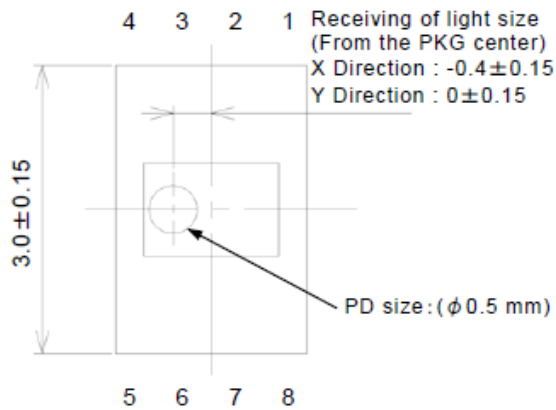

Item	Contents
Pin Material	Cu
Mold Material	Epoxy
Print Board Material	BT Resin
Pin Process	Ni and Au plate

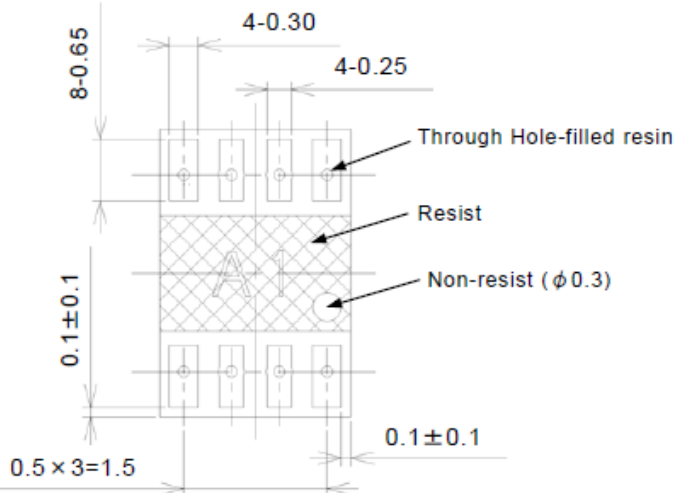
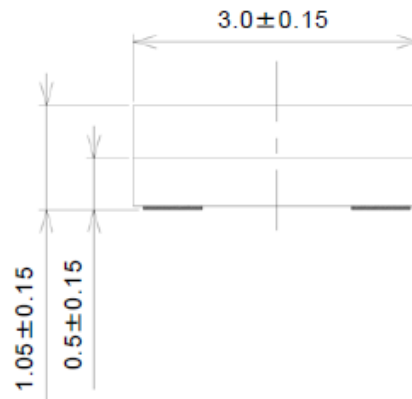
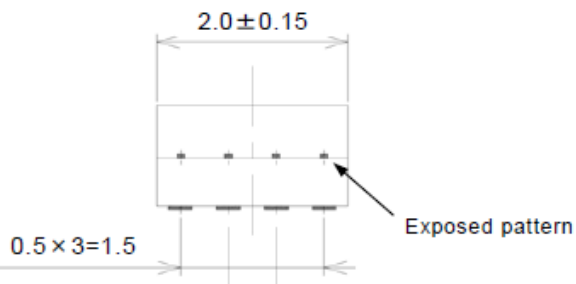

- 1: GND
- 2: SEN
- 3: SDIO
- 4: SCLK
- 5: NC(GND)
- 6: Vout-N
- 7: Vout-P
- 8: Vcc

- (Note1) Dimension tolerance without instructions should be ± 0.075 mm.
- (Note2) Cutting pattern rest: Max. 0.1 mm
- (Note3) Isolate electrically: both end sides of 3.0 mm direction.
- (Note4) Please do not connect the Pin No.5 NC terminal with the ground.

■ Recommended Soldering Conditions

1. Reflow soldering

Show recommendable conditions.

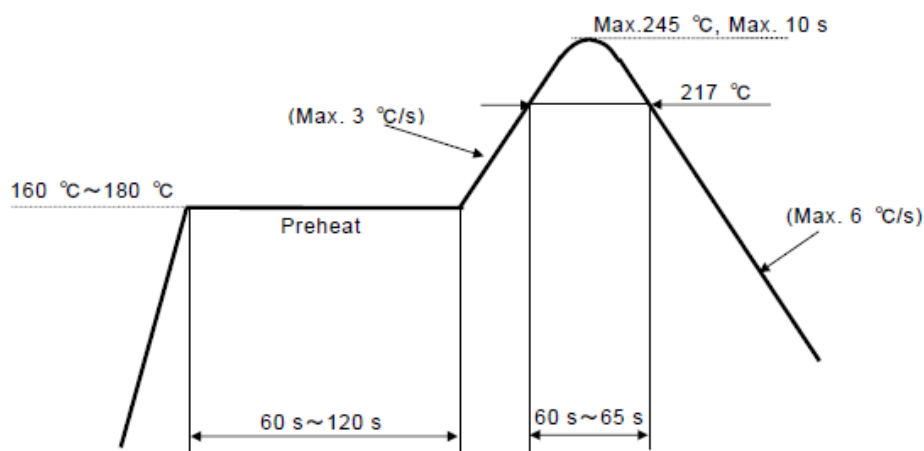

(Soldering time : Maximum 1 time)

It is temperature profile at surface of printed board.

2. Hand soldering

- Please use the soldering iron within 350 °C and 3 s. (1 time)
It's recommended to use soldering iron with temperature controller.
- Please don't give mechanical stress to the package or the terminal when soldering.
Especially, please be careful pattern disconnection, because gold pattern is weak to mechanical stress.
- Do not also give a mechanical stress to the device and the board adjusted right after soldering.
(Please avoid reusing the product to which once has been mounted.)

■ Handling Instructions

1. Storage limit of un-opened product

To prevent humid absorption while transporting or storing the product, humidity proof packing is made using a Al laminate bag (with a silica gel).

Pay attention because that a indicator in a silica gel change color.

Be complete to unseal every 1 bag and carry out reflow soldering promptly, because moisture absorption of a product advances rapidly and characteristic defectiveness occurs by a heat stress of reflow soldering in the case that it is worst.

It is recommended the product be used within a year.

Storage condition: Un-opened, 10 °C~30 °C, less than 60 %RH

2. Storage limit of opened product

Humidity proof packing is made using a Al laminate bag (with a silica gel).

After unpacking, It is recommended the product be used within 48 h under 10 °C~30 °C and less than 60 %RH.

3. Baking processing of to that eliminates humidity

The product that passed total 48 hours after unpacking, it must be baked in the following condition before soldering.

1). Storage condition

·Temperature: 10 °C~30 °C, Humidity: under 60 %

2). Baking

·The product without taping.

Baking condition ... 115 °C/4 h~5 h.

And baking should be one time.

·The products with taping.

Baking condition ... 90 °C/24 h~36 h

And baking should be one time.

However, the product that passed 48 h~72 h after opening the aluminum lamination bag can do baking processing only one times at 50 °C~60 °C, 72 h~96 h.

(Note)

The poor characteristic may generate on the products when a great deal of neglect time after the opening in your process.

Also under the products with taping, there is a possibility that the strength of cover tape peeling fluctuates and the mounting error occurs after baking.

Therefore, please take sufficient advance checks and control in your process.

Meanwhile, please note that we are not responsible for the problem occurred except in the condition above.

4. Cleaning

- Do not wash the product which is to be reflow soldering.
- Enforce in the following condition without fail when a washing is done after reflow soldering.
 - (1) Alcohol is recommended for cleaning.

Do not use a chlorine solvent, which may cause damage to the epoxy and product and deterioration of the elements.
 - (2) The condition of "below 28 kHz/10 W per liter and within 30 s" is generally recommended for ultrasonic, cleaning, however, please confirm that the test result on mounting condition after assembly has no problem before it's actually adapted.
 - (3) Avoid the use of brushing because it sometime damages detector surfaces.

5. Noise

Please consider that the use in the place where the influence can be predicted by the noise.
(Electromagnet Noise, power supply noise, outside rebellion light noise etc.)

6. Static electricity

- Take the adequate static electricity measures .

Give the static electricity measures that is enough at use consideration.

 - (1) Please earth the user when the products are handled by Hand.
 - (2) Do not insert or remove the products when the source voltage is supplied, otherwise it would break them.
 - (3) Please insert the terminal in place, otherwise the product would be broken.

If it's once inserted improperly, please do not use it.

7. Others

- Do not add an abnormal voltage such as reverse voltage, over shoot voltage, under shoot voltage, etc.
- Photo-IC is the product which easy to be influenced by the noise.

Therefore, it may be affected by the perimeter circuit and the change of electronic parts to have an operation problem.
Careful study and discussion are required in the case of specification change.
- Optical-electrical characteristics are guaranteed as being based on our measurement condition.

Consequently, please check it sufficiently with your set for use.
- Please note that the stress doesn't join the product when it mounts on the set substrate etc. , and the substrate is divided.

The back electrode peels off when an excessive stress joins and it becomes destruction.

■ Thermal Stress to Optical Device

Since light transmissivity is important for the package resin of optical devices (LED's, photodiodes, photo ICs, Photosensors, photocouplers), it is necessary for resin to contain additives in it.

For this reason, it has a lower thermal deformation temperature, compared with the package resin for ICs, LSI's and so on and is in the vicinity of the maximum storage temperature.

Unless it is designed under the operating conditions, taking into an operating current and ambient conditions into account, the optical devices may be destroyed due to thermal stress caused to the operating optical devices and this may cause lower light output and disconnection.

■ Guarantee

The warranty will be valid only within the reliability test results or the items and terms of the reliability assurance standard.

It is also limited to that of the delivered product itself and we are not responsible for the labor cost for replacement work, compensation for loss and the like.

The following cases are onerous since they are out of our guarantee even during the guarantee period:

- Troubles resulting from careless handling or erroneous use.
- Troubles resulting from unreasonable repair or improvement.
- Troubles resulting from irresistible force such as natural disasters.

Should there be any doubt, we will verify it to clarify the cause in the presence of both parties in principle and take a proper action.

■ Others

1) For matters on quality agreed between you and as those mentioned in these delivery specifications only are valid basically and matters decided between you and us before the receipt of these specifications become invalid unless they are mentioned in these specifications.

But, if any inadequacy is present, we are ready for a discussion with you to settle the matter.

In case any modification is required after the receipt of those specifications, only matters agreed by you and us are valid.

2) For a special application or question, contact us before the fact and without delay.

3) Though we will deliver the products for which we guarantee the matters on quality mentioned in these specifications, please investigate on your side the incorporation into actual sets, duration under actual working conditions and other matters on quality of the products sufficiently.

4) If these delivery specifications are not returned to us within two weeks after the issue, we regard them as received, which please understand.

5) For the doubts or necessity of change in this specification, mutual discussion will be made for the solution

6) UL Standard

Since epoxy resin which is superior in optical characteristics is adopted for the LED, UL standard is not gained.

7) The specifications will be changed after prior discussion.

8) This product is RoHS-free supported.

■ Taping form and Dimensions

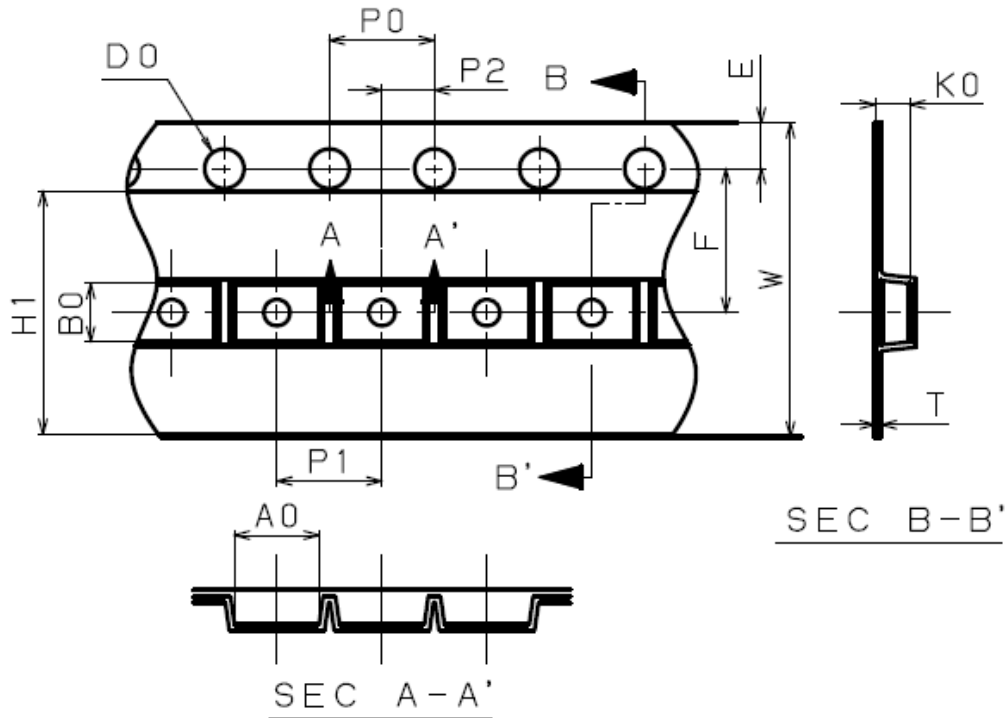

Unit : mm

Item	Symbol	Dimensions	Remarks	
Dented square hole for product insertion	Length	A0	3.23±0.1	
	Width	B0	2.23±0.1	
	Depth	K0	1.32±0.1	
	Pitch	P1	4.0±0.1	Accumulated error ±0.2 max/10 pitches
Sprocket hole	Diameter	D0	1.5 $\begin{smallmatrix} +0.1 \\ -0.0 \end{smallmatrix}$	
	Pitch	P0	4.0±0.1	Accumulated error ±0.2 max/10 pitches
	Position	E1	1.75±0.1	
Center-to-center distance	Longitudinal	P2	2.0±0.1	
	Traverse	F	5.5±0.1	
Cover tape	Width	H1	9.3±0.1	
	Material	Polyester Anti-static		
Carrier tape	Width	W	12.0±0.3	
	Thickness	T	0.23±0.05	
	Material	Polycarbonate + Carbon Anti-static		

■ Reel and Dimensions

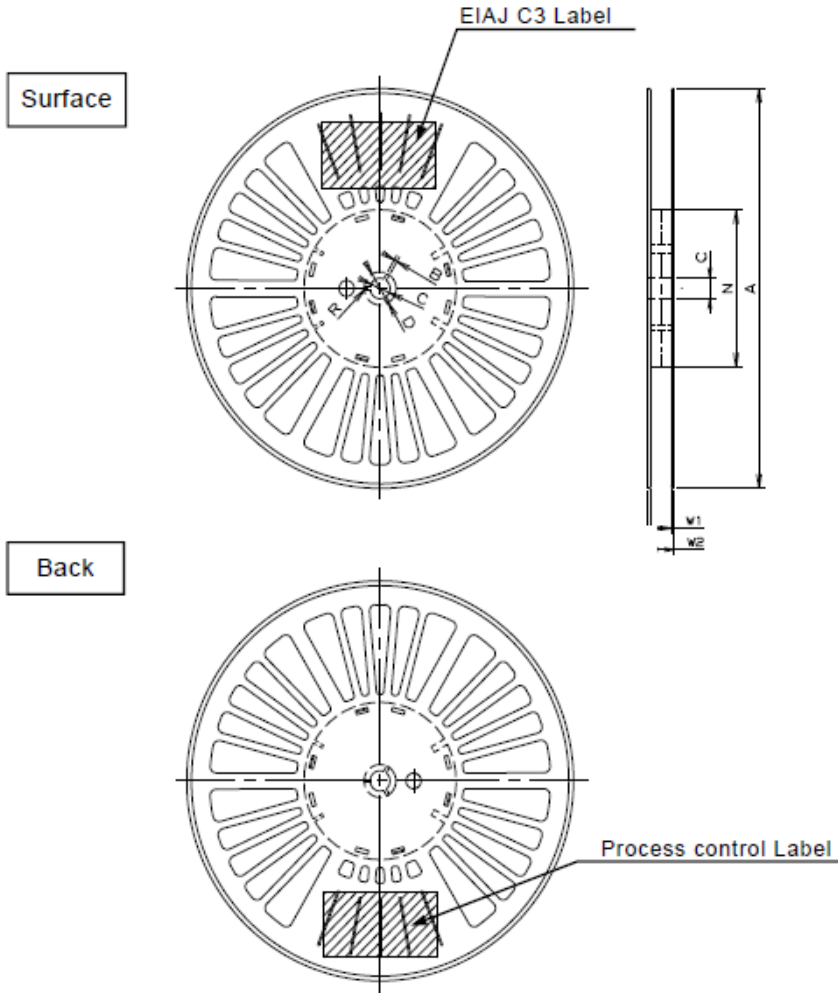

Unit:mm

※The designs of the reel other than the size description part are assumed to be pretermission.

Item		Symbol	Dimensions	Remarks	
Flange	Diameter	A	180±2.0		
	Inner width of flanges	W1	13.5±1.0		
	Outer width of flanges	W2	17.1±1.0		
Hub	Outer diameter	N	60±1.0		
	Spindle hole diameter	C	13.0±0.2		
	Keyway	Width	E	2.0±0.5	
		Depth	D	21.0±0.8	
Radius at corner		R	1.0±0.2		
Material	PPE	Anti-static			
Indication of the name etc.	To be printed on the side of a flange.				
	Name, Quantity, Serial No. etc are to be shown.				

■ **Structure**

1) Structure and Dimensions

It is conformed to IEC 60286.

(Structure)

- ① Carrier tape For dimensions, refer to sheet No.1.
- ② Cover tape For dimensions, refer to sheet No.1.
- ③ Reel For dimensions, refer to sheet No.2.

(Structure of taping)

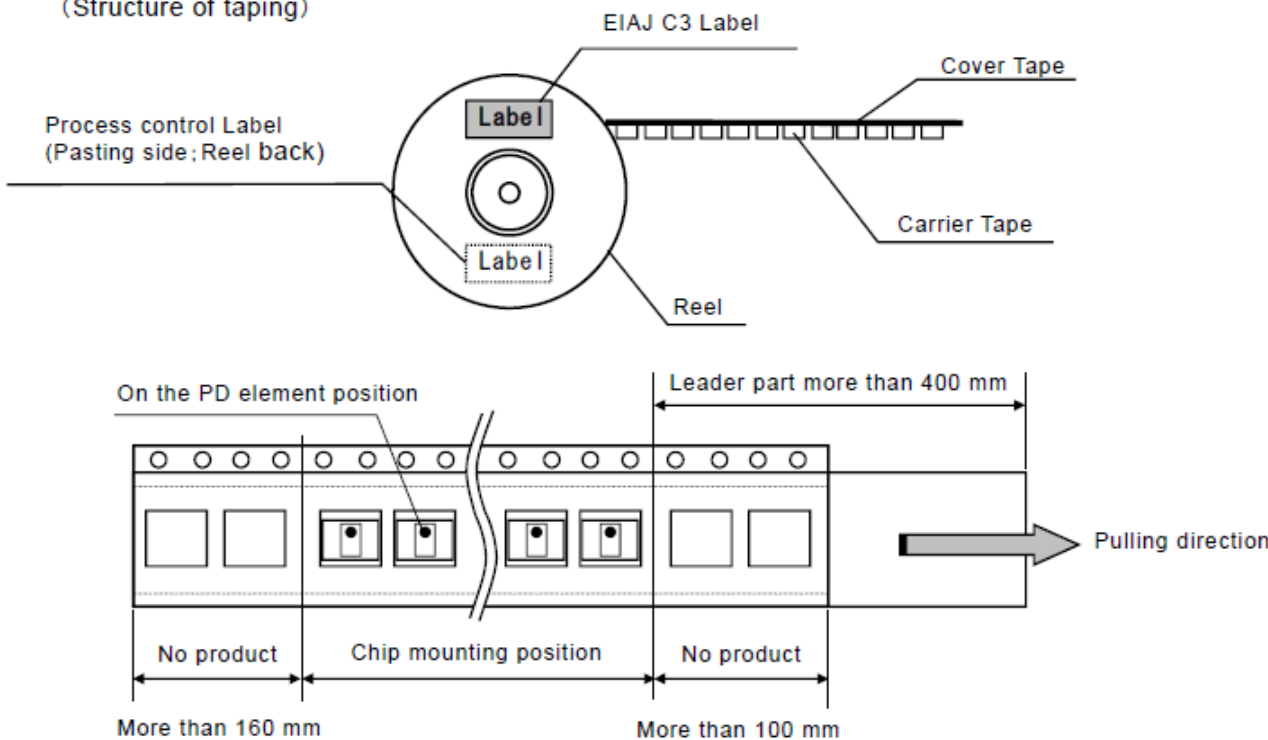

- The sprocket holes shall be on the right side against the pull-out direction.
- The space of more than 100 mm shall be provided on each front of the tape mounting.
- The space of more than 160 mm shall be provided on each rear of the tape mounting.
- The leader of more than 400 mm by the cover tape shall be provided at the front portion of the pull-out.

■ **Quantity and indication on the package.**

1) Taping quantity

The standard quantity shall be 2 500 pcs/reel.
2 reels shall be packed in the specified carton box.

2) Indication

The type, quantity, serial No. shall be shown on the side of the reel.

■ Mechanical characteristics and specifications

1) Peeling strength of cover tape.

$F=0.2\text{ N} \sim 0.7\text{ N}$ (Measured by peel back tester)

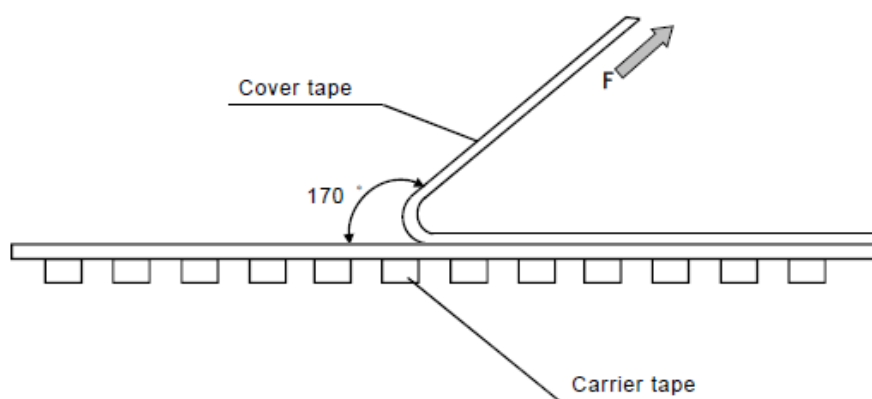

2) Specifications

- When the tape is bent to radius 30 mm, the products do not fall down from the tape and the tape doesn't get any damage.
- During the peeling, the products shall not stick to the cover tape.
- The taped products shall not be turned upside down, reversed or partial absence in the arrangement of the product.

■ Packing Specification

1) Reel

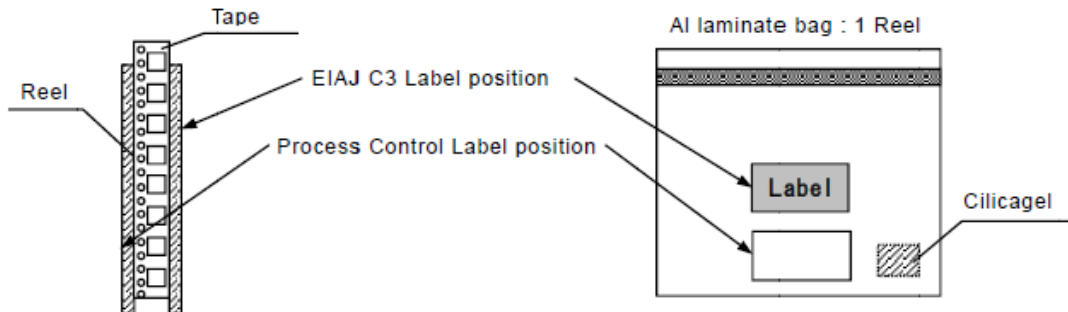

2) Carton

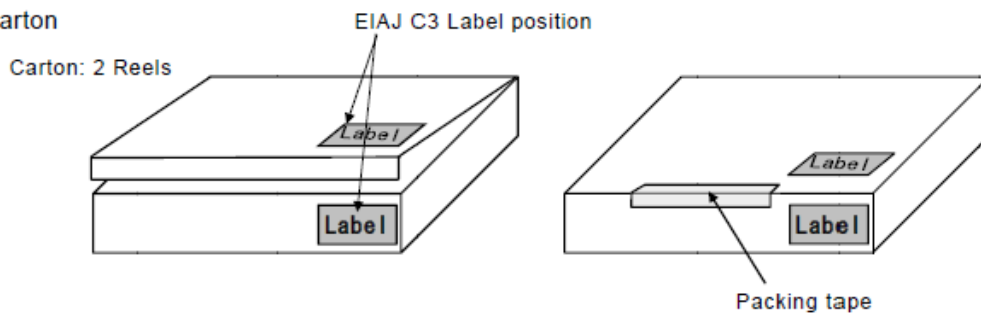

3) Packing Case

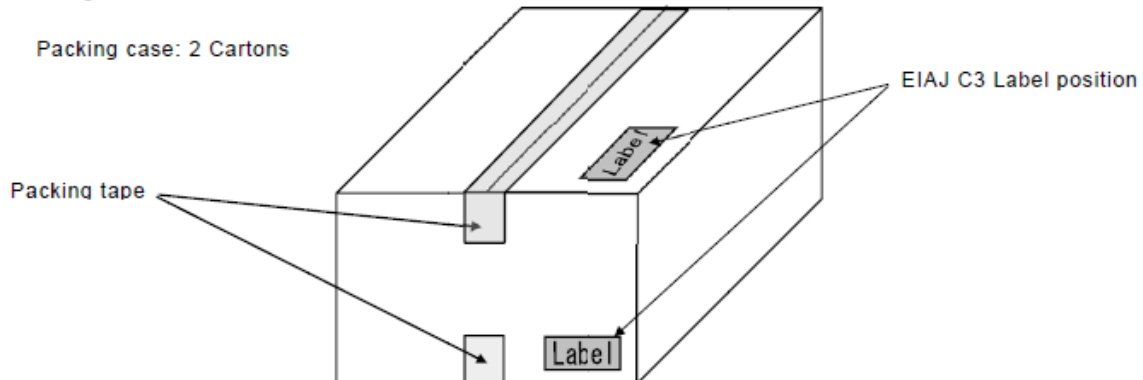

4) Quantity & Contents

Form	Quantity	Contents	Material
Al laminate bag	2 500 pcs	1 Reel	Al
Carton	5 000 pcs	2 Reels	Corrugated paper
Packing case	10 000 pcs	2 Cartons	Corrugated paper

(Note1) Type No., the quantity, and production date (Date code) are printed on the label.

(Note2) Please refer the product traceability with date code on the packing label.

1	Print a proper product name in principle. [PNA4U62F]
2	The number indicates the following : 1317 (17-March.2011) Provided that, an English initial is used in <u>D</u> ecember <u>N</u> ovember <u>O</u> ctober.

Label indication

1) Label specification: EIAJ-C3

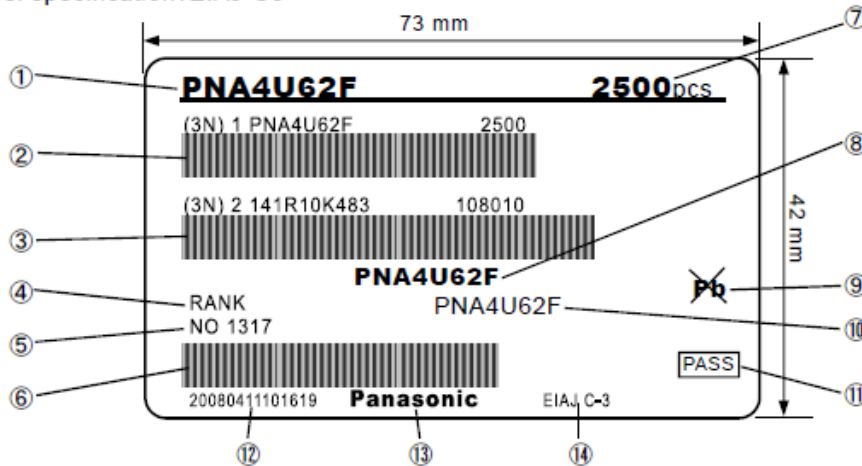

No.	The Contents of display	Contents explanation
①	Order person part number	Part number of a user setup Etc.
②	The first step bar code	[(3N)1]+[Order person part number]+[Space]+[Quantity]
③	The second step bar code	[(3N)1]+[Space]+[Serial number]+[Space]+[108010]
④	Rank	Rank
⑤	Date code	Product date code
⑥	The third step bar code	[1P]+[Panasonic unification part number]
⑦	Quantity	Quantity of package
⑧	Panasonic unification part number	Panasonic group unification part number
⑨	Lead free mark	Indicate the lead free product
⑩	Panasonic part number	Panasonic semiconductor company part number
⑪	Shipment acceptable display	—
⑫	Printing time	—
⑬	Brand mark	—
⑭	EIAJ-C3 display	(Only a not packing case is displayed.)

《Serial number》

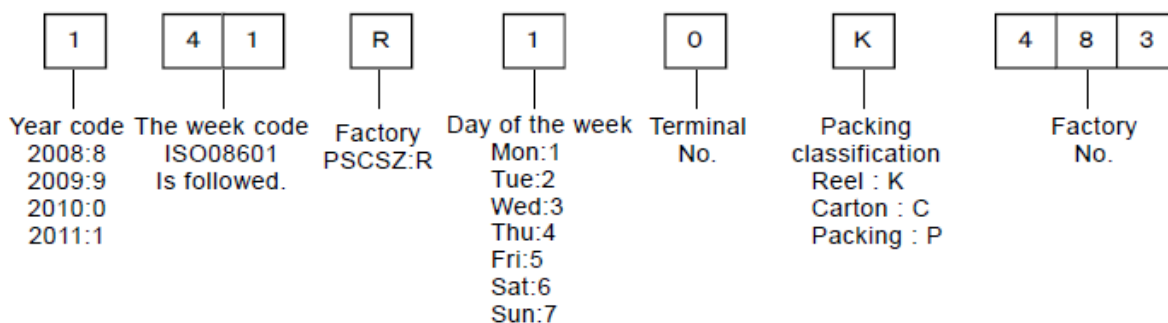

2) Production control label

<Reference>

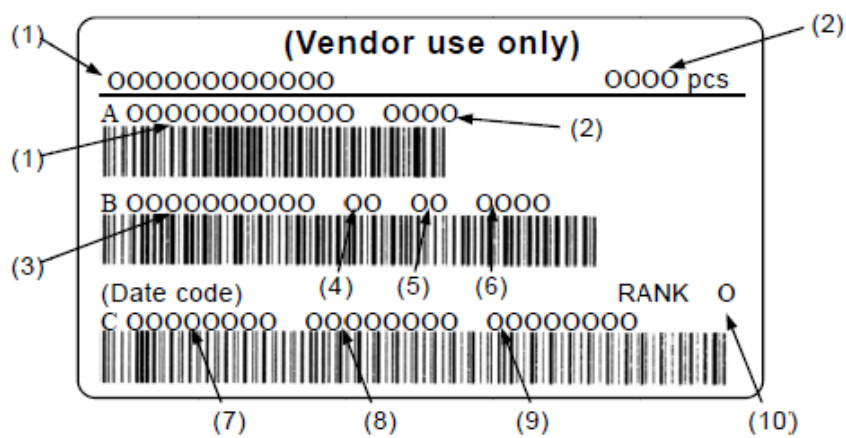

(1)	SC Type name	(6)	Inside pack code
(2)	Quantity	(7)	Date code
(3)	Assemble Lot No	(8)	Date code
(4)	Department code	(9)	Date code
(5)	Ridge code	(10)	Rank

Bar code "B" Detailed explanation
 Department code : 40 (Dis)
 Ridge code : A (Nagaoka)
 Inside pack code : No setting.

■ Place of production

Diffusion Factory : TowerJazz Panasonic Semiconductor Co., Ltd.

Address : 800 Higashiyama, Uozu-city, Toyama, Japan

Assembly Factory : Panasonic Semiconductor Suzhou Co., Ltd.

Address : No.666 Lushan Road,Suzhou New District Jiangsu Proviince,China

■ Country of origin

Diffusion : Japan

Assembly : China

Product Name : PNA4U62F

Issued by	Reaffirmed by
Panasonic Semiconductor Solutions Co., Ltd. Global Quality Assurance Center	

◆ Reliability Assurance Criterion (MIL-STD-19500H LTPD 15 %)

Test items	Test conditions	Test results	Judgment criteria
High Temperature Bias Operating Life Test	※1) Ta=75 °C, Vcc=5.0 V, t=1 000 h	0/15	Refer to the following and the failure criterions.
High Temperature Humidity Bias Operating Life Test	※1) Ta=60 °C, RH=90 %, Vcc=5.0 V, t=500 h	0/15	
High Temperature Humidity Storage Test	※1) Ta=60 °C, RH=90 %, t=1 000 h	0/15	
High Temperature Storage Test	※1) Ta=85 °C, t=1 000 h	0/15	
Low Temperature Storage Test	※1) Ta=-40 °C, t=1 000 h	0/15	
Thermal Shock Test	※1) Ta = -40 °C ~ 85 °C , 100 Cycles (30 min) (30 min)	0/15	
Reflow Soldering Heat Resistance Test	Test for 1 time under the condition described in Product specification sheet No.14/11	0/15	
Solderability Test	Pre processing : Ta=85 °C, RH=85 %, t=16 h Refer to Reflow profile Product specification sheet No.14/11 Reflow : 1 time	0/15	
Drop Test	Drop distance : 1 m Drop the device 3 times on a maple board of 3 cm or more in thickness.	0/15	
Static Electricity Resisting Pressure Test	C=100 pF, RL=1.5 kΩ, 3 Shots, 1 s Min. ±2 000 V (MIL-STD-19500H LTPD:50 %)	0/5	

※1) This test is done after pre processing Ta=30 °C, RH=60 %, t=48 h, 1time reflow at sheet No.14/11's condition.

◆ Failure Criterion

Electrical Characteristics				
Item	Symbol	Criterion (Note)		Unit
		Lower Limit	Upper Limit	
Output voltage sensibility rate of change	Δ Gain1 (*1)	-50	+50	%
	Δ Gain2 (*1)	-50	+50	%
	Δ Gain3 (*1)	-50	+50	%
Appearance, etc				
Appearance	According to visual spec			
Rusting, Discoloring	No rusting, discoloring (Terminal)			
Solderability	Solder adheres by 90 % or more of area of electrode terminal.			

(Notes) If you have any special requirement, please inquire for us.

(*1) It doesn't contain the measurement error.

Request for your special attention and precautions in using the technical information and semiconductors described in this book

- (1) If any of the products or technical information described in this book is to be exported or provided to non-residents, the laws and regulations of the exporting country, especially, those with regard to security export control, must be observed.
- (2) The technical information described in this book is intended only to show the main characteristics and application circuit examples of the products. No license is granted in and to any intellectual property right or other right owned by Panasonic Corporation or any other company. Therefore, no responsibility is assumed by our company as to the infringement upon any such right owned by any other company which may arise as a result of the use of technical information described in this book.
- (3) The products described in this book are intended to be used for general applications (such as office equipment, communications equipment, measuring instruments and household appliances), or for specific applications as expressly stated in this book.
Consult our sales staff in advance for information on the following applications:
 - Special applications (such as for airplanes, aerospace, automotive equipment, traffic signaling equipment, combustion equipment, life support systems and safety devices) in which exceptional quality and reliability are required, or if the failure or malfunction of the products may directly jeopardize life or harm the human body.It is to be understood that our company shall not be held responsible for any damage incurred as a result of or in connection with your using the products described in this book for any special application, unless our company agrees to your using the products in this book for any special application.
- (4) The products and product specifications described in this book are subject to change without notice for modification and/or improvement. At the final stage of your design, purchasing, or use of the products, therefore, ask for the most up-to-date Product Standards in advance to make sure that the latest specifications satisfy your requirements.
- (5) When designing your equipment, comply with the range of absolute maximum rating and the guaranteed operating conditions (operating power supply voltage and operating environment etc.). Especially, please be careful not to exceed the range of absolute maximum rating on the transient state, such as power-on, power-off and mode-switching. Otherwise, we will not be liable for any defect which may arise later in your equipment.
Even when the products are used within the guaranteed values, take into the consideration of incidence of break down and failure mode, possible to occur to semiconductor products. Measures on the systems such as redundant design, arresting the spread of fire or preventing glitch are recommended in order to prevent physical injury, fire, social damages, for example, by using the products.
- (6) Comply with the instructions for use in order to prevent breakdown and characteristics change due to external factors (ESD, EOS, thermal stress and mechanical stress) at the time of handling, mounting or at customer's process. When using products for which damp-proof packing is required, satisfy the conditions, such as shelf life and the elapsed time since first opening the packages.
- (7) This book may be not reprinted or reproduced whether wholly or partially, without the prior written permission of our company.