

2-line, ultralow capacitance protection in 0.3 mm pitch

Datasheet - production data

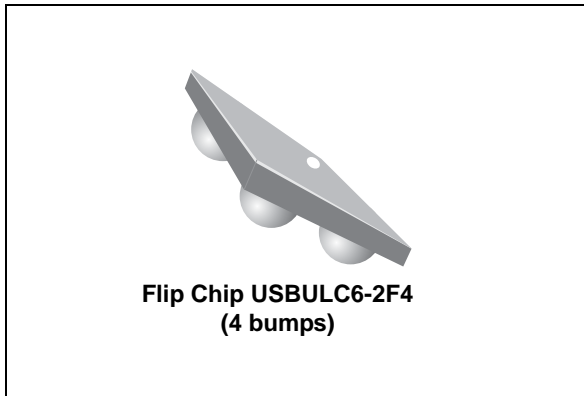

Description

The USBULC6-2F4 is a monolithic, application specific discrete device dedicated to ESD protection of high speed interfaces.

Its ultralow line capacitance secures a high level of signal integrity without compromising the protection of downstream sensitive chips against the most stringently characterized ESD strikes.

Figure 1. Pin layout (bump side)

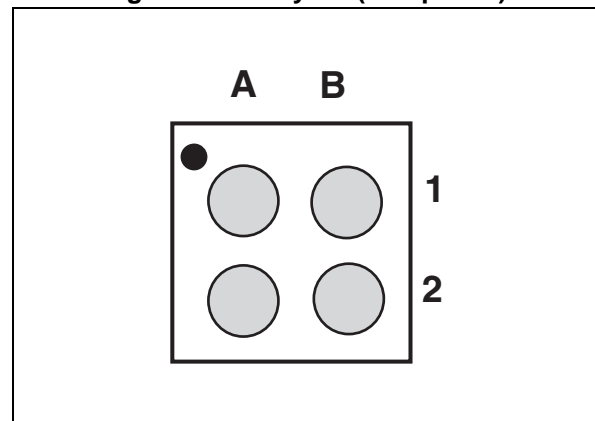

Features

- Ultralow capacitance diode (1.5 pF max)
- 0.3 mm pitch
- Two data lines (D+ and D-) protected against ESD
- Breakdown voltage $V_{BR} = 6.0 \text{ V min.}$
- Flip Chip, 300 μm pitch, lead-free
- Very low leakage current
- Very small PCB area
- RoHS compliant

Benefits

- Minimized impact on rise and fall times for maximum data integrity
- Low PCB space occupation
- Higher reliability offered by monolithic integration

Complies with the following standards

- IEC 61000-4-2 level 4:
 - $\pm 15 \text{ kV}$ (air discharge)
 - $\pm 8 \text{ kV}$ (contact discharge)

Figure 2. Device configuration

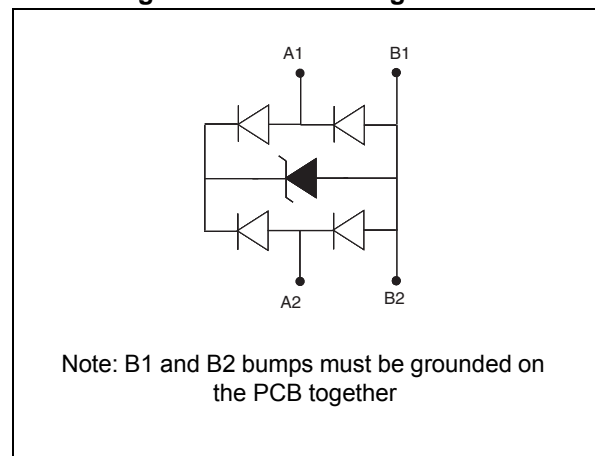

1 Characteristics

Table 1. Absolute maximum ratings ($T_{amb} = 25\text{ }^{\circ}\text{C}$)

Symbol	Parameter	Value	Unit
V_{PP}	IEC 61000-4-2, level 4, contact discharge	± 8	kV
P_{PP}	Peak pulse power dissipation (8/20 μs)	60	W
T_j	Maximum junction temperature	125	$^{\circ}\text{C}$
T_{op}	Operating temperature range	-30 to + 85	$^{\circ}\text{C}$
T_{stg}	Storage temperature range	-55 to +150	$^{\circ}\text{C}$

Figure 3. Electrical characteristics - definitions

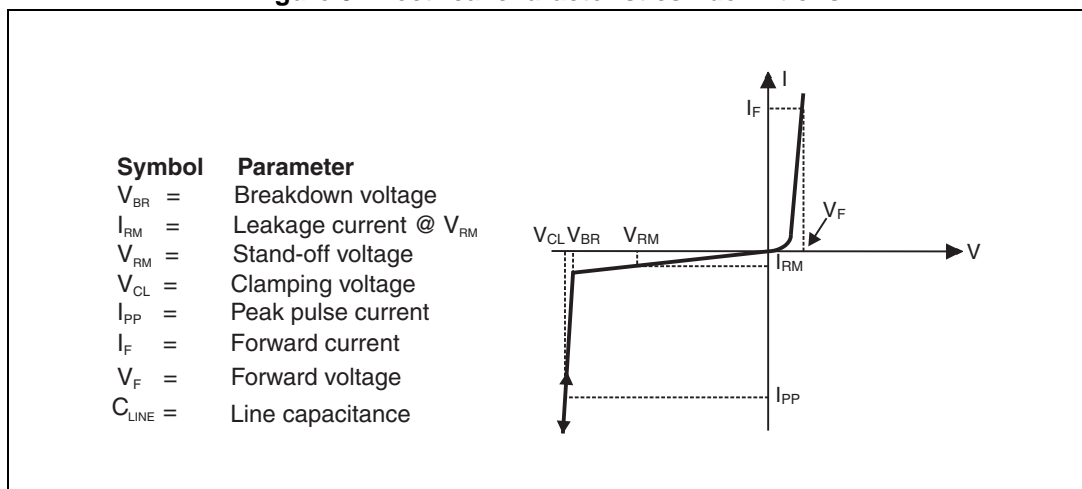

Table 2. Electrical characteristics - values ($T_{amb} = 25\text{ }^{\circ}\text{C}$)

Symbol	Test conditions	Min.	Typ.	Max.	Unit	
V_{BR}	$I_R = 1\text{ mA}$	6	-		V	
I_{RM}	$V_{RM} = 3\text{ V per line}$	-	-	100	nA	
C_{LINE}	$V_{LINE} = 0\text{ V}, V_{OSC} = 30\text{ mV}, F = 1\text{ MHz}$	-	-	1.5	pF	
R_d	Dynamic resistance, pulse duration 100 ns	I/O to GND	-	0.73	-	Ω
		GND to I/O	-	0.72	-	

Figure 4. Eye diagram, board only (according to USB 2.0 high speed specification)

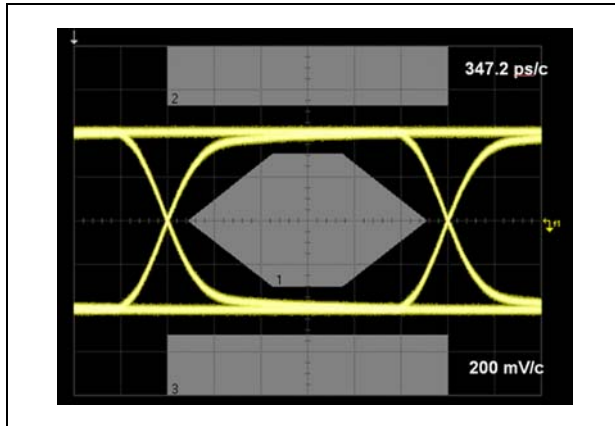

Figure 5. Eye diagram, board with USBULC6-2F4 (according to USB 2.0 high speed specification)

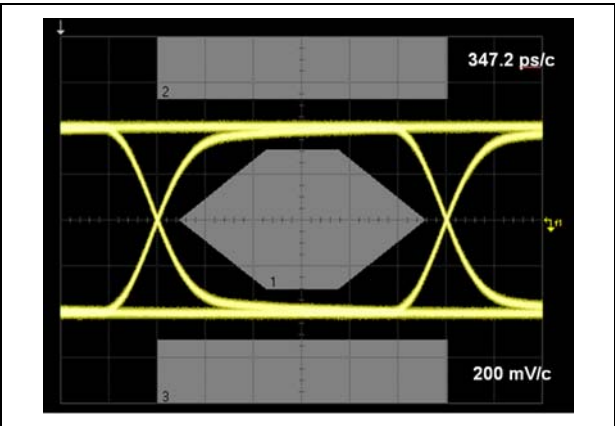

Figure 6. ESD response to IEC 61000-4-2 (+8 kV contact discharge)⁽¹⁾

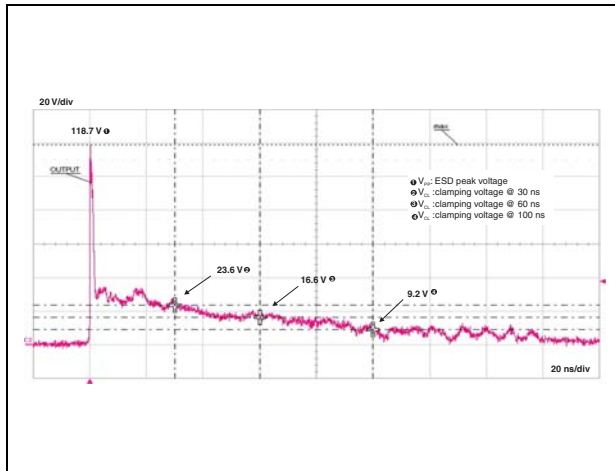
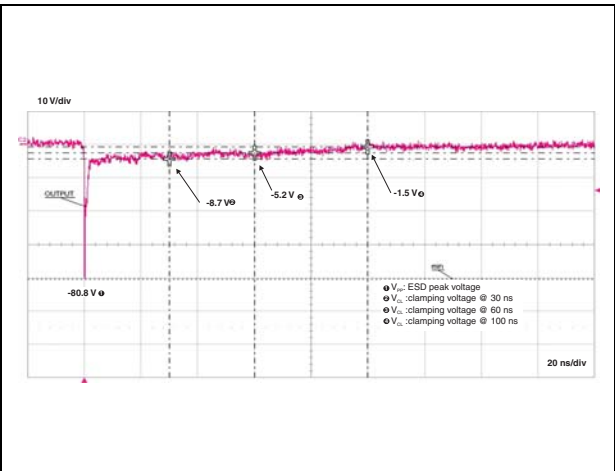

Figure 7. ESD response to IEC 61000-4-2 (-8 kV contact discharge)⁽¹⁾



1. Test board connected with a 50 Ohm cable and 20 dB + 20 dB attenuator to an oscilloscope on 50 Ohm input. ESD generator return path connected to PCB ground plane.

Figure 8. Junction capacitance versus frequency (typical values)

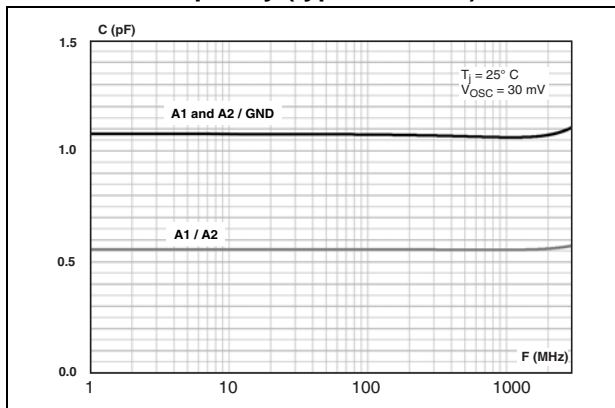

Figure 9. Analog crosstalk versus frequency (typical values)

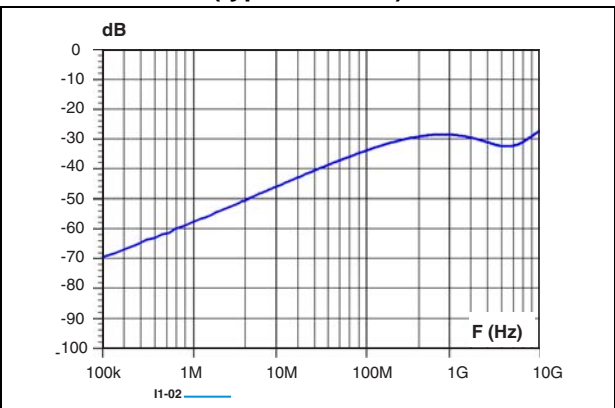

Figure 10. Insertion losses versus frequency

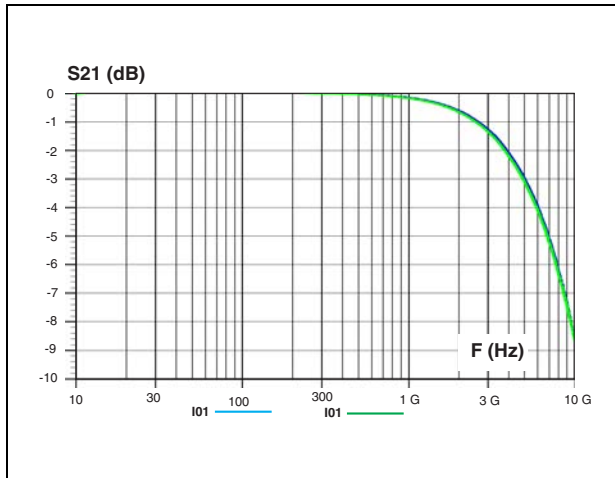

Figure 11. TLP measurement

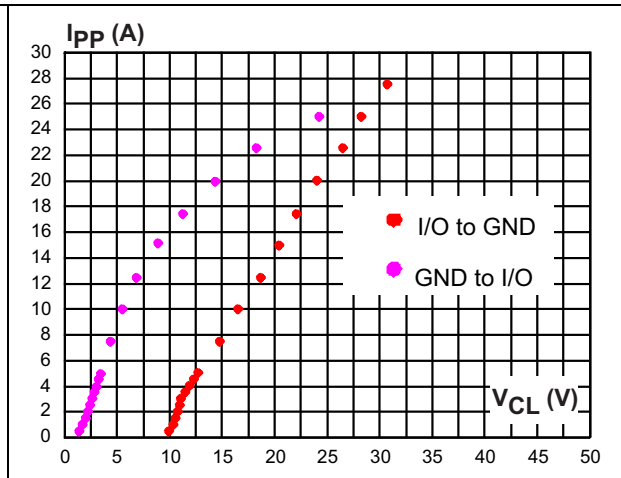

Figure 12. Peak pulse power versus initial junction temperature (maximum values, pulse 8/20 μs)

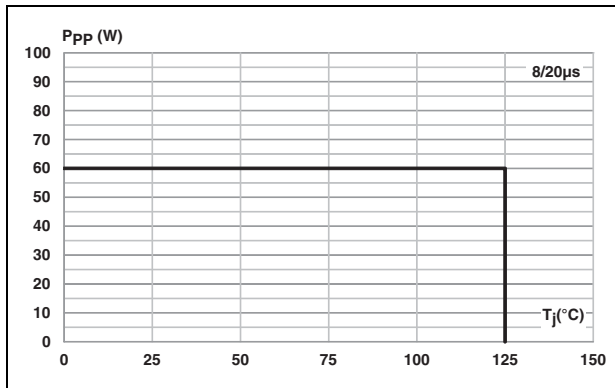

Figure 13. Peak pulse power versus exponential pulse duration (maximum values)

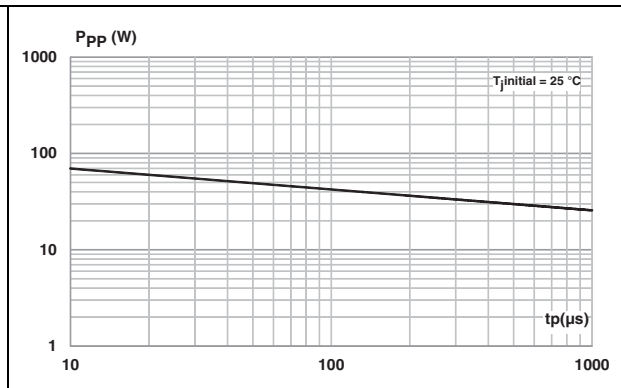

Figure 14. Clamping voltage versus peak pulse current (typical values)

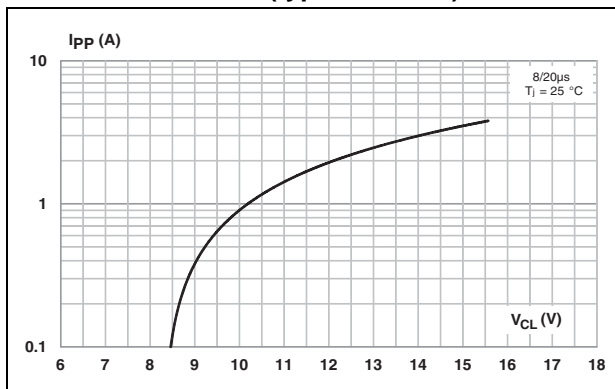
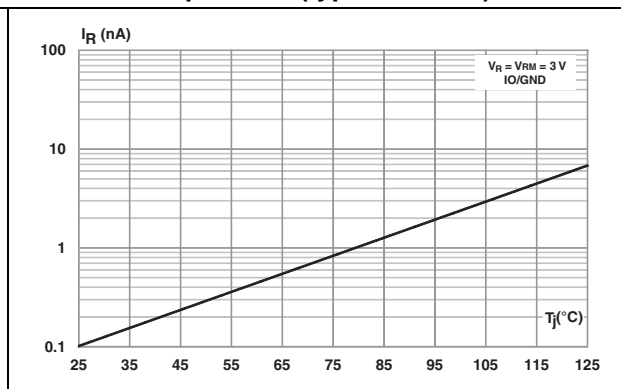

Figure 15. Leakage current versus junction temperature (typical values)



2 Package information

In order to meet environmental requirements, ST offers these devices in different grades of ECOPACK® packages, depending on their level of environmental compliance. ECOPACK® specifications, grade definitions and product status are available at: www.st.com. ECOPACK® is an ST trademark.

Figure 16. Package dimensions

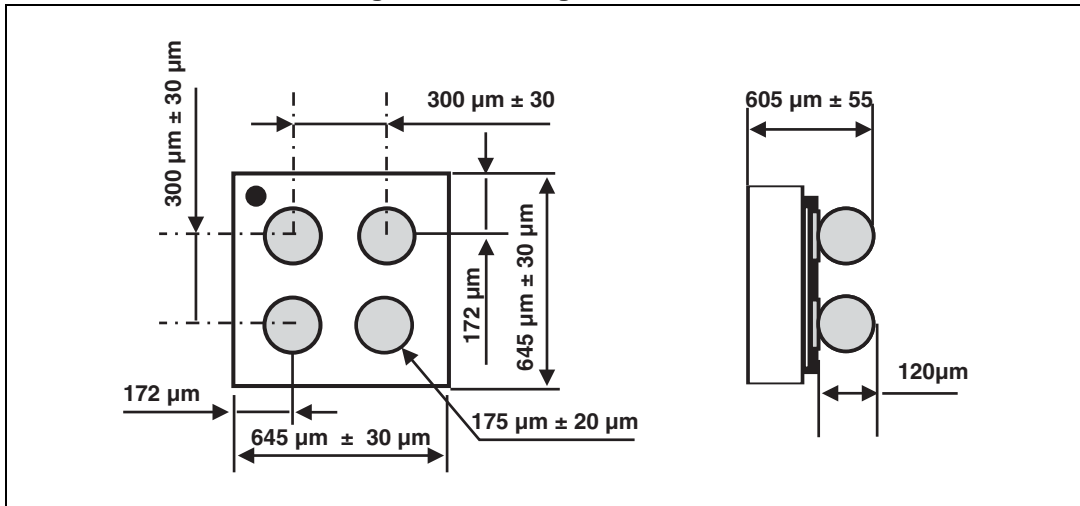

Figure 17. Footprint recommendations

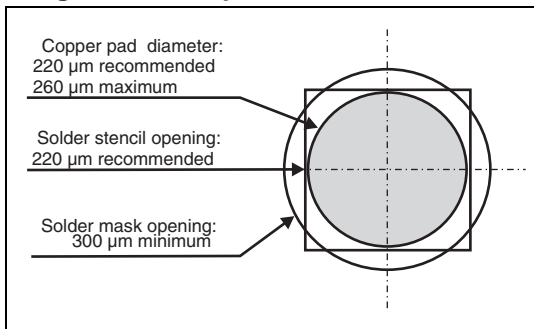

Figure 18. Marking

Dot,
xx = marking

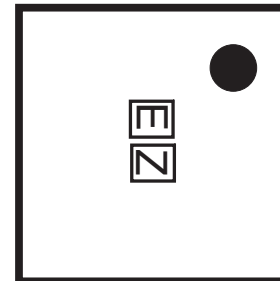
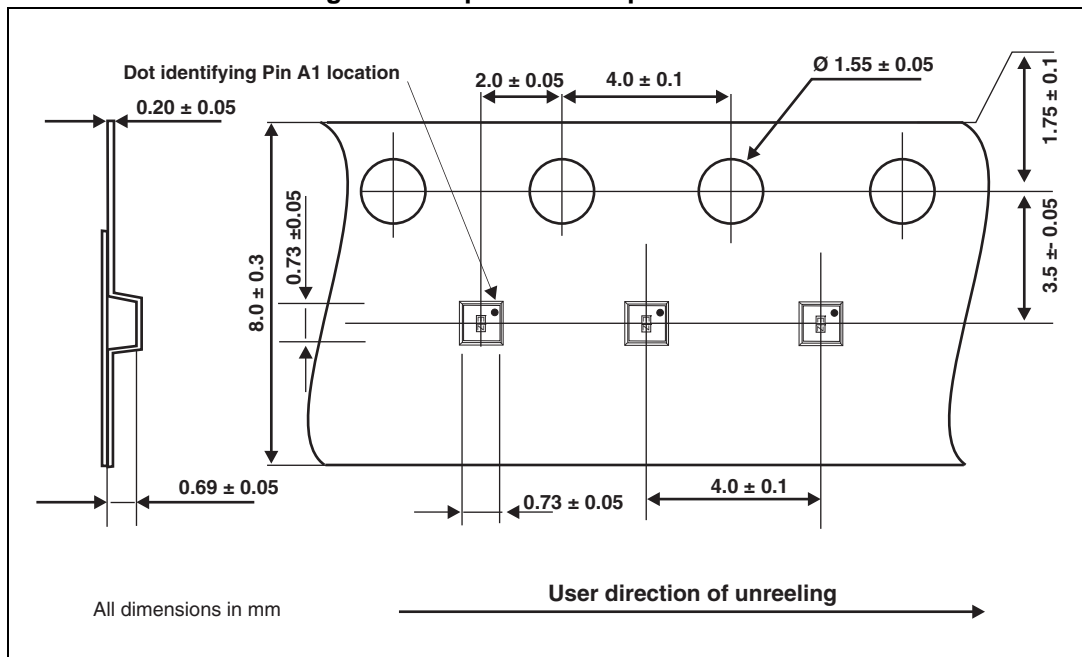

Figure 19. Tape and reel specifications



Note: More information is available in the STMicroelectronics Application notes:
 AN4208: "Flip Chip: Package description and recommendations for use"
 AN1751: "EMI Filters: Recommendations and measurements"

3 Ordering information

Figure 20. Ordering information scheme

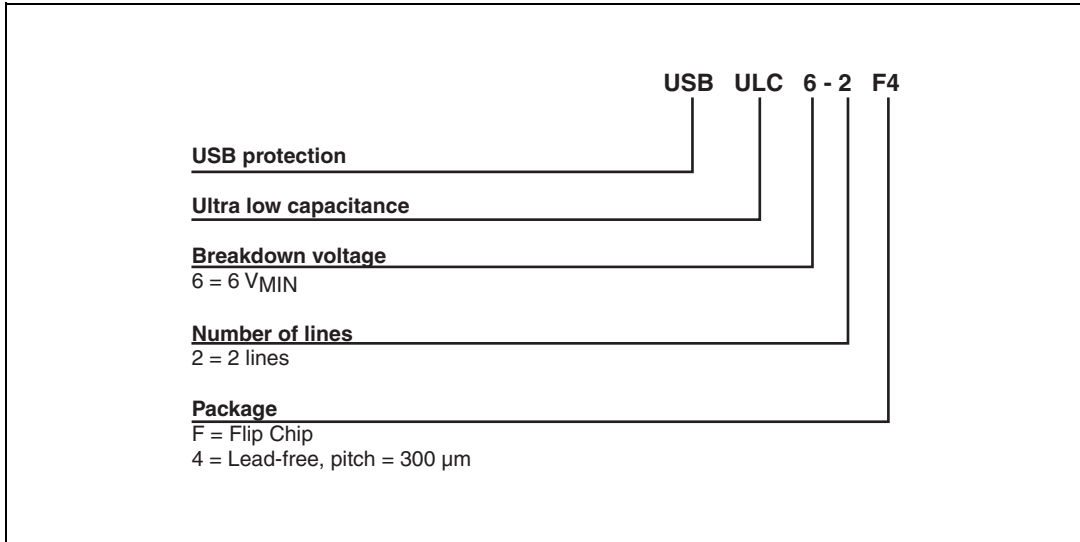

Table 3. Ordering information

Order code	Marking	Package	Weight	Base qty	Delivery mode
USBULC6-2F4	EZ	Flip Chip	0.516 mg	5000	Tape and reel (7'')

4 Revision history

Table 4. Document revision history

Date	Revision	Changes
20-Dec-2013	1	Initial release.

Please Read Carefully:

Information in this document is provided solely in connection with ST products. STMicroelectronics NV and its subsidiaries ("ST") reserve the right to make changes, corrections, modifications or improvements, to this document, and the products and services described herein at any time, without notice.

All ST products are sold pursuant to ST's terms and conditions of sale.

Purchasers are solely responsible for the choice, selection and use of the ST products and services described herein, and ST assumes no liability whatsoever relating to the choice, selection or use of the ST products and services described herein.

No license, express or implied, by estoppel or otherwise, to any intellectual property rights is granted under this document. If any part of this document refers to any third party products or services it shall not be deemed a license grant by ST for the use of such third party products or services, or any intellectual property contained therein or considered as a warranty covering the use in any manner whatsoever of such third party products or services or any intellectual property contained therein.

UNLESS OTHERWISE SET FORTH IN ST'S TERMS AND CONDITIONS OF SALE ST DISCLAIMS ANY EXPRESS OR IMPLIED WARRANTY WITH RESPECT TO THE USE AND/OR SALE OF ST PRODUCTS INCLUDING WITHOUT LIMITATION IMPLIED WARRANTIES OF MERCHANTABILITY, FITNESS FOR A PARTICULAR PURPOSE (AND THEIR EQUIVALENTS UNDER THE LAWS OF ANY JURISDICTION), OR INFRINGEMENT OF ANY PATENT, COPYRIGHT OR OTHER INTELLECTUAL PROPERTY RIGHT.

ST PRODUCTS ARE NOT DESIGNED OR AUTHORIZED FOR USE IN: (A) SAFETY CRITICAL APPLICATIONS SUCH AS LIFE SUPPORTING, ACTIVE IMPLANTED DEVICES OR SYSTEMS WITH PRODUCT FUNCTIONAL SAFETY REQUIREMENTS; (B) AERONAUTIC APPLICATIONS; (C) AUTOMOTIVE APPLICATIONS OR ENVIRONMENTS, AND/OR (D) AEROSPACE APPLICATIONS OR ENVIRONMENTS. WHERE ST PRODUCTS ARE NOT DESIGNED FOR SUCH USE, THE PURCHASER SHALL USE PRODUCTS AT PURCHASER'S SOLE RISK, EVEN IF ST HAS BEEN INFORMED IN WRITING OF SUCH USAGE, UNLESS A PRODUCT IS EXPRESSLY DESIGNATED BY ST AS BEING INTENDED FOR "AUTOMOTIVE, AUTOMOTIVE SAFETY OR MEDICAL" INDUSTRY DOMAINS ACCORDING TO ST PRODUCT DESIGN SPECIFICATIONS. PRODUCTS FORMALLY ESCC, QML OR JAN QUALIFIED ARE DEEMED SUITABLE FOR USE IN AEROSPACE BY THE CORRESPONDING GOVERNMENTAL AGENCY.

Resale of ST products with provisions different from the statements and/or technical features set forth in this document shall immediately void any warranty granted by ST for the ST product or service described herein and shall not create or extend in any manner whatsoever, any liability of ST.

ST and the ST logo are trademarks or registered trademarks of ST in various countries.

Information in this document supersedes and replaces all information previously supplied.

The ST logo is a registered trademark of STMicroelectronics. All other names are the property of their respective owners.

© 2013 STMicroelectronics - All rights reserved

STMicroelectronics group of companies

Australia - Belgium - Brazil - Canada - China - Czech Republic - Finland - France - Germany - Hong Kong - India - Israel - Italy - Japan - Malaysia - Malta - Morocco - Philippines - Singapore - Spain - Sweden - Switzerland - United Kingdom - United States of America

www.st.com