

# IBS S7 300 DSC-T

## Controller Board for Siemens SIMATIC® S7-300 PLCs

Data Sheet 5770B

11/1999

### Product Description

INTERBUS Generation 4 controller board for  
SIMATIC® S7-300 PLCs

#### Features

- INTERBUS protocol (DIN E 19258)
- Complete Generation 4 functionality
  - Up to 255 remote bus devices
  - Up to 16 device levels
  - Up to 512 devices
  - Up to 4096 I/O points
  - Up to 62 PCP devices
  - Synchronous operation
- Supports the INTERBUS Inline system
- Supports INTERBUS Loop/Loop 2 devices
- IBS CMD G4 support (CMD 4.50 or higher)
- User-defined addressing
- Data preprocessing on the controller board
- Comprehensive system diagnostics
- Group shutdown
- LCD displaying operating and diagnostic data directly
- Operation with keypad on the front plate

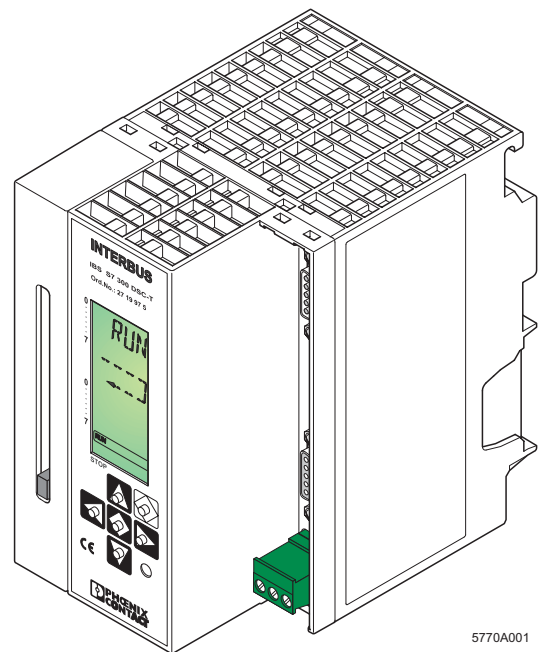

Figure 1 IBS S7 300 DSC-T

- Firmware download through RS-232
- External 24 V DC power supply

#### Applications

Coupling of INTERBUS to SIMATIC® S7-300  
PLCs.

## Module Overview

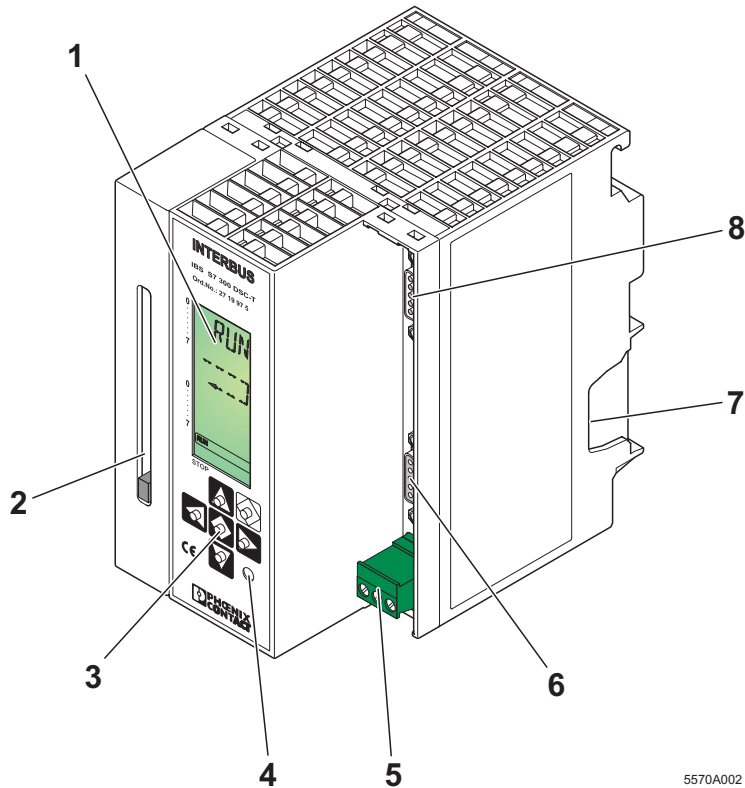

5570A002

Figure 2 Layout of the IBS S7 300 DSC-T controller board

The controller board has the following components:

- |  |   |
|--|---|
| <ul style="list-style-type: none"> <li>1 LCD</li> <li>2 Slot for the memory card (memory card not shipped together with the controller board)</li> <li>3 Operator's panel</li> <li>4 Test mode button</li> <li>5 Connection for an external power supply (24 V DC)</li> <li>6 Remote bus connection (9-pos. D-SUB female connector)</li> </ul> | <ul style="list-style-type: none"> <li>7 Location for the outgoing SIMATIC® bus connector</li> <li>8 Diagnostic interface (9-pos. D-SUB male connector) for connection to a PC</li> </ul> |
|--|---|

## Functional Units of the Controller Board

### External Power Supply

The controller board is powered through a 24 V DC supply.

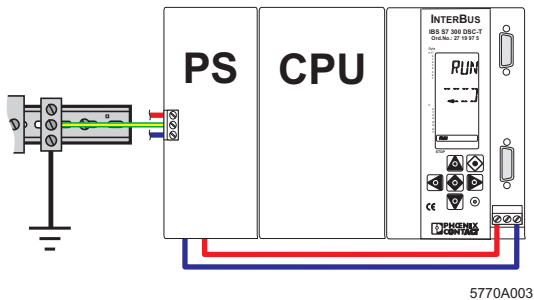
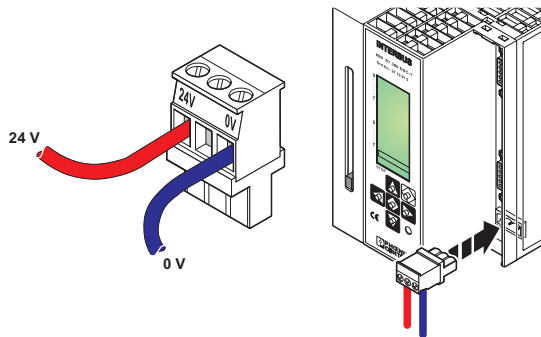

Figure 3 Connection of the external supply voltage



Note that the S7-300 system can only be operated if the external supply voltage is connected to the controller board.

### Remote Bus Connection (REMOTE)

The remote bus connection links the controller board to the INTERBUS devices (field devices). The remote bus connection on the controller board has been designed as a 9-pos. D-SUB female connector.

#### Remote bus connection

9-pos. D-SUB female connector

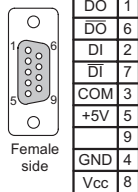

Female side

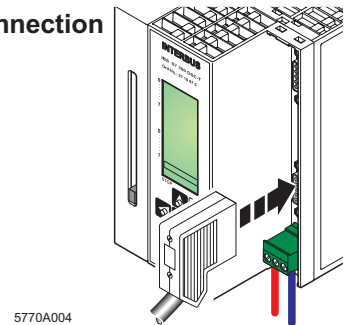

5770A004

Figure 4 Remote bus connection

Phoenix Contact offers preassembled remote bus cables in common lengths. The design is shown in the figure below.

#### Remote bus cable (D9/D9)

9-pos. D-SUB male connector

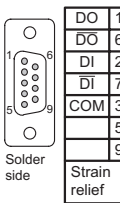

Solder side

9-pos. D-SUB female connector

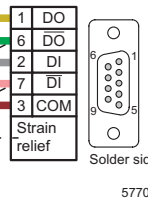

Solder side

5770A024

Figure 5 Example of a remote bus cable (cable type D9/D9)



The IBS OPTOSUB... and OPTOSUB PLUS interface connectors allow you to fit your INTERBUS system with optical fibers.

### Diagnostic Interface (RS-232)

The controller board's serial interface (RS-232) connects an IBM-compatible PC with the IBS CMD SWT G4 E software (Order No. 27 21 44 2). This software can be used to configure, parameterize, and diagnose the INTERBUS system. IBS CMD SWT G4 E is independent of the programming language and operating system of the S7-300 PLC. Parameterization and configuration information can be stored on the memory card (available as an accessory) with IBS CMD SWT G4 E. In addition, the firmware of the controller board can be downloaded. The serial interface on the front plate of the controller board has been designed as a 9-pos. D-SUB male connector.

#### Diagnostic interface

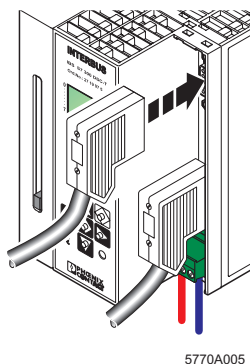
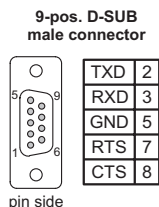

Figure 6 Diagnostic interface

The board is connected to the PC with the RS-232 cable IBS PRG CAB (Order No. 28 06 86 2) shown below.

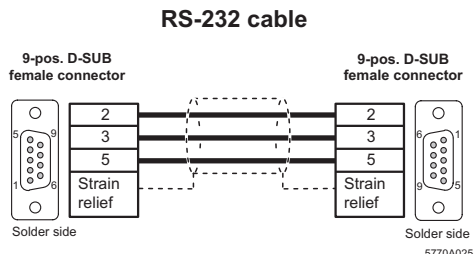
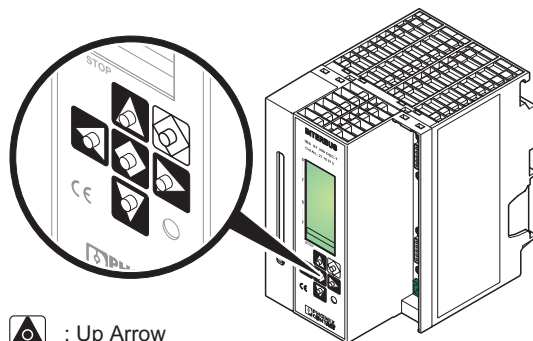







Figure 7 RS-232 cable for connection to a PC

### Keypad

The keypad consists of 6 keys and enables menu-driven operation of the controller board.



-  : Up Arrow
-  : Down Arrow
-  : Right Arrow, for selecting menu commands or addresses
-  : Left Arrow, for selecting menu commands or addresses
-  : ENTER, for confirming selection
-  : ESCAPE, for quitting menu command

5770A006

Figure 8 Keypad of the IBS S7 300 DSC-T

## LCD

The diagnostic display shows operating states, addresses, data and the type and location of any error (sometimes in plain text). 16 status segments on the left-hand side of the LCD show the binary status of the input and output words. The process image is displayed in the host-specific addressing syntax. Depending on the operating state of INTERBUS, the LCD backlighting is either green (normal operation) or red (error).

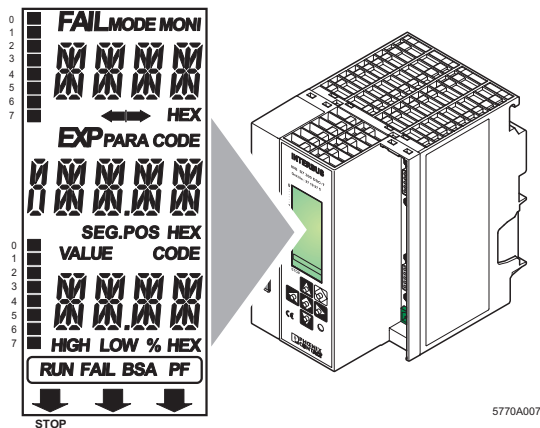

Figure 9 Diagnostic display with representation of the individual segments and lines



Please refer to the IBS SYS DIAG DSC UM E Diagnostics Guide (Order No. 27 47 29 3) for further information on the LCD and operation of the keypad.

## Slot for the Memory Card

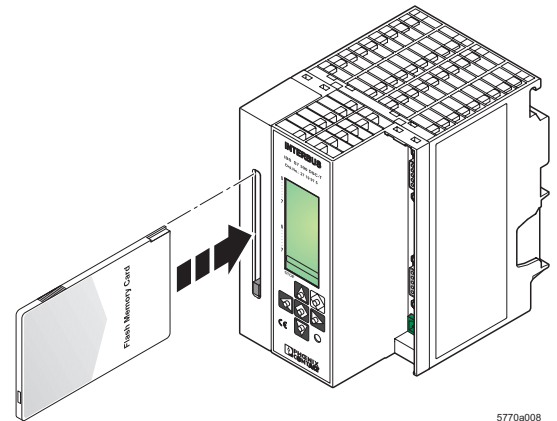

Figure 10 Inserting the memory card

A system-specific parameterization of the INTERBUS system and the controller board are stored on the plug-in memory card.

Inserting the memory card:

Insert the memory card into the slot provided, with the female connector to the front (see Figure 10). Make sure that when the memory card is pressed lightly it clicks into place and the ejector moves out.

Removing the memory card:

Press the ejector. The memory card will be ejected from the slot. You can then remove it from the front.

## Test Mode Button

This button is used for starting test mode. It is on the bottom right of the keypad on the front plate of the controller board (see Figure 2 on Page 2).

## Controller Board Installation

### Possible Slots

The S7-300 PLC is row-oriented with a maximum of four rows (0 through 3). Each row has a maximum of eight slots for I/O modules.

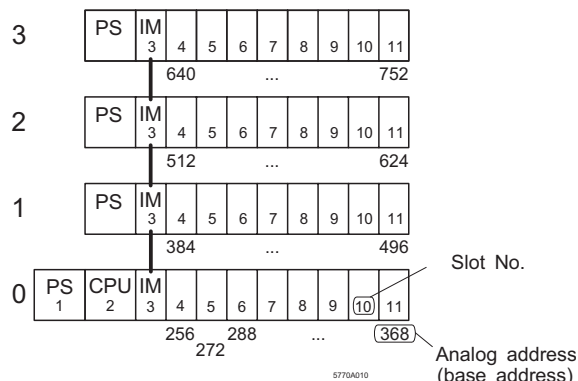

Figure 11 Structure of a SIMATIC® S7-300 PLC

### Rules for the Use of the Controller Board

The controller board can be operated in rows 0 through 3 (rows 1 through 3 for C7, SINUMERIK 810D and 840D PLCs) in slots 4 through 11. The maximum number is 2 controller boards per row.



Current consumption of the controller board:

- max. 300 mA at 24 V DC
- max. 10 mA from the S7 backplane bus

The controller board occupies one slot in the analog PLC area (16 bytes inputs and 16 bytes outputs).



Please note that the limited system resources of the S7 CPU 312 prevent the controller board from being operated in a PLC with this type of processor.

### Mounting



Switch off the PLC power supply.

Insert the bus connector in the PLC component in front of the controller board (see Figure 12).

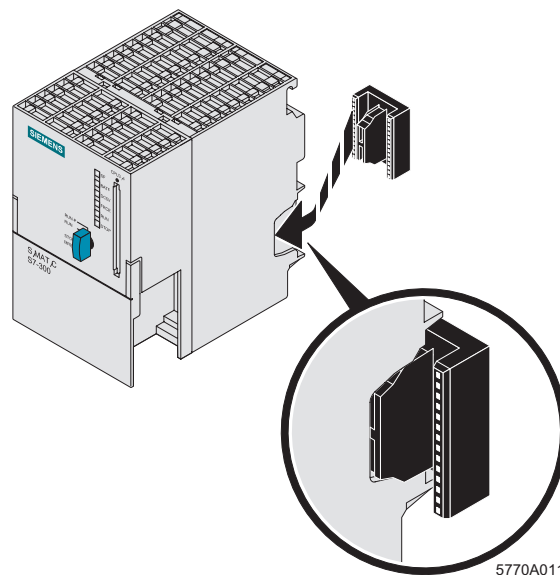

Figure 12 Inserting the bus connector

Hook the controller board onto the upper rail of the mounting channel (A) and swivel it down in the bus connector towards the mounting channel (B).

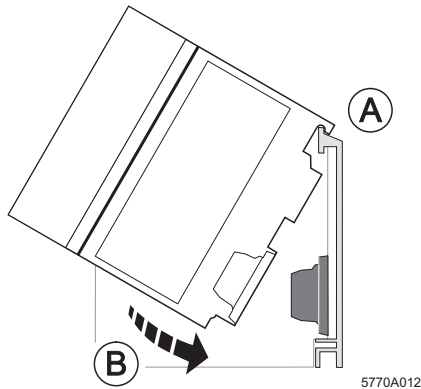

Figure 13 Installing the controller board

Lock the controller board to the mounting channel (C) using the two slotted-head screws at the bottom of the board.

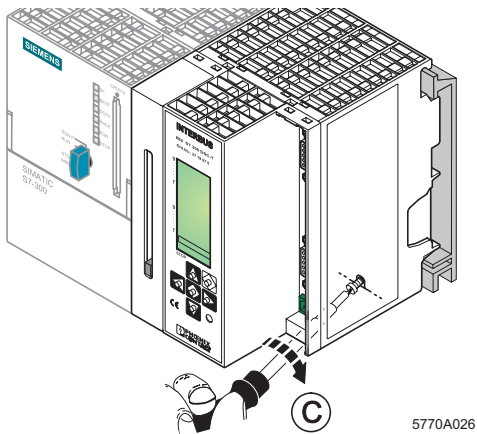

Figure 14 Locking the controller board



Make sure that the system connector makes good contact and the controller board is securely placed and locked in the PLC.

Then use the COMBICON connector to connect the controller board to the PLC power supply as described in Figure 3 on Page 3.

## Integration into STEP 7®

Integrate the controller board as a standard SIMATIC® component (FM 353 for Step Motor).

To create the hardware configuration, select one of the following two options:

- Reading out the control configuration
- Manual integration of the controller board



Please refer to the IBS S7 300 DSC QS UM E Quick Start Guide (Order No. 27 43 16 1) for further information about installing the software and integrating the controller board into STEP 7®.

## Controller Board Startup

### Test Mode

In test mode the controller board automatically reads in the data of the connected I/O devices after a board reset, checks the components connected and starts the entire system. The diagnostic display provides you with information about the system during operation. In this mode the PLC cannot set outputs.

Activate the test mode (PLC in STOP state) by keeping the test mode button depressed during the **POWER-UP** phase of the controller board. (see Figure 15).

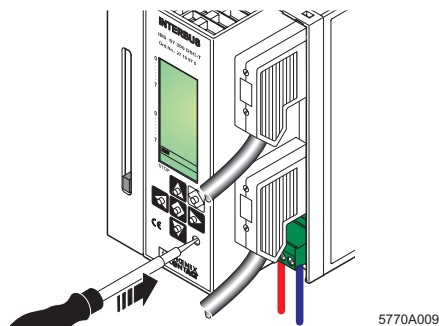

Figure 15 Test mode button

The controller board will now automatically try to start up the entire INTERBUS system. The button can be released when the "RDY" status is displayed. The display "RUN / TEST" indicates that the INTERBUS system has been installed correctly.

If an installation error prevents the system from starting normal operation, the LCD backlighting will change to red and an appropriate error message will appear.

### Linking the INTERBUS Process Data

The I/O address area of the SIMATIC® S7-300 PLC depends on the type of CPU. It is split into an input and an output address area. These contain the data of the boards operated in the PLC.

Driver blocks allow the area of the INTERBUS process data (input and output data of INTERBUS devices) to be transferred to the S7-300 PLC block by block. The driver blocks create a process image that reads the inputs prior to the application program, and writes the outputs to the controller board or output devices after they have been processed by the application program.

The driver can transfer the input/output data of the INTERBUS system into or out of the I/O area of the PLC, bit memory areas or data blocks.

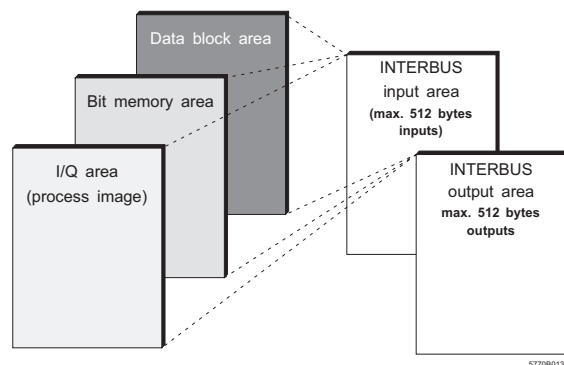

Figure 16 Source and destination areas for INTERBUS input/output data



## Linking the INTERBUS Standard Registers

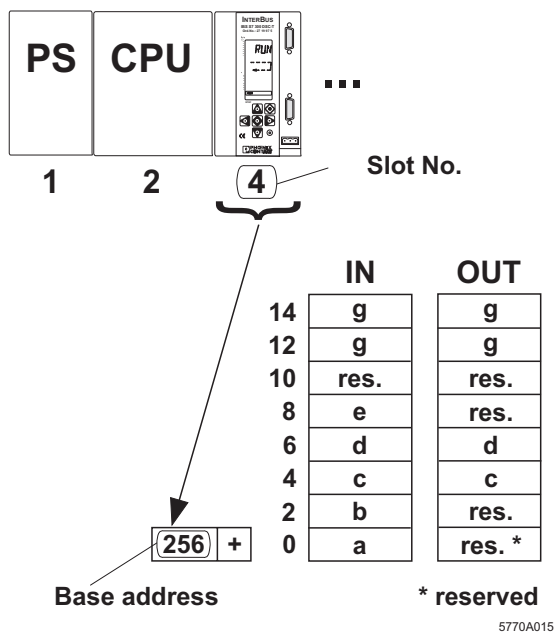

Figure 17 Location of the INTERBUS standard registers (in this case: slot 4; addresses 256 through 271)

From the base address for the controller board onwards, the INTERBUS standard registers are in the I/O address area of the S7 PLC.



In STEP 7® and IBS CMD, the base address must be set according to the slot of the board in the S7 system (see Section "Possible Slots" on page 6).

If a type of CPU that allows the base address to be changed manually in STEP 7® is being used, this address can also be set in IBS CMD.

The INTERBUS standard registers are in the address area above the base address. They allow easy control of the bus system and diagnostics. They can be addressed either directly through load or transfer instructions, or through a driver block.

- a Diagnostic status register (2 bytes)
- b Diagnostic parameter register (2 bytes)
- c Standard function start register (2 bytes)
- d Standard function parameter register (2 bytes)
- e Standard function status register (2 bytes)
- g Communication register (4 bytes)

### The Communication Register

The controller board communication register is used as an interface for the driver blocks. This register must not be overwritten.

### Controller Board Configuration

Configure the controller board using the IBS CMD SWT G4 E software version 4.50 or higher. The following are examples of settings that can be checked or changed.

- Location of the base address
- Location of the standard registers
- Data transfer parameters
- INTERBUS operating parameters



Please refer to the IBS S7 300 DSC UM E Quick Start Guide (Order No. 27 43 16 1) for further information on configuring the controller boards with IBS CMD SWT G4 E.

## Timing of MEM\_READ und MEM\_WRIT Driver Blocks

The runtimes of the FC 21 MEM\_READ and FC 22 MEM\_WRIT driver blocks depend on:

- the type of CPU used,
- the number of words (n) to be transferred
- and the area to which, or from which, they are to be copied.



The following runtime formulae apply to the transfer of data records parameterized under IBS CMD (**n** = number of words to be transferred).

**Formulae for the FC 21 MEM\_READ driver times**, classified according to destination area

CPU type	I Area	Bit Memory Area	Data Block Area
313	$t = 2330 \mu\text{s} + n * 20 \mu\text{s}$	$t = 2351 \mu\text{s} + n * 20 \mu\text{s}$	$t = 2424 \mu\text{s} + n * 20 \mu\text{s}$
314	$t = 2153 \mu\text{s} + n * 20 \mu\text{s}$	$t = 2167 \mu\text{s} + n * 20 \mu\text{s}$	$t = 2235 \mu\text{s} + n * 20 \mu\text{s}$
315/316	$t = 2008 \mu\text{s} + n * 20 \mu\text{s}$	$t = 2020 \mu\text{s} + n * 20 \mu\text{s}$	$t = 2070 \mu\text{s} + n * 20 \mu\text{s}$

**Formulae for the FC 22 MEM\_WRIT driver times**, classified according to source area

CPU Type	Q Area	Bit Memory Area	Data Block Area
313	$t = 2359 \mu\text{s} + n * 20 \mu\text{s}$	$t = 2380 \mu\text{s} + n * 20 \mu\text{s}$	$t = 2453 \mu\text{s} + n * 20 \mu\text{s}$
314	$t = 2174 \mu\text{s} + n * 20 \mu\text{s}$	$t = 2188 \mu\text{s} + n * 20 \mu\text{s}$	$t = 2256 \mu\text{s} + n * 20 \mu\text{s}$
315/316	$t = 2025 \mu\text{s} + n * 20 \mu\text{s}$	$t = 2037 \mu\text{s} + n * 20 \mu\text{s}$	$t = 2087 \mu\text{s} + n * 20 \mu\text{s}$

### Comparison of FC 21 and FC 22 Driver Times for Different Types of CPU in the Selectable Source and Destination Areas

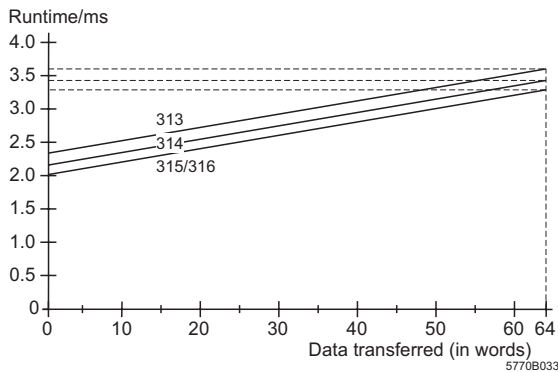

Figure 18 FC 21, I area

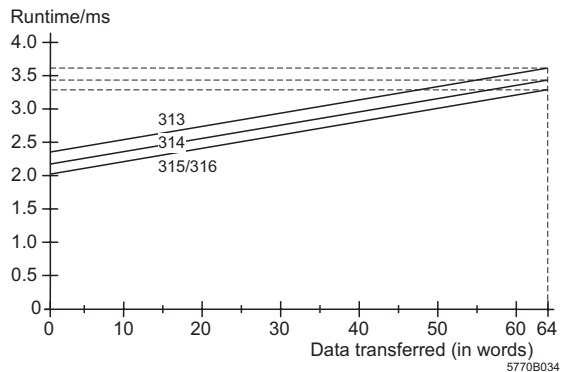

Figure 19 FC 21, bit memory area

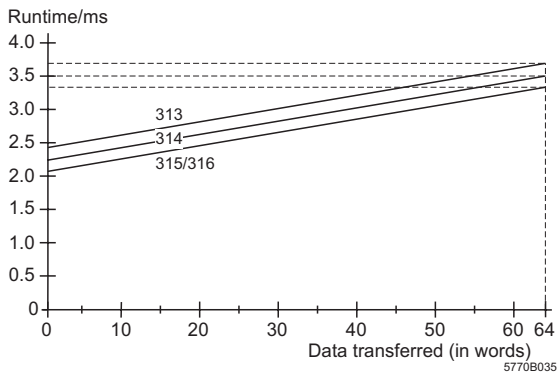

Figure 20 FC 21, data block area

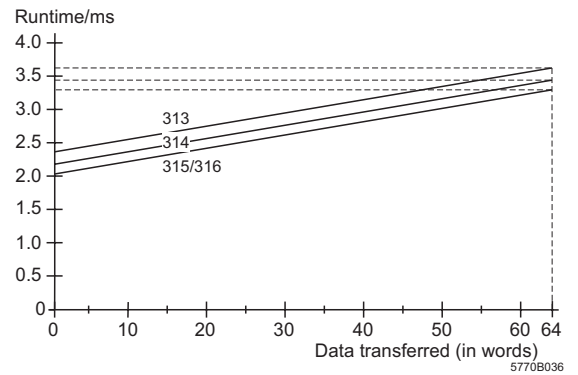

Figure 21 FC 22, Q area

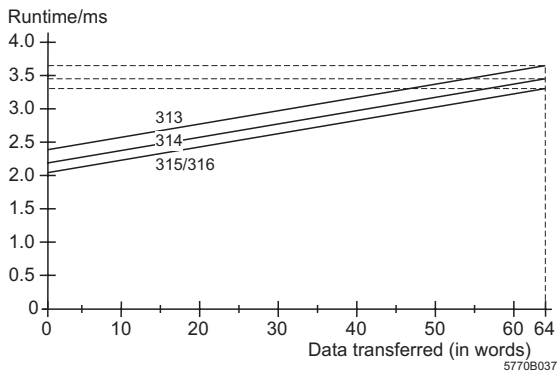

Figure 22 FC 22, bit memory area

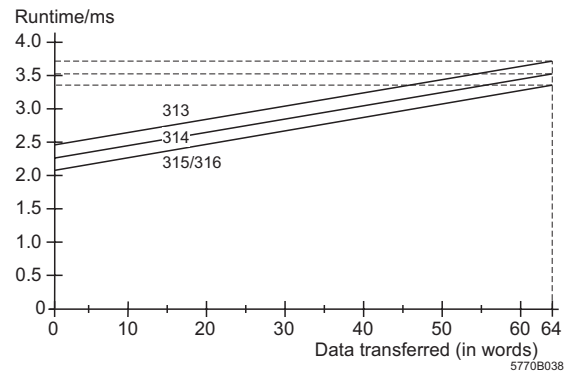

Figure 23 FC 22, data block area

## Diagnostic Registers

The diagnostic display is mapped to the PLC by the diagnostic status register and diagnostic parameter register. These registers inform the control system about the current state of the INTERBUS system. In the application program, operating states, errors, and other information are represented as inputs.

The extended diagnostic parameter register contains additional diagnostic information about the INTERBUS system (e.g., Inline).

### Diagnostic Status Register

In the diagnostic status register, information is available as input bits. A state is assigned to each bit and further defined by the diagnostic parameter register.

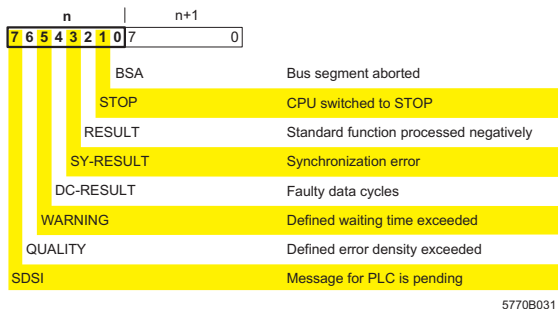
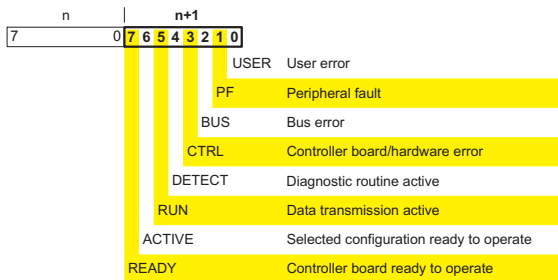

### Diagnostic Parameter Register

The diagnostic parameter register provides further information about the error that is indicated in the diagnostic status register. This is either the error location (in the case of bus errors) or

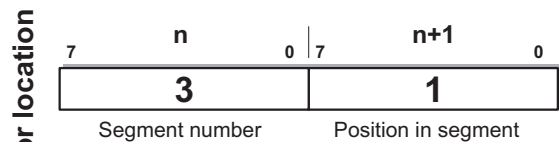

Example: Device number 3.1

5770B032

the error code.

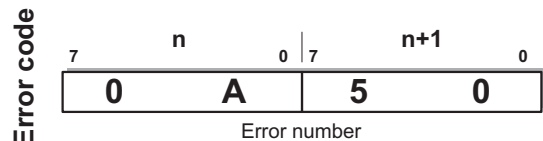

Example: Address overlap, code 0A50<sub>hex</sub>

5770A028

Whenever an error bit is set, the 16-bit diagnostic parameter register is rewritten. If no error bit is set, the register has the value 0.

### Standard Function Start Register

Frequently used predefined functions can be executed with a special standard function start register, by setting an output bit (presetting).



New functions can only be executed after the preceding function has finished.

Figure 24 Diagnostic status register

The individual standard function start bits have the following functions:

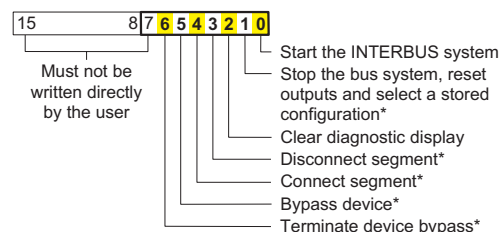

5770A030



Please refer to the IBS S7 300 DSC QS UM E (Order No. 27 43 16 1) Quick Start Guide and the IBS SYS DIAG DSC UM E Diagnostics Guide (Order No. 27 47 29 3) for further information.

Figure 25 Assignment of frequently used functions in the standard function start register



When writing bits 7 through 15 of the standard function start register directly, errors may arise in the INTERBUS system that could result in injury or damage to property.

The processing sequence can be controlled using the corresponding standard function status bit. During the processing of a function, the corresponding standard function status bit is active.

Regardless of whether or not it was possible to execute the service successfully, the standard function status bit is reset to 0 after processing.

The standard function result bit in the diagnostic status register indicates whether or not the function was completed successfully.

The functions marked with a \* need other parameters for execution. These parameters must be transferred to the separate standard function parameter register (e.g., device number).

## Technical Data

General Data	
Order designation	IBS S7 300 DSC-T
Order No.	27 19 97 5
Dimensions	80 mm x 125 mm x 110 mm (W x H x D) (3.150 in. x 4.921 in. x 4.330 in.)
Weight	500 g
Control System	
Permissible types of S7-300 CPU	313 through 316
Data Interfaces	
Control system	SIMATIC <sup>®</sup> S7-300 I/O bus
INTERBUS	Remote bus (9-pos. D-SUB female connector)
Parameterization, operation, diagnostics	RS-232-C, 9-pos. D-SUB male connector
Supply	
Connection method	Through external power supply
Voltage	Typ. 24 V DC
Permissible range	20 ... 30 V, including ripple
Ripple	3.6 mV <sub>pp</sub>
Current consumption	Max. 300 mA at 24 V DC Max. 10 mA from the S7-300 I/O bus
Insulation resistance	0.5 kV between 24 V supply voltage and 5 V logic
Ambient Conditions	
Permissible operating temperature	0 to 60°C (32 to 140°F) (horizontal mounting) 0 to 40°C (32 to 104°F) (vertical mounting)
Permissible storage temperature	-40 to 70°C (-40 to 158°F)
Permissible humidity (operation)	30 to 75% (without condensation)
Permissible humidity (storage and transport)	30 to 95% (without condensation)
Permissible air pressure (operation)	860 to 1080 hPa (up to 1500 m [4922 ft.] above sea level)
Permissible air pressure (storage and transport)	660 to 1080 hPa (up to 3,500 m [11,483 ft.] above sea level)

Programming Data	
Addressable PLC areas	Input/output (I/Q) and bit memory (M) areas, and data blocks (DB)
Occupied analog address area	16 bytes inputs and 16 bytes outputs
Interrupts	Process alarm

INTERBUS Data	
Number of devices	512 (255 remote bus devices)
Number of process data words	256 words (4096 binary inputs/outputs)
Number of PCP devices	62

Optical Diagnostics	
Operating status	Through 4-line LCD
Error status	Through 4-line LCD
I/O status	Through 4-line LCD

#### Conformance With EMC Directive 89/336/

Noise Immunity Test According to EN 50 082-2		
Electrostatic discharge (ESD)	EN 61 000-4-2/ IEC 1000-4-2	Criterion B 6 kV contact discharge 8 kV air discharge
Electromagnetic fields	ENV 50 140 IEC 1000-4-3	Criterion A Field strength: 10 V/m
Fast transients (burst)	EN 61 000-4-4/ IEC 1000-4-4	Criterion B Signal/data lines: 2 kV
Conducted interference	ENV 50 141 IEC 1000-4-6	Criterion A Test voltage 10 V
Surge test	ENV 50.142 IEC 801-5	Criterion C Signal/data lines: 2 kV Supply line: 0.5 kV
Noise emission test according to EN 55 011		
Noise emission of housing	EN 55 011	Class A, Gr. 1

#### EEC

Ordering Data

Meaning	Order designation	Order No.
S7 -300 controller board	IBS S7 300 DSC-T	27 19 97 5
S7 300 DSC system package with S7 300 controller board, user manual, RS-232 connecting cable, memory card, and IBS CMD software (German)	IBS S7 DSC SYSKIT	27 21 30 3
S7 300 DSC system package (English)	IBS S7 300 SYSKIT E	27 21 31 6
User manual including driver software (German)	IBS S7 300 DSC UM	27 21 32 9
User manual including driver software (English)	IBS S7 300 DSC UM E	27 21 33 2
Memory card (pluggable)	IBS MC FLASH	27 51 77 1
Cable for connecting controller board - to PC (RS-232), 3 m long - to PG (TTY), 0.9 m long	IBS PRG CAB PSM KA V.24/TTY-P/PA	28 06 86 2 27 62 00 3
IBS CMD software (German)	IBS CMD SWT G4	27 21 43 9
IBS CMD software (English)	IBS CMD SWT G4 E	27 21 44 2
Installation Manual for INTERBUS (German)	IBS SYS INST UM	27 54 28 6
Installation Manual for INTERBUS (English)	IBS SYS INST UM E	27 54 80 4
I/O Systems Manual for INTERBUS (German)	IBS SYS PRO UM	27 53 82 1
I/O Systems Manual for INTERBUS (English)	IBS SYS PRO UM E	27 51 00 1
Fiber-optic interface connector for REMOTE interface, polymer fiber	OPTOSUB-PLUS-K/OUT	27 99 61 0
Fiber-optic interface connector for REMOTE interface, glass fiber	OPTOSUB-PLUS-G/OUT	27 99 63 6

Phoenix Contact GmbH & Co  
 Flachsmarktstr. 8  
 32825 Blomberg  
 Germany



+ 49 - (0) 52 35 - 3-00



+ 49 - (0) 52 35 - 3-4 12 00



www.phoenixcontact.com