

Skywire™ Development Kit User Manual

NimbeLink Corp

Updated: March 2016



© NimbeLink Corp. 2016. All rights reserved.

NimbeLink Corp. provides this documentation in support of its products for the internal use of its current and prospective customers. The publication of this document does not create any other right or license in any party to use any content contained in or referred to in this document and any modification or redistribution of this document is not permitted.

While efforts are made to ensure accuracy, typographical and other errors may exist in this document. NimbeLink reserves the right to modify or discontinue its products and to modify this and any other product documentation at any time.

All NimbeLink products are sold subject to its published Terms and Conditions, subject to any separate terms agreed with its customers. No warranty of any type is extended by publication of this documentation, including, but not limited to, implied warranties of merchantability, fitness for a particular purpose and non-infringement.

XBee is a registered trademark of Digi International, Inc

NimbeLink is a registered trademark, and Skywire is a trademark, of NimbeLink Corp. All trademarks, service marks and similar designations referenced in this document are the property of their respective owners.

1. Introduction

- 1.1 Orderable Part Numbers
- 1.2 Product Overview
- 1.3 Block Diagram

2. Connect to Kit using a PC

- 2.1 Unpack Kit Contents
- 2.2 Skywire™ Placement
- 2.3 Attach Antenna to Baseboard
- 2.4 Ensure header J6 is shorted with 2 pin Jumper
- 2.5 Plug in 12V Power Supply to connector J15
- 2.6 Plug USB cable into connector J14 and PC
- 2.7 Press and hold button S1 to power on the modem
- 2.8 Open Tera Term or similar terminal emulator
- 2.9 Test Serial Communication
- 2.10 Test Signal Strength
- 2.11 Activate Modem (one-time step)
- 2.12 SIM Card Detection (GSM Only)
- 2.13 Send Modem Activation String (1xRTT and EVDO only)
- 2.14 Setup PDP Context (GSM and LTE Only)
 - 2.14.1 For GSM Modems
 - 2.14.2 For the Verizon CAT3 LTE Skywire™
 - 2.14.3 For the Verizon CAT1 LTE Skywire™
- 2.15 Test Network Communication

3. Common Next Steps

1. Introduction

1.1 Orderable Part Numbers

Orderable Device	Description	Carrier	Network Type
NL-SWDK	Skywire Development Kit	Any	Any
NL-SW-1xRTT-A	2G 1xRTT	Aeris	CDMA
NL-SW-1xRTT-S	2G 1xRTT	Sprint	CDMA
NL-SW-1xRTT-V	2G 1xRTT	Verizon	CDMA
NL-SW-GPRS	2G GPRS	Any GSM (AT&T, T-Mobile, etc.)	GSM
NL-SW-EVDO-A	3G EVDO, GPS, GLONASS	Aeris	CDMA
NL-SW-EVDO-V	3G EVDO, GPS, GLONASS	Verizon	CDMA
NL-SW-HSPA	3G HSPA+, GPS, GLONASS, GLOBAL BANDS	Any GSM (AT&T, T-Mobile, etc.)	GSM
NL-SW-HSPAP	3G HSPA+	Any GSM (AT&T, T-Mobile, etc.)	GSM
NL-SW-HSPAPE	3G HSPA+, European Version	Any EU GSM	GSM
NL-SW-HSPAPG	3G HSPA+, GPS, GLONASS	Any GSM (AT&T, T-Mobile, etc.)	GSM
NL-SW-LTE-TSVG	LTE without Fallback, GPS, GLONASS	Verizon	CDMA
NL-SW-LTE-TNAG	LTE with HSPA+ Fallback, GPS, GLONASS	Any GSM (AT&T, T-Mobile, etc.)	GSM
NL-SW-LTE-TEUG	LTE with HSPA+ Fallback, GPS, GLONASS, EU	Any EU GSM	GSM
NL-SW-LTE-GELS3	LTE CAT1, Verizon	Verizon	CDMA

1.2 Product Overview

The Skywire™ Development Kit includes one baseboard, antenna, power supply, SIM cards, and debug cables. Skywire modems must be purchased separately. The kit enables you to develop your application directly on the Skywire™ modem with three different ways to connect:

- Connect your PC to the xE910 modem UART port via onboard USB-to-UART converter and send AT commands directly to the modem through PC terminal applications. You can also connect over USB for access to multiple COM ports.
- The kit is an Arduino shield, so you can plug the kit directly onto an Arduino microcontroller. Please see Section 3: Common Next Steps for links to example documentation.

- To connect the kit to a different processor or development kit, a 14-pin header breaks out the necessary signals for easy connection to any device. The modem supports I/O levels from 1.65-5.5V, simplifying connection to other systems.

1.3 Block Diagram

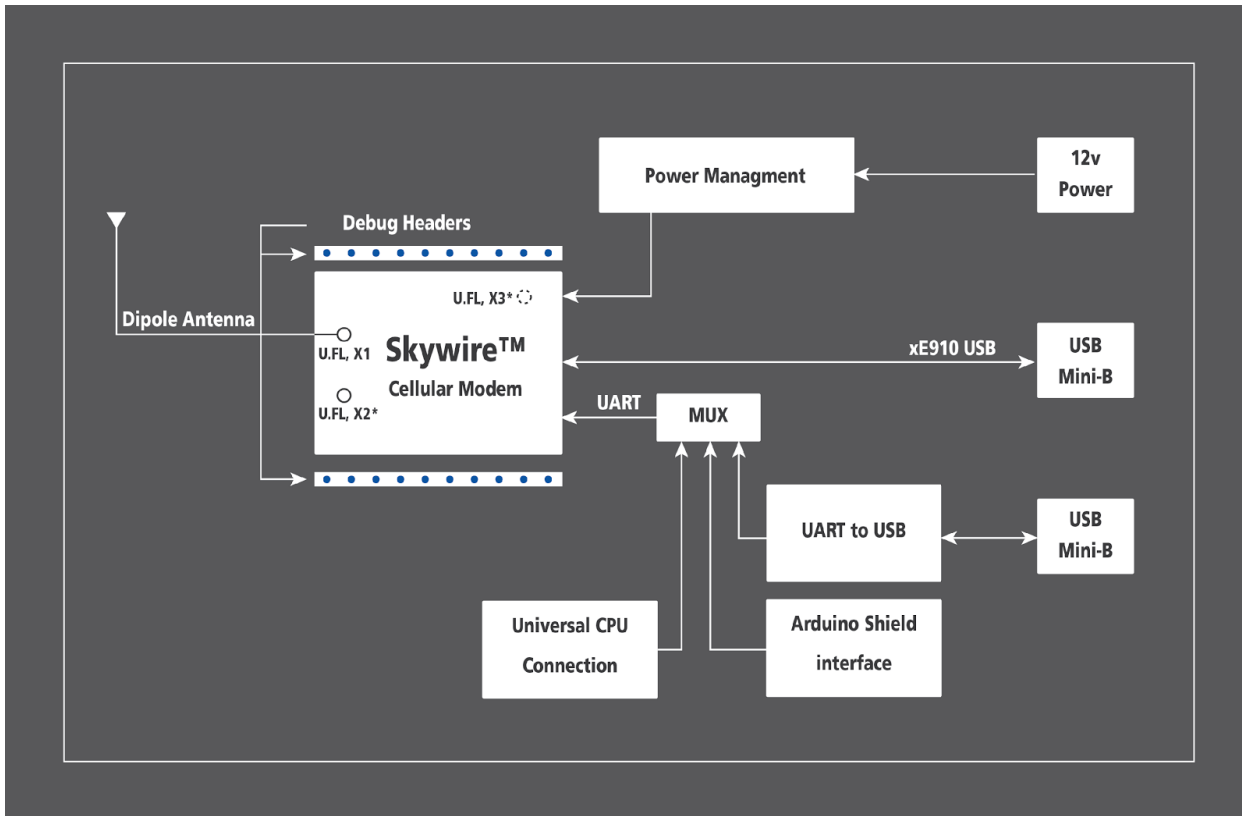

*X2 and X3 U.F.L. connectors not present on all modems.

2. Connect to Kit using a PC

This section covers how to connect your development kit to a PC and provision the modem with your cellular plan. It also covers how to communicate over the serial port to the Telit x910 modem which only requires the use of USB port and connector marked J14 or USB2 in the diagram below. USB1 (connector J5) is used for Telit firmware updates to the modem and is not used in this section.

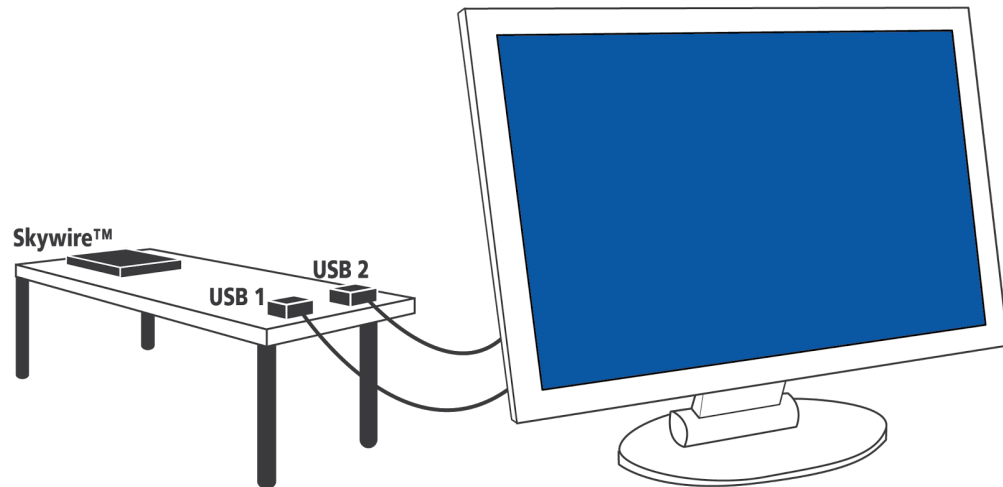

2.1 Unpack Kit Contents



2.2 Skywire™ Placement

To mount your Skywire™ Cellular modem follow these steps:

1. Gather the following:
 - a. Skywire™ Development Kit board
 - b. Skywire™ Cellular Modem
 - c. U.FL extractor tool (Always use a U.FL extractor tool when placing or removing U.FL cables on the Skywire™ modem to avoid damaging the U.FL connectors).
2. Line up your Skywire's™ cellular U.FL connector(s) on the side of the board closest to the antenna connector. Depending on the type of Skywire™ Modem you have there may be one, two, or three U.FL connections.
3. To avoid damage to the U.FL connector and maximize connector life, a U.FL removal tool should be used when attaching/removing the U.FL connector. Always insert and remove the U.FL connector with a force perpendicular to the board. If your Skywire™ is using GPS, attach the GPS antenna to the bottom of the Skywire™ connector X3. If you are not using your Skywire's™ GPS or if your Skywire™ does not support GPS, continue to step 4.
4. Attach the U.FL cable to the top U.FL connector X1 on the Skywire™. If you are using a Skywire™ with the cellular diversity antenna option attach a second antenna to connector X2.
5. Carefully seat your Skywire™ into the board's Skywire™ socket (U1). Take care to ensure that the pins are correctly aligned. Failure to properly align the pins may damage your Skywire™.

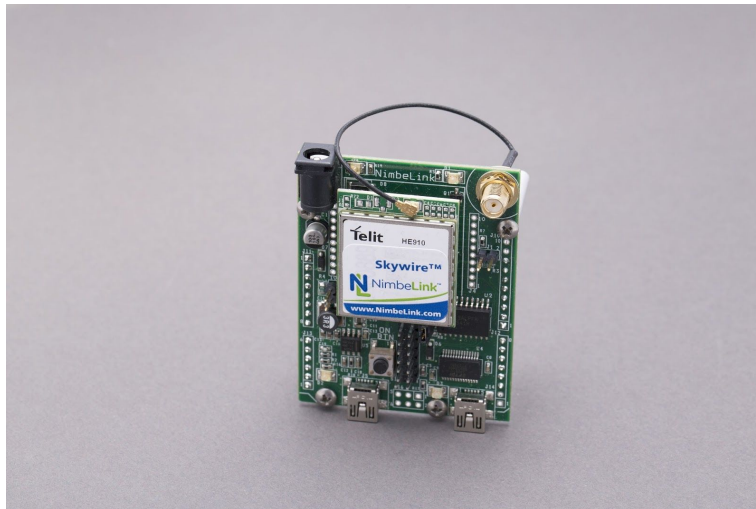

A properly mounted Skywire™ Modem with U.FL cable attached to top U.FL connector X1



A common issue is accidentally inserting the modem with pins misaligned by one row. Check pin alignment BEFORE applying power to prevent modem damage.

2.3 Attach Antenna to Baseboard

Antenna screws onto SMA connector with a clockwise rotation

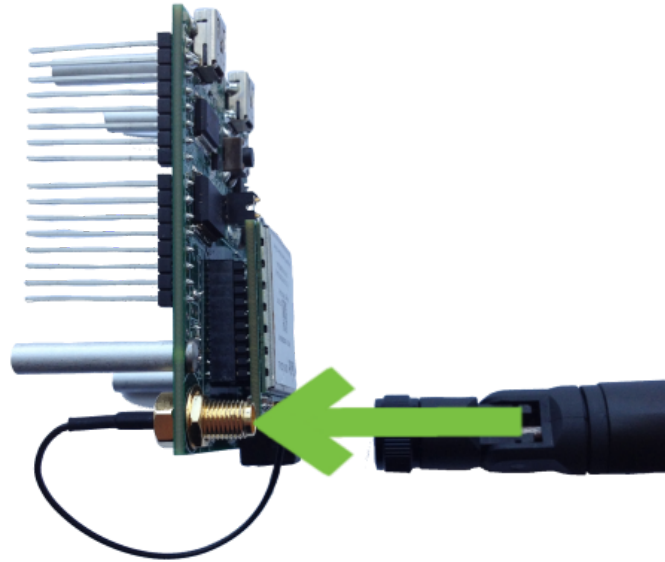

2.4 Ensure header J6 is shorted with 2 pin Jumper

This enables USB to UART communication between the PC and the modem.



2.5 Plug in 12V Power Supply to connector J15

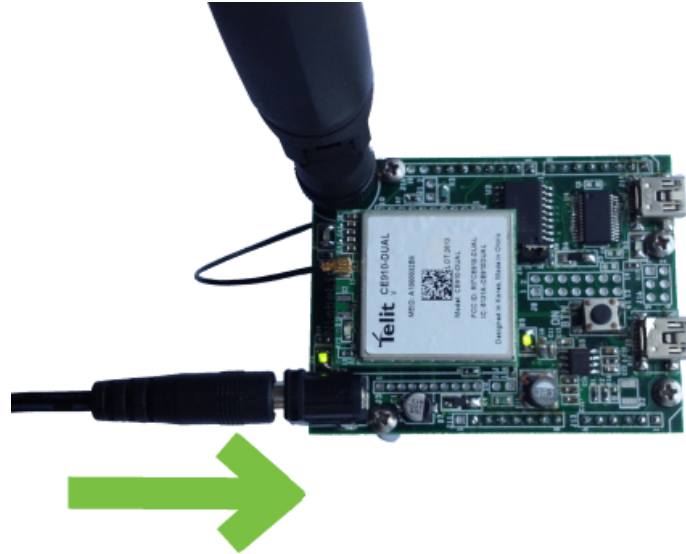

2.6 Plug USB cable into connector J14 and PC

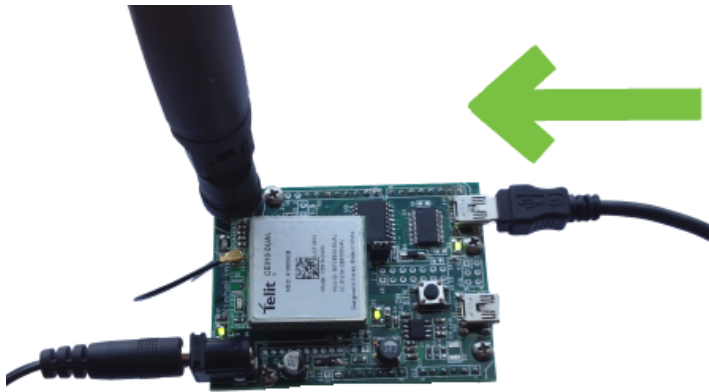

2.7 Press and hold button S1 to power on the modem

Please see the table below for the length of time needed to hold down button S1 for your particular modem.



Device	Hold Time (t_h) for Button S1 To Reset the Modem	Wait Time (t_w) Before Software Communication*	LED D1 Activity
NL-SW-1xRTT-A	1 second < t_h < 2 seconds	$t_w > 10$ seconds	Blink once
NL-SW-1xRTT-S	1 second < t_h < 2 seconds	$t_w > 10$ seconds	Blink once
NL-SW-1xRTT-V	1 second < t_h < 2 seconds	$t_w > 10$ seconds	Blink once
NL-SW-GPRS	$t_h > 5$ seconds	$t_w > 10$ second	Blink once
NL-SW-EVDO-A	1 second < t_h < 2 seconds	$t_w > 10$ seconds	Blink twice
NL-SW-EVDO-V	1 second < t_h < 2 seconds	$t_w > 10$ seconds	Blink twice
NL-SW-HSPA	$t_h > 5$ seconds	$t_w > 10$ seconds	Solid on
NL-SW-HSPAP	$t_h > 5$ seconds	$t_w > 10$ seconds	Solid on
NL-SW-HSPAPE	$t_h > 5$ seconds	$t_w > 10$ seconds	Solid on
NL-SW-HSPAPG	$t_h > 5$ seconds	$t_w > 10$ seconds	Solid on
NL-SW-LTE-TSVG	1 second < t_h < 2 seconds	$t_w > 15$ seconds	No activity
NL-SW-LTE-TNAG	1 second < t_h < 2 seconds	$t_w > 15$ seconds	No activity
NL-SW-LTE-TEUG	1 second < t_h < 2 seconds	$t_w > 15$ seconds	No activity
NL-SW-LTE-GELS3	1 second < t_h < 2 seconds	$t_w > 30$ seconds	Solid on

*Note: Depending on your modem and depending on the setup, the modem may be available for use before t_w .

2.8 Open Tera Term or similar terminal emulator

If you do not have a terminal emulator program, you can get Tera Term here: <http://logmett.com/index.php?/download/tera-term-486-freeware.html>

Your PC may have multiple COM ports. Select appropriate USB COM port to communicate with the development kit.

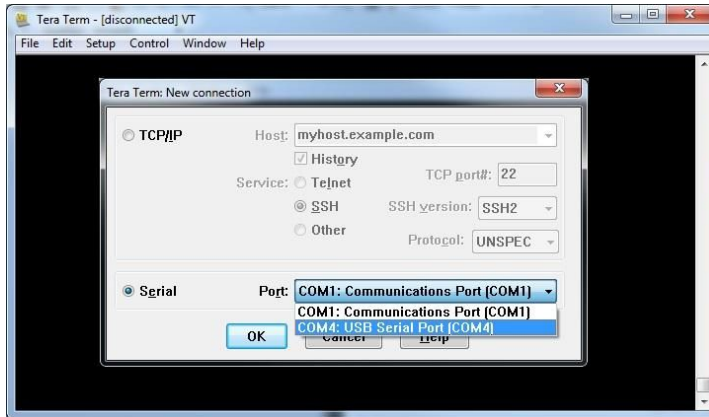

Serial Settings should be as follows (these are the default settings):

Baud Rate:	115,200 bps
Data:	8bit
Parity:	none
Stop:	1bit
Flow Control:	none

2.9 Test Serial Communication

In the terminal program, type the command:

AT

followed by the Enter key, and the terminal should respond with:

OK

Note: For the NL-SW-LTE-GELS3, you may need to turn echo on in order to see what you are typing. If you type the command:

AT

and don't see it being typed on your screen, hit the Enter key, and type the following command:

ATE1

followed by the Enter key, and the terminal program should respond with:

OK

Type the following command:

AT

to verify you can see the command you are typing. After pressing the Enter key, the terminal program will respond with:

OK

2.10 Test Signal Strength

In the terminal program, type the command:

AT+CSQ

followed by the Enter key, and the terminal should respond with:

+CSQ: xx,yy

where xx is the signal strength of the antenna, and yy is the bit error rate in percent. Typical values are as follows:

Values of xx	Relative Signal Strength
0 – 9	Marginal: -113 dBm to -95 dBm
10 – 14	OK: -93 dBm to -85 dBm
15 – 19	Good: -83 dBm to -75 dBm
20 – 30	Excellent: -73 dBm to -53 dBm
31	Excellent: -51 dBm or greater
99	Not known or not detectable

Values of yy	Bit Error Rate (in percent)
0	Less than 0.2%
1	0.2% to 0.4%
2	0.4% to 0.8%
3	0.8% to 1.6%
4	1.6% to 3.2%
5	3.2% to 6.4%
6	6.4% to 12.8%
7	More than 12.8%
99	Not known or not detectable

2.11 Activate Modem (one-time step)



If you are using a new Skywire™ cellular module, it does not have an active cellular plan. To activate a Verizon data plan, visit <http://go.nimbelink.com> and fill out the “Cellular Data Plan Activation Request Form”.

Please see below pictures for the location of the IMEI and MEID

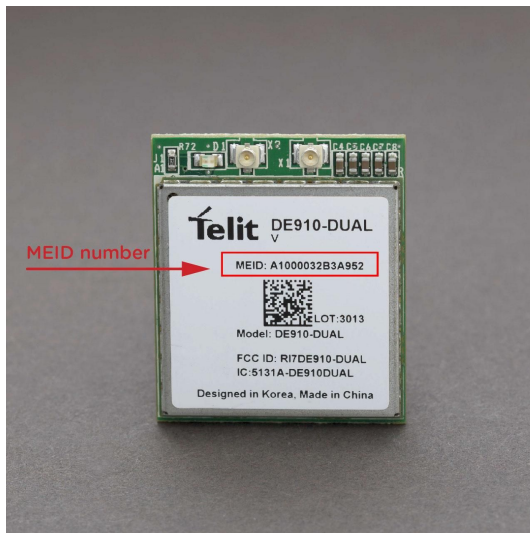

To activate the NEO SIM for GSM modems, please follow the directions printed on the AERIS SIM Card.

The NEO SIM (2FF size) must be cut to the micro-SIM (3FF) form factor in order to fit into the Skywire modems. Use the template at the following URL to cut your SIM card to size:

http://www.thechinacellphone.com/micro_sim_template.pdf

Activation of an Aeris SIM required a different process than Verizon activation. Please consult the application notes on the NimbeLink website for the activation procedure.

2.12 SIM Card Detection (GSM Only)

Applies to:

- NL-SW-GPRS
- NL-SW-HSPA
- NL-SW-HSPAP
- NL-SW-HSPAPE
- NL-SW-HSPAPG

If you are using a Skywire™ GSM modem that uses a SIM card, you need to configure the Skywire™ modem to detect it.

In the terminal program, type the command:

AT#SIMDET=1

followed by the enter key. The terminal program will respond with:

#SIMDET: 1,1

This will enable the Skywire™ SIM detection.

2.13 Send Modem Activation String (1xRTT and EVDO only)

Applies to:

- NL-SW-1xRTT-V
- NL-SW-EVDO-V

In the terminal program, type the command:

ATD*22899;

followed by the Enter key, and the module will begin the activation process which can take **several minutes**. The terminal should respond with:

OK

#OTASP: 0

#OTASP: 1

#OTASP: 2

NO CARRIER

For all other responses, review network status responses online.

2.14 Setup PDP Context (GSM and LTE Only)

Applies to:

- NL-SW-GPRS
- NL-SW-HSPA
- NL-SW-HSPAP
- NL-SW-HSPAPE
- NL-SW-HSPAPG
- NL-SW-LTE-TSVG
- NL-SW-LTE-TNAG
- NL-SW-LTE-TEUG
- NL-SW-LTE-GELS3

Before you can successfully communicate with the network using a GSM or LTE Skywire™, you need to define the PDP context.

2.14.1 For GSM modems:

In the terminal program, type the command:

AT+CGDCONT = 1,"IP","APN"

where **APN** is the individual APN for your network, followed by the Enter key, and the terminal program should respond with:

OK

To find the APN information, please contact your service provider or consult “Defining PDP Contexts and Message Service Centers”, located at the following URL:

http://nimbelink.com/wp-content/uploads/2014/10/Skywire_Defining_PDP_Contexts_MsgServ_Ctrs.pdf

To verify that the APN was set correctly, in the terminal program type the command:

AT+CGDCONT?

followed by the Enter key, and the terminal should respond with:

+CGDCONT: 1,"IP","APN"

as well as the other PDP context information on the device. To enable this setting, in the terminal program type the command:

AT#SGACT=1,1

followed by the enter key, and the terminal should respond with:

#SGACT: www.xxx.yyy.zzz

where **www.xxx.yyy.zzz** is the Skywire™ modem’s IP address.

If the **AT#SGACT** command does not work, the terminal will respond with

#ERROR

and further setup may be necessary. Check the signal strength with **AT+CSQ** to verify the Skywire™ is getting an acceptable signal. Otherwise, consult the Telit AT Command Reference Guide for your particular modem.

2.14.2 For the Verizon CAT3 LTE Skywire™ (NL-SW-LTE-TSVG):

Users have two options for setting up PDP Context on the CAT3 LTE Skywire™.

Use the VZW network to pull the proper APN:

In the terminal program, type the command:

AT#OTAUIDM=0

followed by the enter key, then wait for #DRELL response from the terminal.

Next, type the command:

AT+CGDCONT?

Read the response from the terminal and see what 3rd PDP context changed to.

The second method is to manually set the APN provided by VZW

In the terminal program, type the command:

AT#SCFG=3,3,300,90,600,50

followed by the Enter key. The terminal should respond with:

OK

This is configuration information for setting up the context in the next step.

In the terminal program, type the command:

AT+CGDCONT=3, "IP", "Verizon APN"

where **Verizon APN** is the specific APN to connect to for your intended use, followed by the Enter key, and the terminal should respond with:

OK

To get the specific APN setting that you need, please contact Verizon or contact NimbeLink.

To verify that the APN was set correctly, type the command:

AT+CGDCONT?

followed by the Enter key, and the terminal should respond with:

+CGDCONT: 3, "IP", "vzwinternet"

as well as the other PDP context information on the device.

To enable this setting, in the terminal program type the command:

AT#SGACT=3,1

followed by the enter key, and the terminal should respond with:

#SGACT: www.xxx.yyy.zzz

where **www.xxx.yyy.zzz** is the Skywire™ modem's IP address.

If the **AT#SGACT** command does not work, the terminal will respond with

#ERROR

and further setup may be necessary. Check the signal strength with **AT+CSQ** to verify the Skywire™ is getting an acceptable signal. Otherwise, consult the Telit AT Command Reference Guide for your particular modem.

2.14.3 For the Verizon CAT1 LTE Skywire™ (NL-SW-LTE-GELS3):

In the terminal program, type the command:

AT+SQNSCFG=3,3,300,90,600,50

followed by the Enter key. The terminal should respond with:

OK

This is configuration information for setting up the context in the next step.

In the terminal program, type the command:

AT+CGDCONT=3, "IP", "Verizon APN"

where **Verizon APN** is the specific APN to connect to for your intended use, followed by the Enter key, and the terminal should respond with:

OK

To get the specific APN setting that you need, please contact Verizon or contact NimbeLink.

To verify that the APN was set correctly, type the command:

AT+CGDCONT?

followed by the Enter key, and the terminal should respond with:

+CGDCONT: 3, "IP", "vzwinternet"

as well as the other PDP context information on the device.

To enable this setting, in the terminal program type the command:

AT+CGACT=1,3

followed by the enter key, and the terminal should respond with:

OK

If the **AT+CGACT** command does not work, the terminal will respond with

#ERROR

and further setup may be necessary. Check the signal strength with **AT+CSQ** to verify the Skywire™ is getting an acceptable signal. Otherwise, consult the Nimbelink AT Command Manual for NL-SW-LTE-GELS3.

2.15 Test Network Communication

The commands to test network communication differ depending on the module you have.

To test these modules:

- NL-SW-1xRTT-A
- NL-SW-1xRTT-S
- NL-SW-1xRTT-V
- NL-SW-EVDO-A
- NL-SW-EVDO-V

follow this procedure:

In the terminal program, type the command:

AT+CREG?

followed by the Enter key, and the terminal should respond with:

+CREG: 0,1 or **+CREG: 0,5**

For all other responses, review network status responses online.

To test these modules:

- NL-SW-GPRS
- NL-SW-HSPA
- NL-SW-HSPAP
- NL-SW-HSPAPE

- NL-SW-HSPAPG
- NL-SW-LTE-TSVG
- NL-SW-LTE-TNAG
- NL-SW-LTE-TEUG

follow this procedure:

In the terminal program, type the command:

AT+CGREG?

followed by the Enter key, and the terminal should respond with:

+CREG: 0,1 or **+CREG: 0,5**

For all other responses, review network status responses online.

To test NL-SW-LTE-GELS3, follow this procedure:

In the terminal program, type the command:

AT+CEREG?

followed by the Enter key, and the terminal should respond with:

+CEREG: 2, 1, xxxx, yyyyyyyy, z

For all other responses, review network status responses online.



Reset power, and repeat steps 2.5 through 2.15 (as applicable) before moving on to Section 3.

3. Common Next Steps

Once the network setup and testing is complete, you are ready to start developing with your Skywire™ modem. Common application examples include sending and receiving SMS messages, FTP file transfer, TCP/UDP packets, and using the modem with an external microcontroller, such as an Arduino. Please consult these application notes on the Skywire™ Development Kit page (<http://nimbelink.com/skywire-development-kit/>) for specific examples of each type of operation.