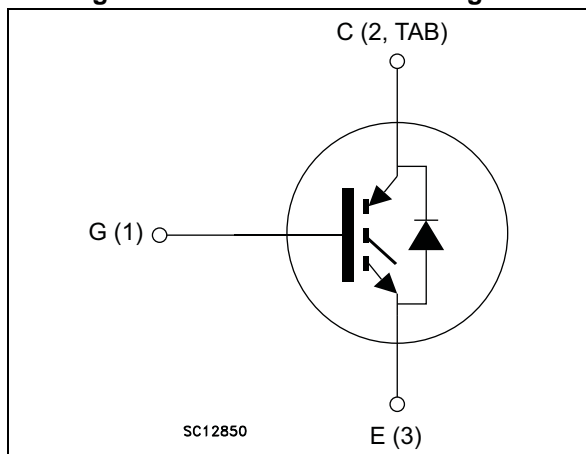

Figure 1. Internal schematic diagram



### Features

- Maximum junction temperature:  $T_J = 175\text{ °C}$
- Tail-less switching off
- $V_{CE(sat)} = 1.8\text{ V (typ.) @ } I_C = 40\text{ A}$
- Tight parameters distribution
- Safe paralleling
- Low thermal resistance
- Very fast soft recovery antiparallel diode

### Applications

- Photovoltaic inverters
- Uninterruptible power supply
- Welding
- Power factor correction
- Very high frequency converters

### Description

This device is an IGBT developed using an advanced proprietary trench gate field-stop structure. The device is part of the V series of IGBTs, which represent an optimum compromise between conduction and switching losses to maximize the efficiency of very high frequency converters. Furthermore, a positive  $V_{CE(sat)}$  temperature coefficient and very tight parameter distribution result in safer paralleling operation.

Table 1. Device summary

Order code	Marking	Package	Packaging
STGFW40V60DF	GFW40V60DF	TO-3PF	Tube
STGW40V60DF	GW40V60DF	TO-247	Tube
STGWT40V60DF	GWT40V60DF	TO-3P	Tube

## Contents

<b>1</b>	<b>Electrical ratings</b> .....	<b>3</b>
<b>2</b>	<b>Electrical characteristics</b> .....	<b>4</b>
2.1	Electrical characteristics (curves) .....	6
<b>3</b>	<b>Test circuits</b> .....	<b>13</b>
<b>4</b>	<b>Package mechanical data</b> .....	<b>14</b>
4.1	TO-3PF, STGFW40V60DF .....	14
4.2	TO-247, STGW40V60DF .....	16
4.3	TO-3P, STGWT40V60DF .....	18
<b>5</b>	<b>Revision history</b> .....	<b>20</b>

# 1 Electrical ratings

**Table 2. Absolute maximum ratings**

Symbol	Parameter	Value		Unit
		TO-247 TO-3P	TO-3PF	
$V_{CES}$	Collector-emitter voltage ( $V_{GE} = 0$ )	600		V
$I_C$	Continuous collector current at $T_C = 25\text{ °C}$	80		A
$I_C$	Continuous collector current at $T_C = 100\text{ °C}$	40		A
$I_{CP}^{(1)}$	Pulsed collector current	160		A
$V_{GE}$	Gate-emitter voltage	$\pm 20$		V
$I_F$	Continuous forward current at $T_C = 25\text{ °C}$	80		A
$I_F$	Continuous forward current at $T_C = 100\text{ °C}$	40		A
$I_{FP}^{(1)}$	Pulsed forward current	160		A
$P_{TOT}$	Total dissipation at $T_C = 25\text{ °C}$	283	62.5	W
$V_{ISO}$	Insulation withstand voltage (RMS) from all three leads to external heat sink ( $t = 1\text{ s}$ ; $T_c = 25\text{ °C}$ )		3.5	kV
$T_{STG}$	Storage temperature range	- 55 to 150		°C
$T_J$	Operating junction temperature	- 55 to 175		°C

1. Pulse width limited by maximum junction temperature

**Table 3. Thermal data**

Symbol	Parameter	Value		Unit
		TO-247 TO-3P	TO-3PF	
$R_{thJC}$	Thermal resistance junction-case IGBT	0.53	2.4	°C/W
$R_{thJC}$	Thermal resistance junction-case diode	1.14		°C/W
$R_{thJA}$	Thermal resistance junction-ambient	50		°C/W

## 2 Electrical characteristics

$T_J = 25\text{ °C}$  unless otherwise specified.

**Table 4. Static characteristics**

Symbol	Parameter	Test conditions	Min.	Typ.	Max.	Unit
$V_{(BR)CES}$	Collector-emitter breakdown voltage ( $V_{GE} = 0$ )	$I_C = 2\text{ mA}$	600			V
$V_{CE(sat)}$	Collector-emitter saturation voltage	$V_{GE} = 15\text{ V}, I_C = 40\text{ A}$		1.8	2.3	V
		$V_{GE} = 15\text{ V}, I_C = 40\text{ A}$ $T_J = 125\text{ °C}$		2.15		
		$V_{GE} = 15\text{ V}, I_C = 40\text{ A}$ $T_J = 175\text{ °C}$		2.35		
$V_F$	Forward on-voltage	$I_F = 40\text{ A}$		1.7	2.45	V
		$I_F = 40\text{ A}, T_J = 125\text{ °C}$		1.4		V
		$I_F = 40\text{ A}, T_J = 175\text{ °C}$		1.3		V
$V_{GE(th)}$	Gate threshold voltage	$V_{CE} = V_{GE}, I_C = 1\text{ mA}$	5	6	7	V
$I_{CES}$	Collector cut-off current ( $V_{GE} = 0$ )	$V_{CE} = 600\text{ V}$			25	$\mu\text{A}$
$I_{GES}$	Gate-emitter leakage current ( $V_{CE} = 0$ )	$V_{GE} = \pm 20\text{ V}$			250	nA

**Table 5. Dynamic characteristics**

Symbol	Parameter	Test conditions	Min.	Typ.	Max.	Unit
$C_{ies}$	Input capacitance	$V_{CE} = 25\text{ V}, f = 1\text{ MHz},$ $V_{GE} = 0$	-	5400	-	pF
$C_{oes}$	Output capacitance		-	220	-	pF
$C_{res}$	Reverse transfer capacitance		-	180	-	pF
$Q_g$	Total gate charge	$V_{CC} = 480\text{ V}, I_C = 40\text{ A},$ $V_{GE} = 15\text{ V},$ see <a href="#">Figure 34</a>	-	226	-	nC
$Q_{ge}$	Gate-emitter charge		-	38	-	nC
$Q_{gc}$	Gate-collector charge		-	95	-	nC

**Table 6. IGBT switching characteristics (inductive load)**

Symbol	Parameter	Test conditions	Min.	Typ.	Max.	Unit
$t_{d(on)}$	Turn-on delay time	$V_{CE} = 400\text{ V}$ , $I_C = 40\text{ A}$ , $R_G = 10\ \Omega$ , $V_{GE} = 15\text{ V}$ , see <a href="#">Figure 33</a>	-	52	-	ns
$t_r$	Current rise time		-	17	-	ns
$(di/dt)_{on}$	Turn-on current slope		-	1850	-	A/ $\mu$ s
$t_{d(off)}$	Turn-off delay time		-	208	-	ns
$t_f$	Current fall time		-	20	-	ns
$E_{on}^{(1)}$	Turn-on switching losses		-	456	-	$\mu$ J
$E_{off}^{(2)}$	Turn-off switching losses		-	411	-	$\mu$ J
$E_{ts}$	Total switching losses	-	867	-	$\mu$ J	
$t_{d(on)}$	Turn-on delay time	$V_{CE} = 400\text{ V}$ , $I_C = 40\text{ A}$ , $R_G = 10\ \Omega$ , $V_{GE} = 15\text{ V}$ , $T_J = 175\text{ }^\circ\text{C}$ , see <a href="#">Figure 33</a>	-	52	-	ns
$t_r$	Current rise time		-	21	-	ns
$(di/dt)_{on}$	Turn-on current slope		-	1538	-	A/ $\mu$ s
$t_{d(off)}$	Turn-off delay time		-	220	-	ns
$t_f$	Current fall time		-	21	-	ns
$E_{on}^{(1)}$	Turn-on switching losses		-	1330	-	$\mu$ J
$E_{off}^{(2)}$	Turn-off switching losses		-	560	-	$\mu$ J
$E_{ts}$	Total switching losses	-	1890	-	$\mu$ J	

1. Energy losses include reverse recovery of the diode.
2. Turn-off losses include also the tail of the collector current.

**Table 7. Diode switching characteristics (inductive load)**

Symbol	Parameter	Test conditions	Min.	Typ.	Max.	Unit
$t_{rr}$	Reverse recovery time	$I_F = 40\text{ A}$ , $V_R = 400\text{ V}$ , $V_{GE} = 15\text{ V}$ , $di/dt=1000\text{ A}/\mu\text{s}$ see <a href="#">Figure 33</a>	-	41	-	ns
$Q_{rr}$	Reverse recovery charge		-	440	-	nC
$I_{rrm}$	Reverse recovery current		-	21.6	-	A
$dl_{rr}/dt$	Peak rate of fall of reverse recovery current during $t_b$		-	1363	-	A/ $\mu$ s
$E_{rr}$	Reverse recovery energy		-	151	-	$\mu$ J
$t_{rr}$	Reverse recovery time	$I_F = 40\text{ A}$ , $V_R = 400\text{ V}$ , $V_{GE} = 15\text{ V}$ , $di/dt=1000\text{ A}/\mu\text{s}$ $T_J = 175\text{ }^\circ\text{C}$ , see <a href="#">Figure 33</a>	-	109	-	ns
$Q_{rr}$	Reverse recovery charge		-	2400	-	nC
$I_{rrm}$	Reverse recovery current		-	44.4	-	A
$dl_{rr}/dt$	Peak rate of fall of reverse recovery current during $t_b$		-	670	-	A/ $\mu$ s
$E_{rr}$	Reverse recovery energy		-	718	-	$\mu$ J

## 2.1 Electrical characteristics (curves)

Figure 2. Power dissipation vs. case temperature for TO-247 and TO-3P

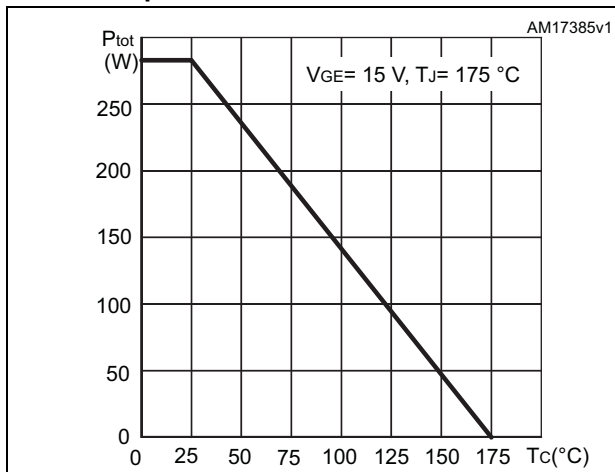

Figure 3. Collector current vs. case temperature for TO-247 and TO-3P

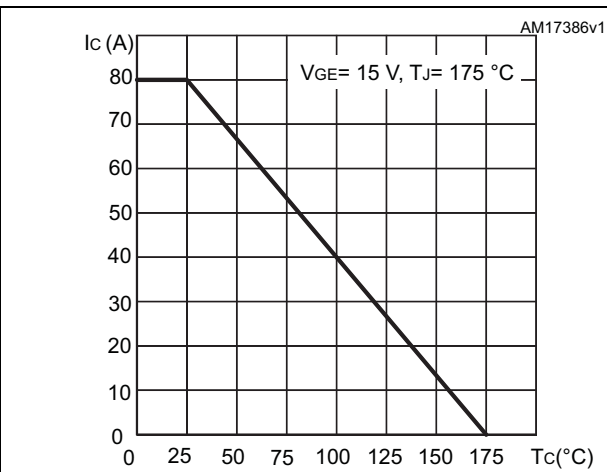

Figure 4. Power dissipation vs. case temperature for TO-3PF

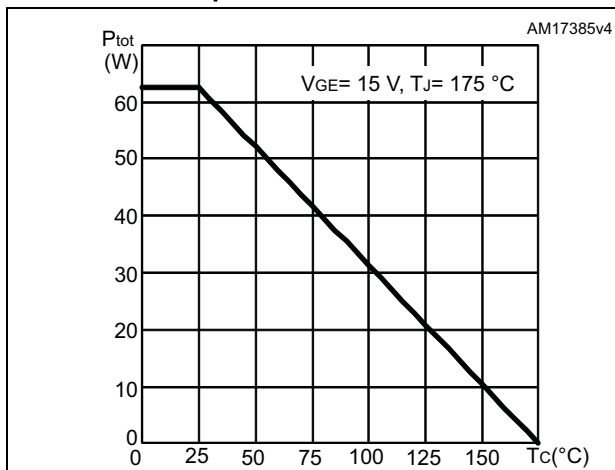

Figure 5. Collector current vs. case temperature for TO-3PF

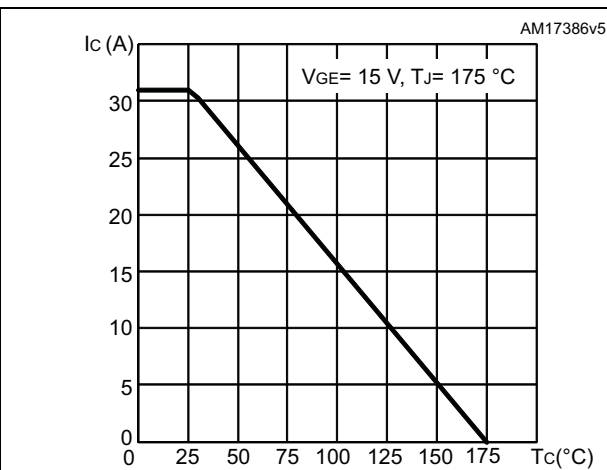

Figure 6. Output characteristics (Tj=25°C)

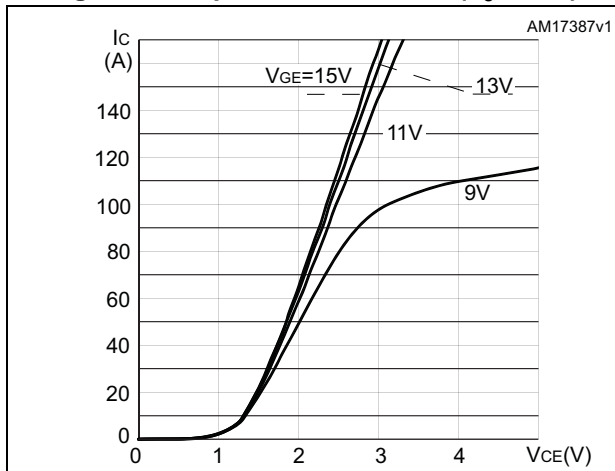

Figure 7. Output characteristics (Tj=175°C)

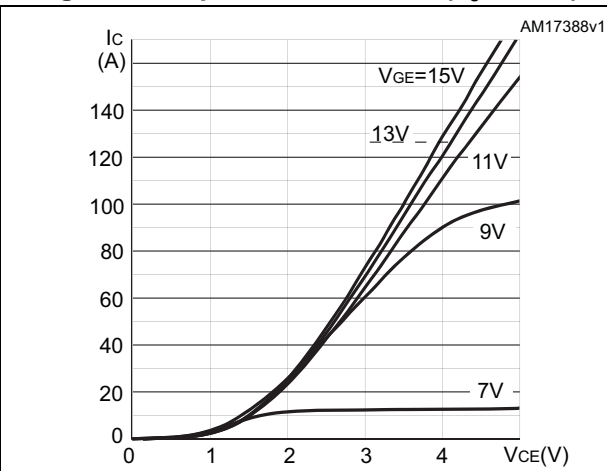

Figure 8.  $V_{CE(sat)}$  vs. junction temperature

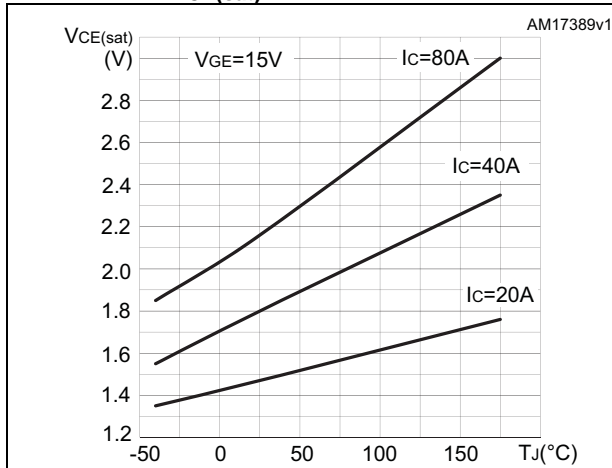

Figure 9.  $V_{CE(sat)}$  vs. collector current

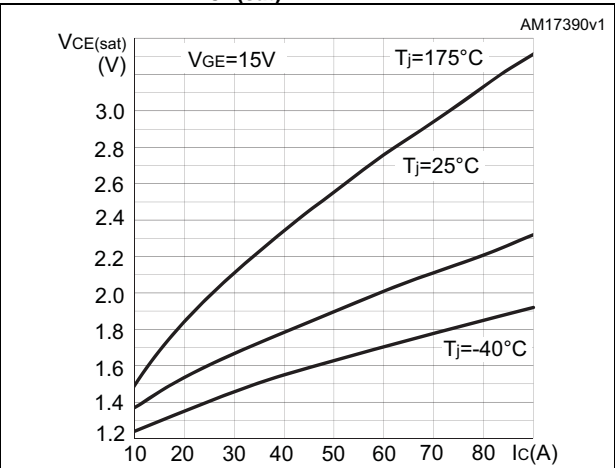

Figure 10. Collector current vs. switching frequency for TO-247 and TO-3P

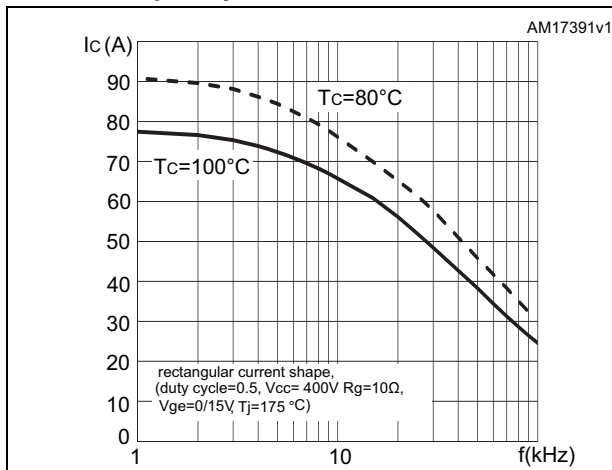

Figure 11. Collector current vs. switching frequency for TO-3PF

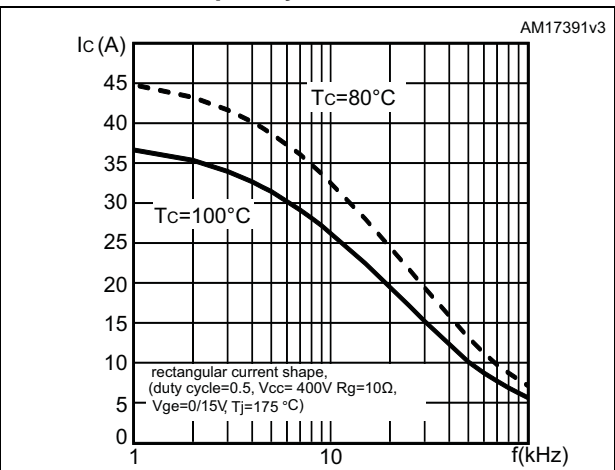

Figure 12. Forward bias safe operating area for TO-247 and TO-3P

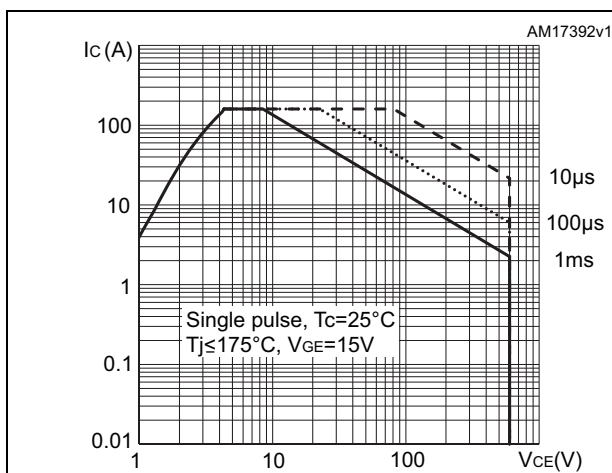

Figure 13. Forward bias safe operating area for TO-3PF

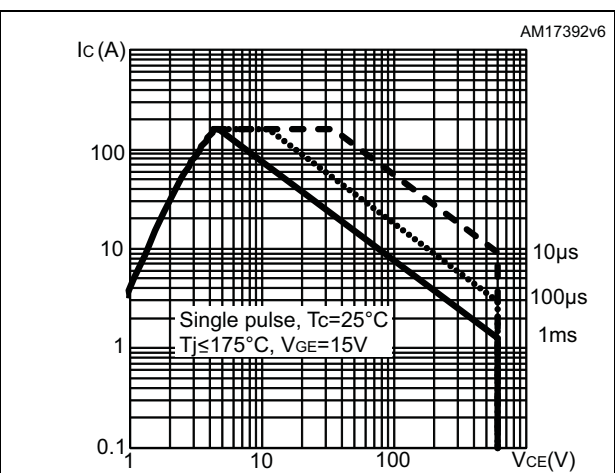

Figure 14. Transfer characteristics

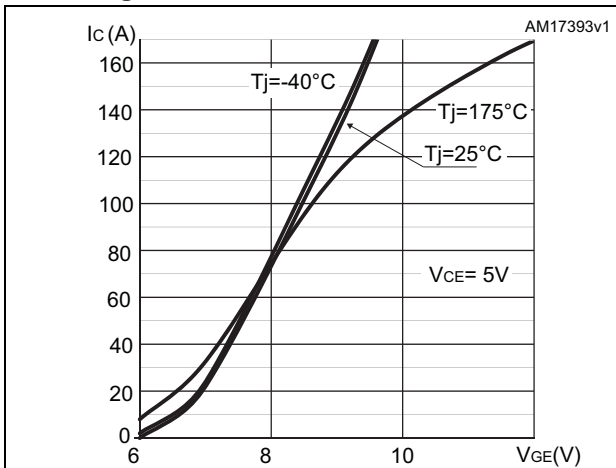

Figure 15. Diode  $V_F$  vs. forward current

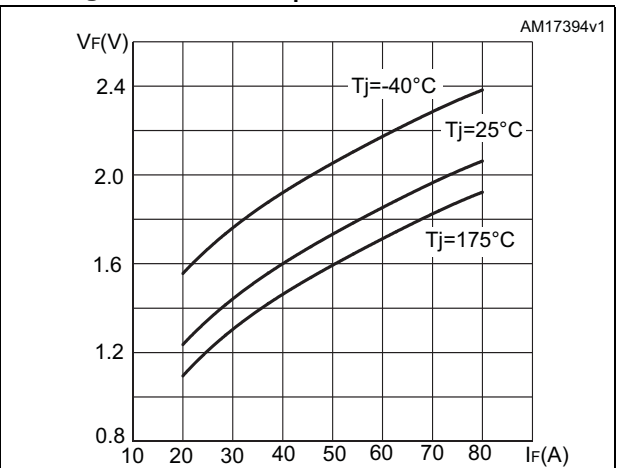

Figure 16. Normalized  $V_{GE(th)}$  vs junction temperature

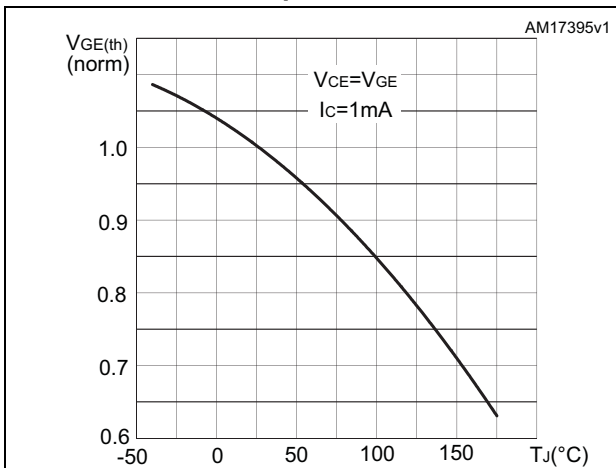

Figure 17. Normalized  $V_{(BR)CES}$  vs. junction temperature

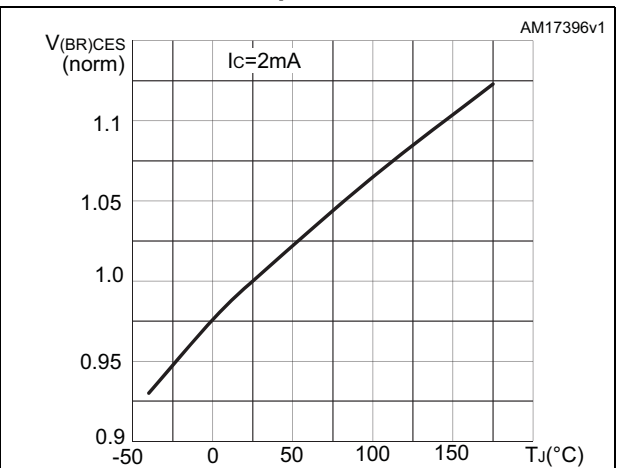

Figure 18. Capacitance variations

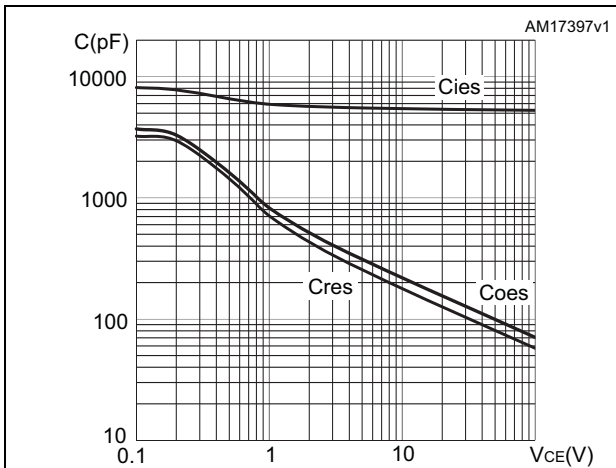

Figure 19. Gate charge vs. gate-emitter voltage

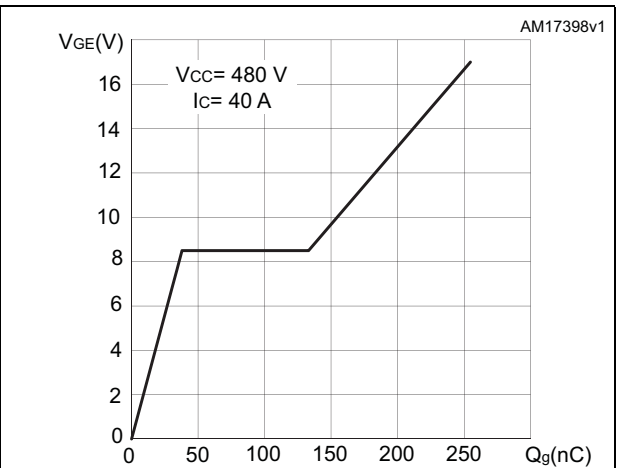



Figure 20. Switching losses vs. collector current

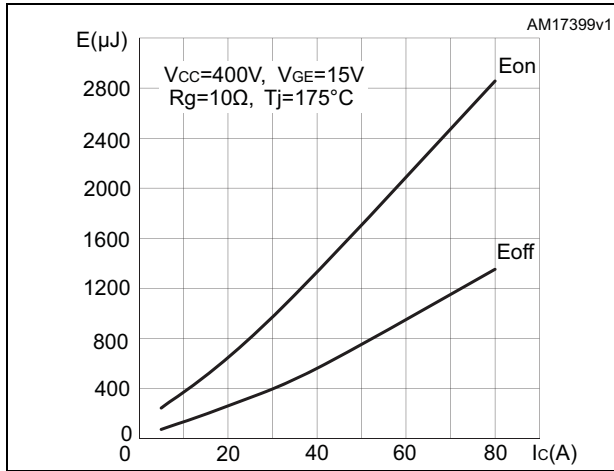

Figure 21. Switching losses vs. gate resistance

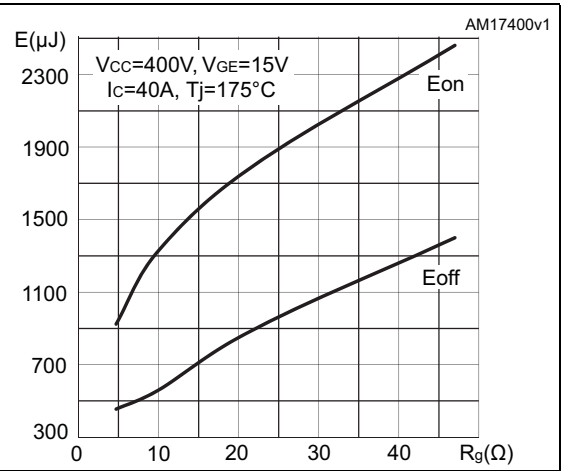

Figure 22. Switching losses vs. junction temperature

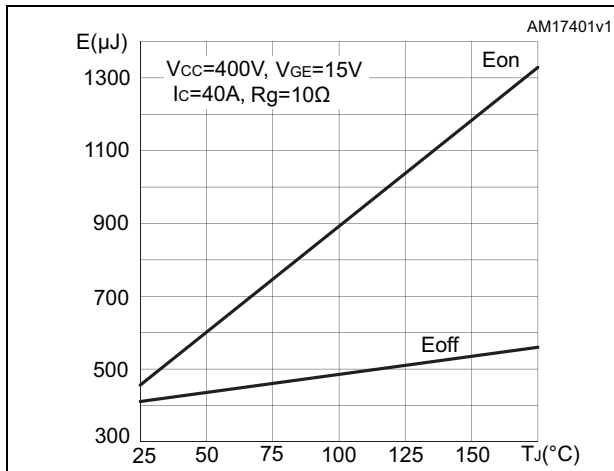

Figure 23. Switching losses vs. collector emitter voltage

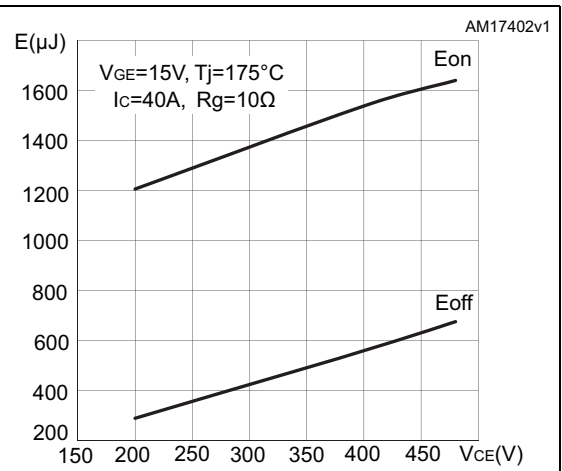

Figure 24. Switching times vs. collector current

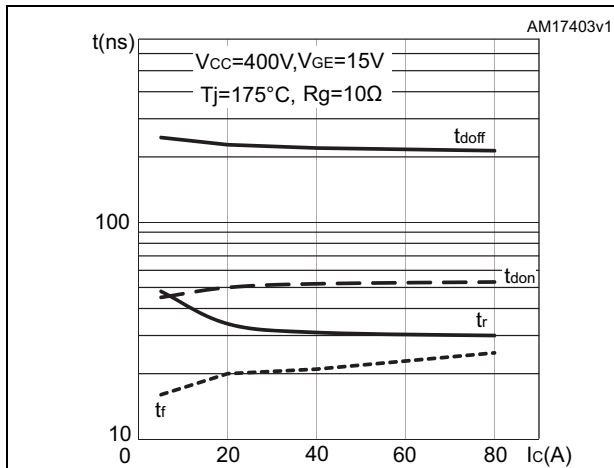

Figure 25. Switching times vs. gate resistance

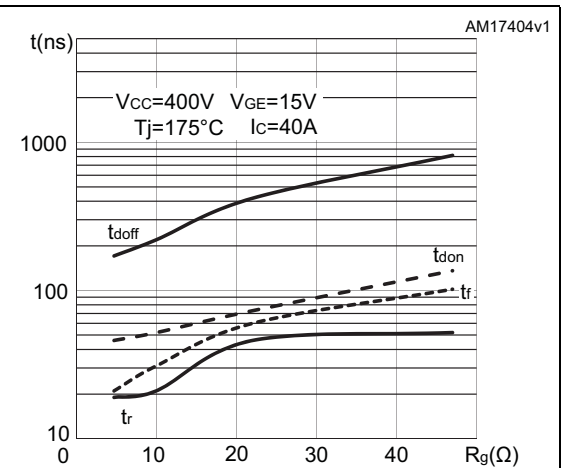

Figure 26. Reverse recovery current vs. diode current slope

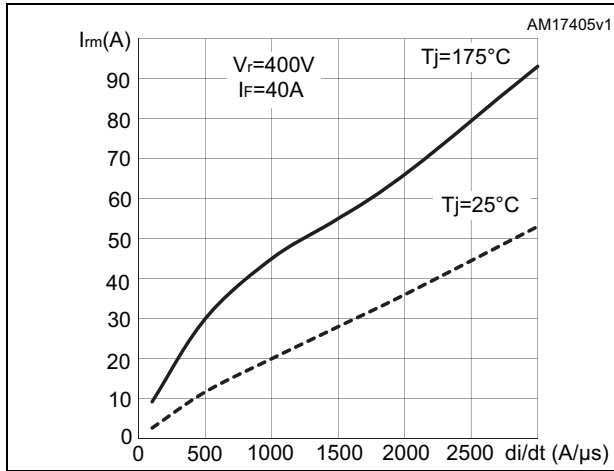

Figure 27. Reverse recovery time vs. diode current slope

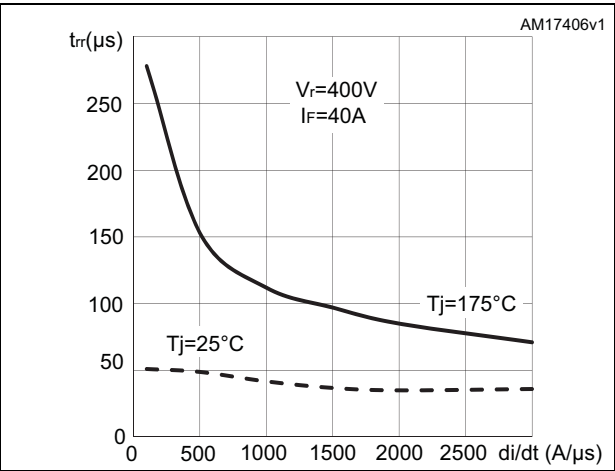

Figure 28. Reverse recovery charge vs. diode current slope

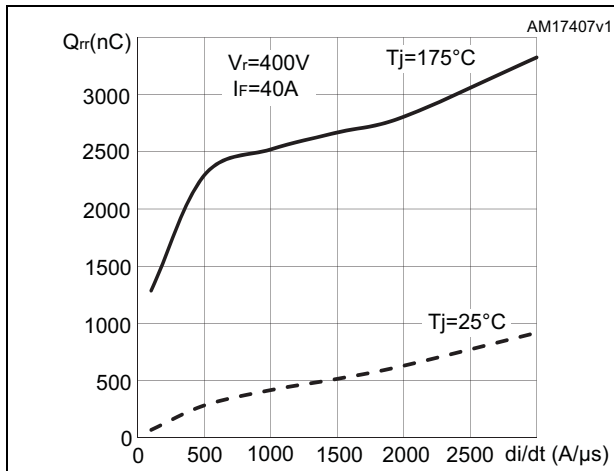

Figure 29. Reverse recovery energy vs. diode current slope

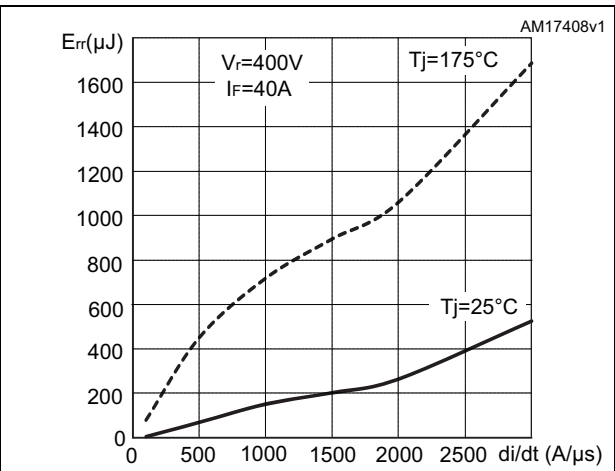

Figure 30. Thermal data for IGBT in TO-247 and TO-3P

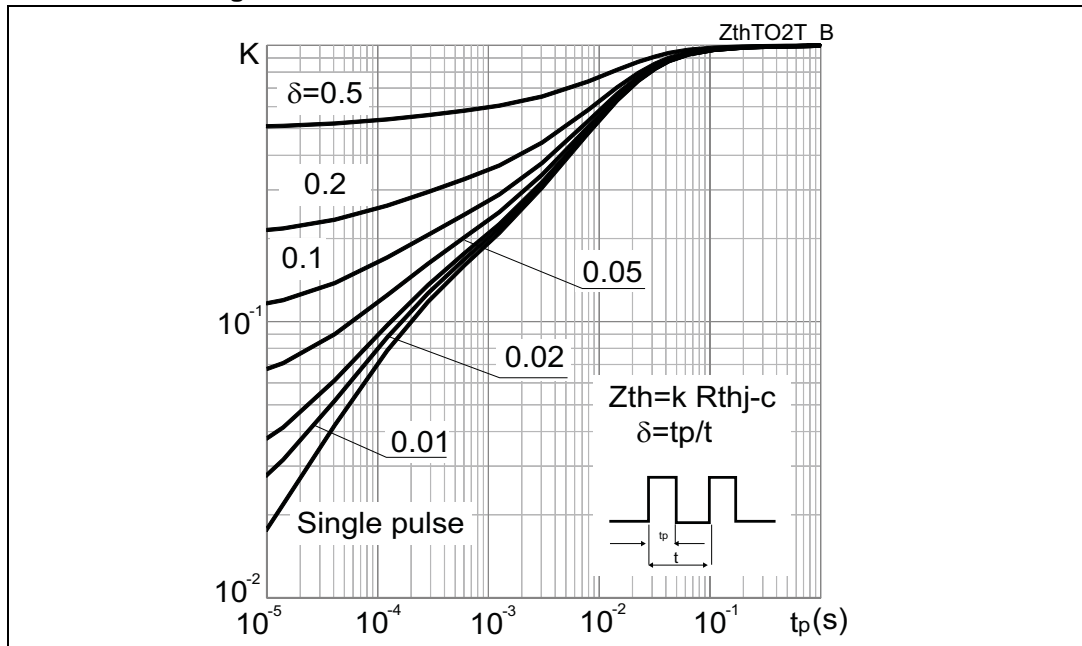

Figure 31. Thermal data for IGBT in TO-3PF

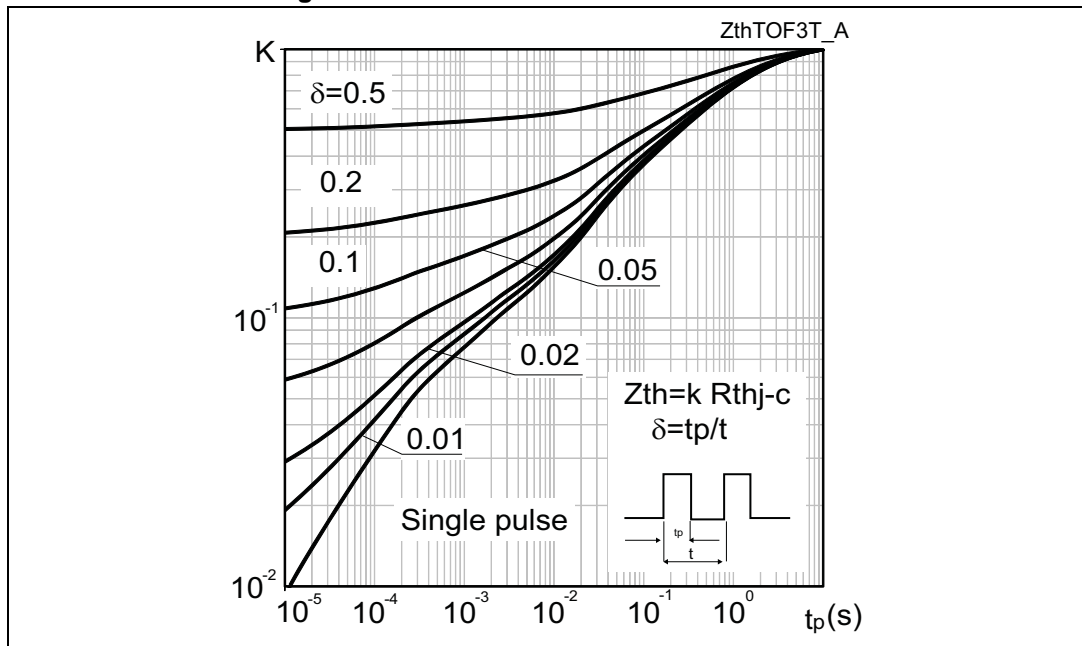
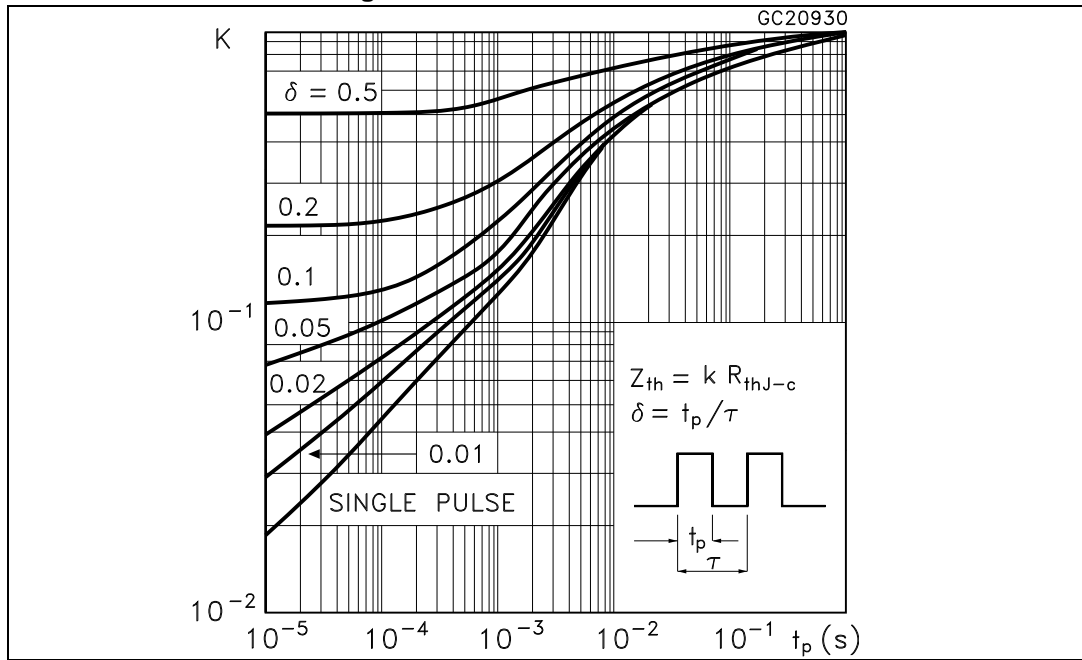
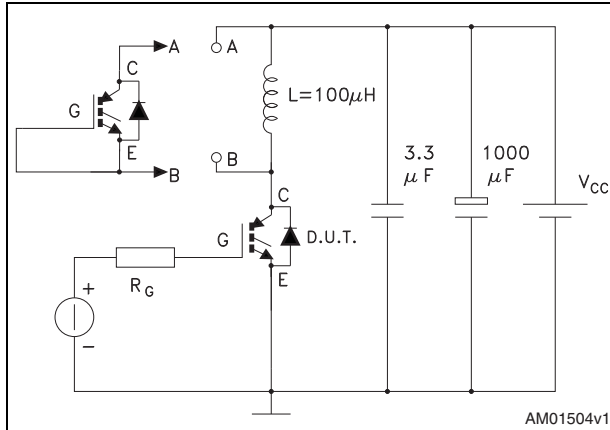

Figure 32. Thermal data for diode



### 3 Test circuits

Figure 33. Test circuit for inductive load switching



AM01504v1

Figure 34. Gate charge test circuit

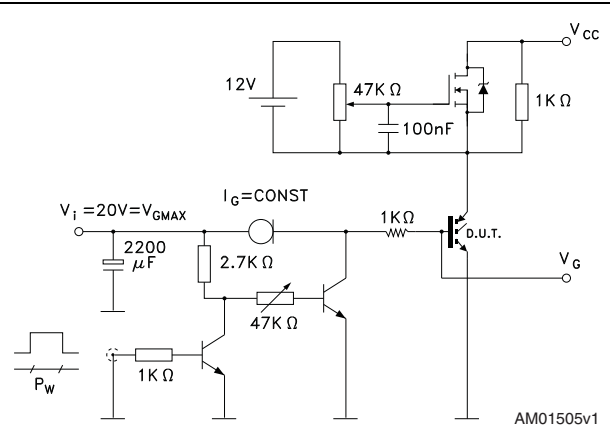

AM01505v1

Figure 35. Switching waveform

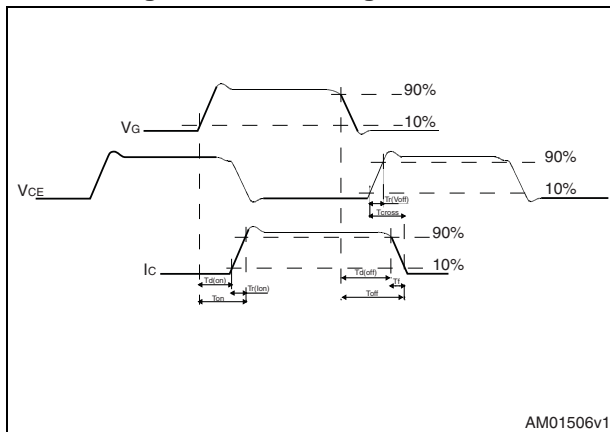

AM01506v1

Figure 36. Diode recovery time waveform

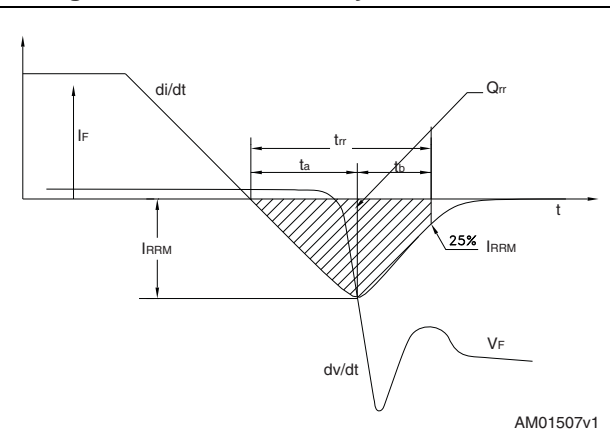

AM01507v1

## 4 Package mechanical data

In order to meet environmental requirements, ST offers these devices in different grades of ECOPACK® packages, depending on their level of environmental compliance. ECOPACK® specifications, grade definitions and product status are available at: [www.st.com](http://www.st.com). ECOPACK is an ST trademark.

### 4.1 TO-3PF, STGFW40V60DF

Figure 37. TO-3PF drawing

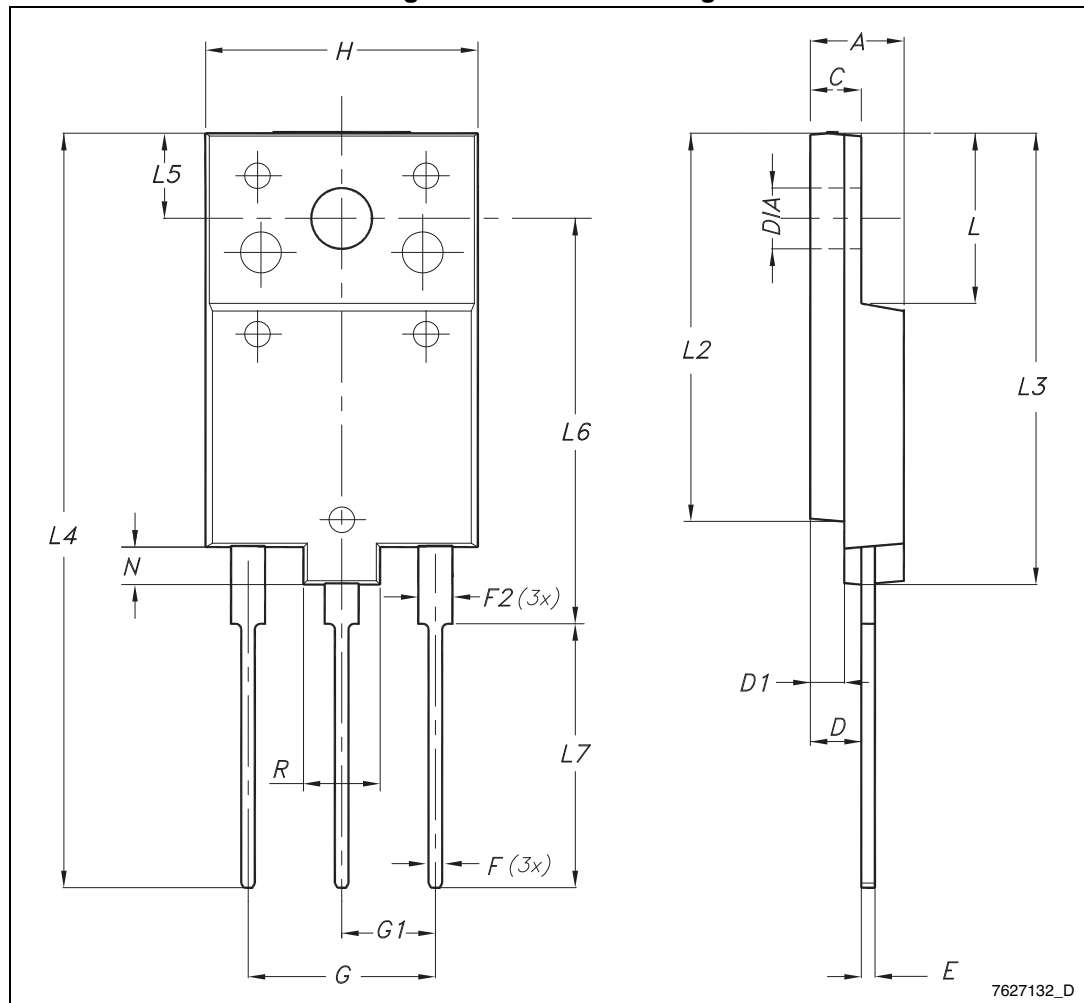

7627132\_D

Table 8. TO-3PF mechanical data

Dim.	mm		
	Min.	Typ.	Max.
A	5.30		5.70
C	2.80		3.20
D	3.10		3.50
D1	1.80		2.20
E	0.80		1.10
F	0.65		0.95
F2	1.80		2.20
G	10.30		11.50
G1		5.45	
H	15.30		15.70
L	9.80	10	10.20
L2	22.80		23.20
L3	26.30		26.70
L4	43.20		44.40
L5	4.30		4.70
L6	24.30		24.70
L7	14.60		15
N	1.80		2.20
R	3.80		4.20
Dia	3.40		3.80

4.2 TO-247, STGW40V60DF

Figure 38. TO-247 drawing

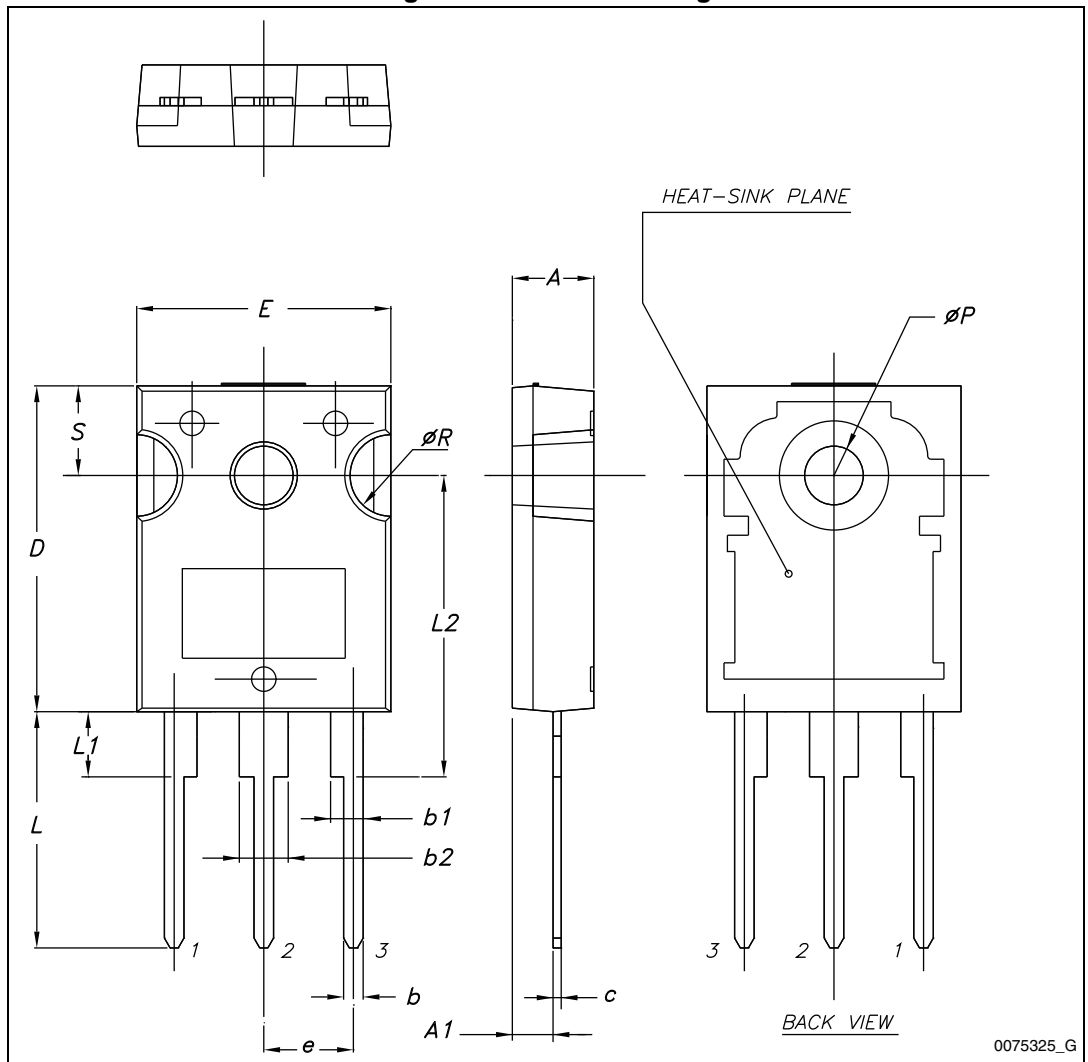



Table 9. TO-247 mechanical data

Dim.	mm.		
	Min.	Typ.	Max.
A	4.85		5.15
A1	2.20		2.60
b	1.0		1.40
b1	2.0		2.40
b2	3.0		3.40
c	0.40		0.80
D	19.85		20.15
E	15.45		15.75
e	5.30	5.45	5.60
L	14.20		14.80
L1	3.70		4.30
L2		18.50	
ØP	3.55		3.65
ØR	4.50		5.50
S	5.30	5.50	5.70

### 4.3 TO-3P, STGWT40V60DF

Figure 39. TO-3P drawing

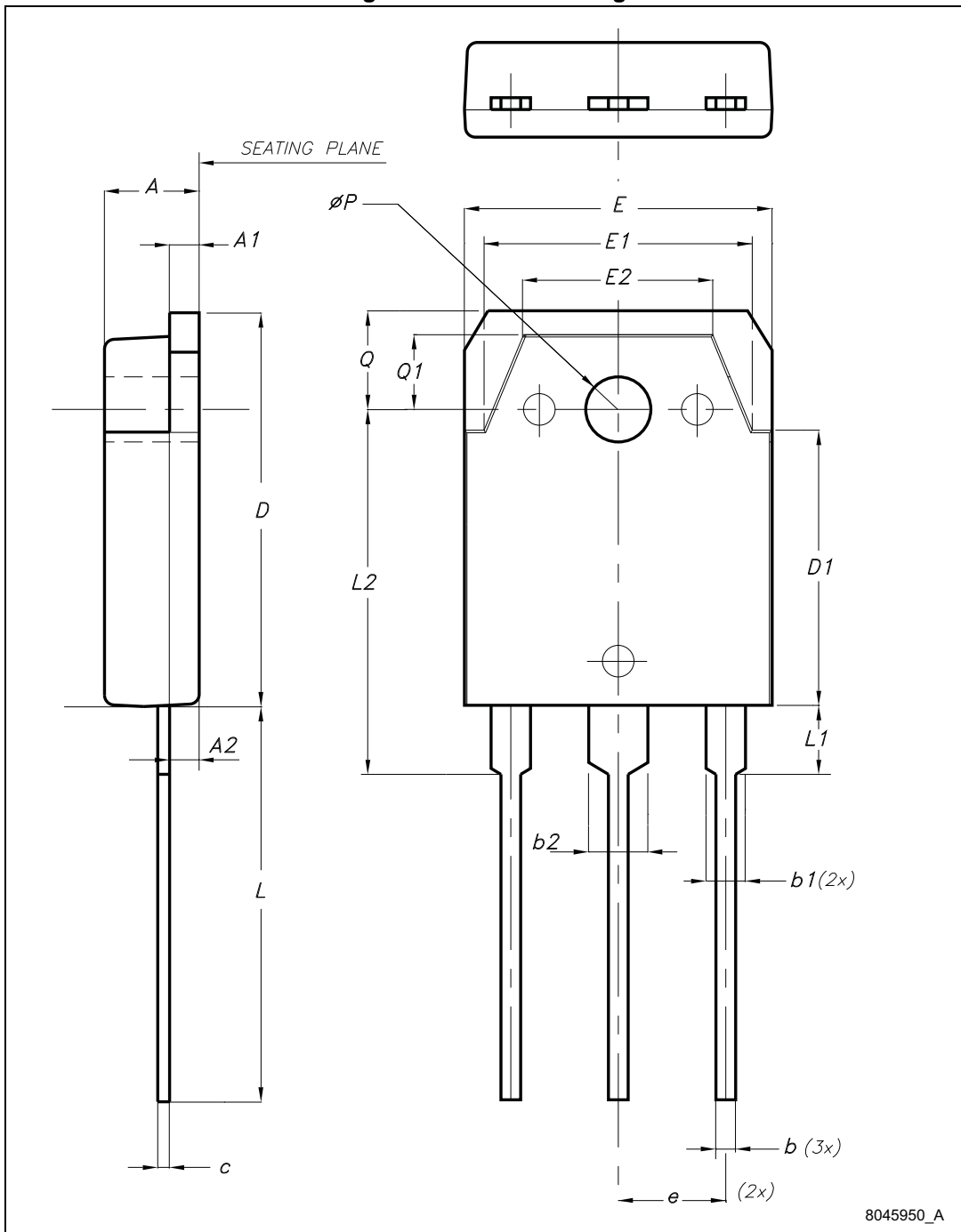

Table 10. TO-3P mechanical data

Dim.	mm		
	Min.	Typ.	Max.
A	4.60		5
A1	1.45	1.50	1.65
A2	1.20	1.40	1.60
b	0.80	1	1.20
b1	1.80		2.20
b2	2.80		3.20
c	0.55	0.60	0.75
D	19.70	19.90	20.10
D1		13.90	
E	15.40		15.80
E1		13.60	
E2		9.60	
e	5.15	5.45	5.75
L	19.50	20	20.50
L1		3.50	
L2	18.20	18.40	18.60
øP	3.10		3.30
Q		5	
Q1		3.80	

## 5 Revision history

Table 11. Document revision history

Date	Revision	Changes
20-Mar-2013	1	Initial release.
17-Apr-2013	2	Document status promoted from preliminary data to production data. Added: <a href="#">Section 2.1: Electrical characteristics (curves)</a>
04-Jun-2013	3	Added minimum and maximum values for $V_{GE(th)}$ in <a href="#">Table 4: Static characteristics</a> .
11-Sep-2013	4	Updated $V_F$ value in <a href="#">Table 4: Static characteristics</a> .
08-Oct-2013	5	Updated title, features and description in cover page.
10-Jan-2014	6	Updated <a href="#">Figure 8: <math>V_{CE(sat)}</math> vs. junction temperature</a> , <a href="#">Figure 15: Diode <math>V_F</math> vs. forward current</a> and <a href="#">Figure 16: Normalized <math>V_{GE(th)}</math> vs junction temperature</a> .
03-Mar-2014	7	Updated test conditions in <a href="#">Table 7: Diode switching characteristics (inductive load)</a> .
23-Apr-2014	8	Added new device in TO-3PF. Updated <a href="#">Table 1: Device summary</a> , <a href="#">Table 2: Absolute maximum ratings</a> <a href="#">Table 3: Thermal data</a> and <a href="#">Section 4: Package mechanical data</a> . Added <a href="#">Figure 4: Power dissipation vs. case temperature for TO-3PF</a> , <a href="#">Figure 5: Collector current vs. case temperature for TO-3PF</a> , <a href="#">Figure 11: Collector current vs. switching frequency for TO-3PF</a> and <a href="#">Figure 12: Forward bias safe operating area for TO-247 and TO-3P</a> . Minor text changes.

**Please Read Carefully:**

Information in this document is provided solely in connection with ST products. STMicroelectronics NV and its subsidiaries ("ST") reserve the right to make changes, corrections, modifications or improvements, to this document, and the products and services described herein at any time, without notice.

All ST products are sold pursuant to ST's terms and conditions of sale.

Purchasers are solely responsible for the choice, selection and use of the ST products and services described herein, and ST assumes no liability whatsoever relating to the choice, selection or use of the ST products and services described herein.

No license, express or implied, by estoppel or otherwise, to any intellectual property rights is granted under this document. If any part of this document refers to any third party products or services it shall not be deemed a license grant by ST for the use of such third party products or services, or any intellectual property contained therein or considered as a warranty covering the use in any manner whatsoever of such third party products or services or any intellectual property contained therein.

**UNLESS OTHERWISE SET FORTH IN ST'S TERMS AND CONDITIONS OF SALE ST DISCLAIMS ANY EXPRESS OR IMPLIED WARRANTY WITH RESPECT TO THE USE AND/OR SALE OF ST PRODUCTS INCLUDING WITHOUT LIMITATION IMPLIED WARRANTIES OF MERCHANTABILITY, FITNESS FOR A PARTICULAR PURPOSE (AND THEIR EQUIVALENTS UNDER THE LAWS OF ANY JURISDICTION), OR INFRINGEMENT OF ANY PATENT, COPYRIGHT OR OTHER INTELLECTUAL PROPERTY RIGHT.**

**ST PRODUCTS ARE NOT DESIGNED OR AUTHORIZED FOR USE IN: (A) SAFETY CRITICAL APPLICATIONS SUCH AS LIFE SUPPORTING, ACTIVE IMPLANTED DEVICES OR SYSTEMS WITH PRODUCT FUNCTIONAL SAFETY REQUIREMENTS; (B) AERONAUTIC APPLICATIONS; (C) AUTOMOTIVE APPLICATIONS OR ENVIRONMENTS, AND/OR (D) AEROSPACE APPLICATIONS OR ENVIRONMENTS. WHERE ST PRODUCTS ARE NOT DESIGNED FOR SUCH USE, THE PURCHASER SHALL USE PRODUCTS AT PURCHASER'S SOLE RISK, EVEN IF ST HAS BEEN INFORMED IN WRITING OF SUCH USAGE, UNLESS A PRODUCT IS EXPRESSLY DESIGNATED BY ST AS BEING INTENDED FOR "AUTOMOTIVE, AUTOMOTIVE SAFETY OR MEDICAL" INDUSTRY DOMAINS ACCORDING TO ST PRODUCT DESIGN SPECIFICATIONS. PRODUCTS FORMALLY ESCC, QML OR JAN QUALIFIED ARE DEEMED SUITABLE FOR USE IN AEROSPACE BY THE CORRESPONDING GOVERNMENTAL AGENCY.**

Resale of ST products with provisions different from the statements and/or technical features set forth in this document shall immediately void any warranty granted by ST for the ST product or service described herein and shall not create or extend in any manner whatsoever, any liability of ST.

ST and the ST logo are trademarks or registered trademarks of ST in various countries.

Information in this document supersedes and replaces all information previously supplied.

The ST logo is a registered trademark of STMicroelectronics. All other names are the property of their respective owners.

© 2014 STMicroelectronics - All rights reserved

STMicroelectronics group of companies

Australia - Belgium - Brazil - Canada - China - Czech Republic - Finland - France - Germany - Hong Kong - India - Israel - Italy - Japan - Malaysia - Malta - Morocco - Philippines - Singapore - Spain - Sweden - Switzerland - United Kingdom - United States of America

[www.st.com](http://www.st.com)

