

N-channel 600 V, 0.094 Ω typ., 28 A MDmesh™ DM2 Power MOSFET in a TO-220FP package

Datasheet - production data

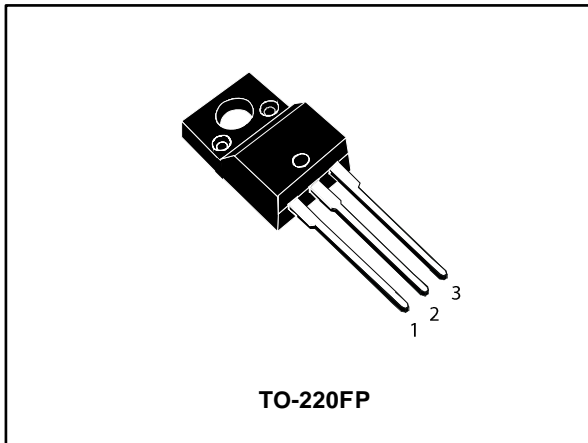
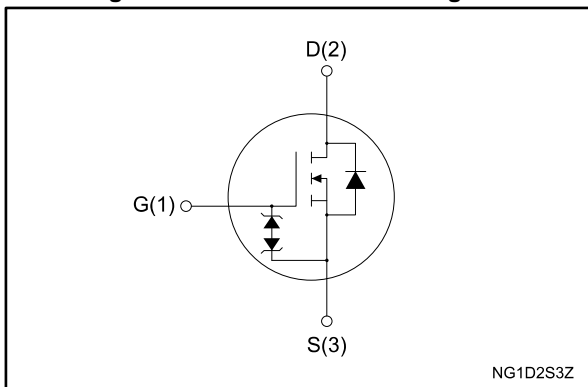

Figure 1: Internal schematic diagram



Features

Order code	V _{DS}	R _{DS(on)} max.	I _D	P _{TOT}
STF35N60DM2	600 V	0.110 Ω	28 A	40 W

- Fast-recovery body diode
- Extremely low gate charge and input capacitance
- Low on-resistance
- 100% avalanche tested
- Extremely high dv/dt ruggedness
- Zener-protected

Applications

- Switching applications

Description

This high voltage N-channel Power MOSFET is part of the MDmesh™ DM2 fast recovery diode series. It offers very low recovery charge (Q_{rr}) and time (t_{rr}) combined with low $R_{DS(on)}$, rendering it suitable for the most demanding high efficiency converters and ideal for bridge topologies and ZVS phase-shift converters.

Table 1: Device summary

Order code	Marking	Package	Packing
STF35N60DM2	35N60DM2	TO-220FP	Tube

Contents

1	Electrical ratings	3
2	Electrical characteristics	4
	2.1 Electrical characteristics (curves).....	6
3	Test circuits	8
4	Package information	9
	4.1 TO-220FP package information	10
5	Revision history	12

1 Electrical ratings

Table 2: Absolute maximum ratings

Symbol	Parameter	Value	Unit
V_{GS}	Gate-source voltage	± 25	V
$I_D^{(1)}$	Drain current (continuous) at $T_{case} = 25\text{ }^\circ\text{C}$	28	A
	Drain current (continuous) at $T_{case} = 100\text{ }^\circ\text{C}$	17	
$I_{DM}^{(2)}$	Drain current (pulsed)	112	A
P_{TOT}	Total dissipation at $T_{case} = 25\text{ }^\circ\text{C}$	40	W
$dv/dt^{(3)}$	Peak diode recovery voltage slope	50	V/ns
$dv/dt^{(4)}$	MOSFET dv/dt ruggedness	50	
V_{ISO}	Insulation withstand voltage (RMS) from all three leads to external heat sink ($t = 1\text{ s}$; $T_c = 25\text{ }^\circ\text{C}$)	2.5	kV
T_{stg}	Storage temperature	-55 to 150	$^\circ\text{C}$
T_j	Operating junction temperature		

Notes:

- (1) Limited by maximum junction temperature.
 (2) Pulse width is limited by safe operating area.
 (3) $I_{SD} \leq 28\text{ A}$, $di/dt=900\text{ A}/\mu\text{s}$; $V_{DS\text{ peak}} < V_{(BR)DSS}$, $V_{DD} = 400\text{ V}$
 (4) $V_{DS} \leq 480\text{ V}$.

Table 3: Thermal data

Symbol	Parameter	Value	Unit
$R_{thj-case}$	Thermal resistance junction-case	3.1	$^\circ\text{C}/\text{W}$
$R_{thj-amb}$	Thermal resistance junction-amb	62.5	

Table 4: Avalanche characteristics

Symbol	Parameter	Value	Unit
I_{AR}	Avalanche current, repetitive or not repetitive	6	A
$E_{AS}^{(1)}$	Single pulse avalanche energy	650	mJ

Notes:

- (1) starting $T_j = 25\text{ }^\circ\text{C}$, $I_D = I_{AR}$, $V_{DD} = 50\text{ V}$.

2 Electrical characteristics

($T_{\text{case}} = 25\text{ °C}$ unless otherwise specified)

Table 5: Static

Symbol	Parameter	Test conditions	Min.	Typ.	Max.	Unit
$V_{(\text{BR})\text{DSS}}$	Drain-source breakdown voltage	$V_{\text{GS}} = 0\text{ V}$, $I_{\text{D}} = 1\text{ mA}$	600			V
I_{DSS}	Zero gate voltage drain current	$V_{\text{GS}} = 0\text{ V}$, $V_{\text{DS}} = 600\text{ V}$			10	μA
		$V_{\text{GS}} = 0\text{ V}$, $V_{\text{DS}} = 600\text{ V}$, $T_{\text{case}} = 125\text{ °C}$			100	
I_{GSS}	Gate-body leakage current	$V_{\text{DS}} = 0\text{ V}$, $V_{\text{GS}} = \pm 25\text{ V}$			± 5	μA
$V_{\text{GS(th)}}$	Gate threshold voltage	$V_{\text{DS}} = V_{\text{GS}}$, $I_{\text{D}} = 250\text{ }\mu\text{A}$	3	4	5	V
$R_{\text{DS(on)}}$	Static drain-source on-resistance	$V_{\text{GS}} = 10\text{ V}$, $I_{\text{D}} = 14\text{ A}$		0.094	0.11	Ω

Table 6: Dynamic

Symbol	Parameter	Test conditions	Min.	Typ.	Max.	Unit
C_{iss}	Input capacitance	$V_{\text{DS}} = 100\text{ V}$, $f = 1\text{ MHz}$, $V_{\text{GS}} = 0\text{ V}$	-	2400	-	μF
C_{oss}	Output capacitance		-	110	-	
C_{riss}	Reverse transfer capacitance		-	2.8	-	
$C_{\text{oss eq.}}^{(1)}$	Equivalent output capacitance	$V_{\text{DS}} = 0\text{ to }480\text{ V}$, $V_{\text{GS}} = 0\text{ V}$	-	190	-	μF
R_{G}	Intrinsic gate resistance	$f = 1\text{ MHz}$, $I_{\text{D}} = 0\text{ A}$	-	4.3	-	Ω
Q_{g}	Total gate charge	$V_{\text{DD}} = 480\text{ V}$, $I_{\text{D}} = 28\text{ A}$, $V_{\text{GS}} = 10\text{ V}$ (see Figure 15: "Test circuit for gate charge behavior")	-	54	-	nC
Q_{gs}	Gate-source charge		-	14.6	-	
Q_{gd}	Gate-drain charge		-	24.2	-	

Notes:

⁽¹⁾ $C_{\text{oss eq.}}$ is defined as a constant equivalent capacitance giving the same charging time as C_{oss} when V_{DS} increases from 0 to 80% V_{DSS} .

Table 7: Switching times

Symbol	Parameter	Test conditions	Min.	Typ.	Max.	Unit
$t_{d(on)}$	Turn-on delay time	$V_{DD} = 300\text{ V}$, $I_D = 14\text{ A}$ $R_G = 4.7\ \Omega$, $V_{GS} = 10\text{ V}$ (see Figure 14: "Test circuit for resistive load switching times" and Figure 19: "Switching time waveform")	-	21.2	-	ns
t_r	Rise time		-	17	-	
$t_{d(off)}$	Turn-off delay time		-	68	-	
t_f	Fall time		-	10.7	-	

Table 8: Source-drain diode

Symbol	Parameter	Test conditions	Min.	Typ.	Max.	Unit
I_{SD}	Source-drain current		-		28	A
$I_{SDM}^{(1)}$	Source-drain current (pulsed)		-		112	A
$V_{SD}^{(2)}$	Forward on voltage	$V_{GS} = 0\text{ V}$, $I_{SD} = 28\text{ A}$	-		1.6	V
t_{rr}	Reverse recovery time	$I_{SD} = 28\text{ A}$, $di/dt = 100\text{ A}/\mu\text{s}$, $V_{DD} = 60\text{ V}$ (see Figure 16: "Test circuit for inductive load switching and diode recovery times")	-	120		ns
Q_{rr}	Reverse recovery charge		-	572		nC
I_{RRM}	Reverse recovery current		-	10.2		A
t_{rr}	Reverse recovery time	$I_{SD} = 28\text{ A}$, $di/dt = 100\text{ A}/\mu\text{s}$, $V_{DD} = 60\text{ V}$, $T_j = 150\text{ }^\circ\text{C}$ (see Figure 16: "Test circuit for inductive load switching and diode recovery times")	-	215		ns
Q_{rr}	Reverse recovery charge		-	1.89		μC
I_{RRM}	Reverse recovery current		-	17.7		A

Notes:

(1) Pulse width is limited by safe operating area.

(2) Pulse test: pulse duration = 300 μs , duty cycle 1.5%.

Table 9: Gate-source Zener diode

Symbol	Parameter	Test conditions	Min.	Typ.	Max.	Unit
$V_{(BR)GSO}$	Gate-source breakdown voltage	$I_{GS} = \pm 250\ \mu\text{A}$, $I_D = 0\text{ A}$	± 30	-	-	V

The built-in back-to-back Zener diodes are specifically designed to enhance the ESD performance of the device. The Zener voltage facilitates efficient and cost-effective device integrity protection, thus eliminating the need for additional external componentry.

2.1 Electrical characteristics (curves)

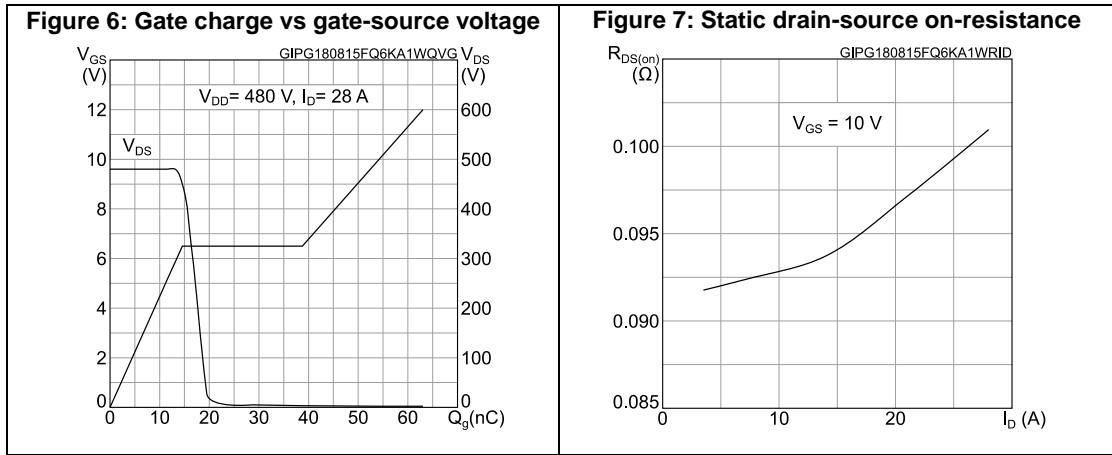
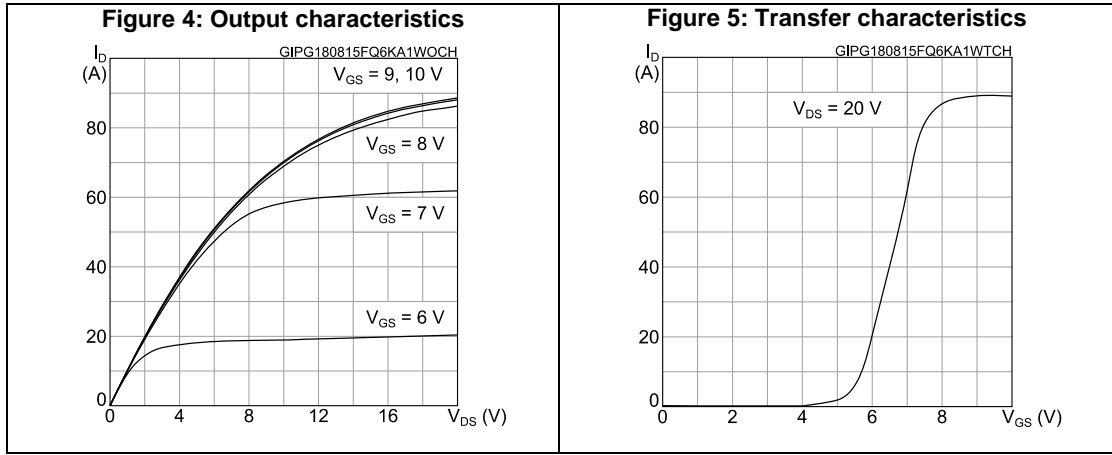
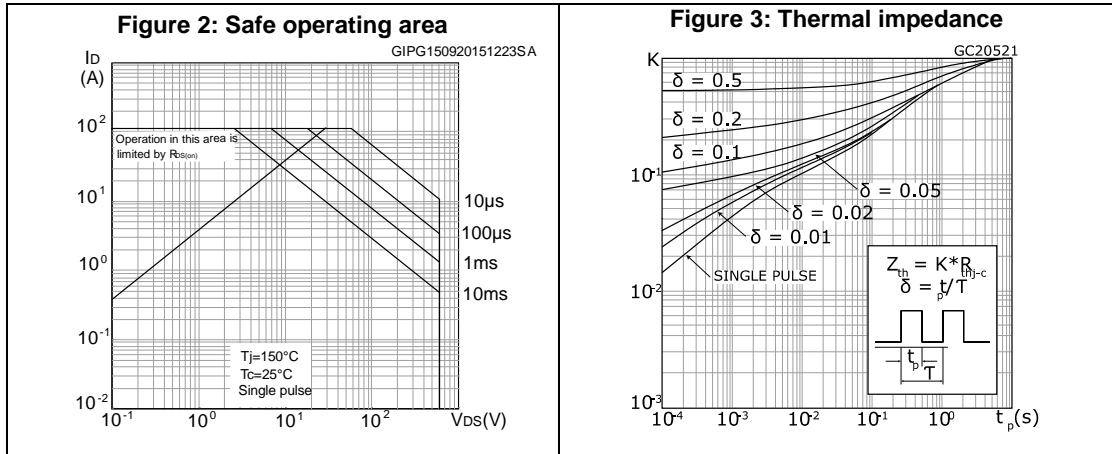

Figure 8: Capacitance variations

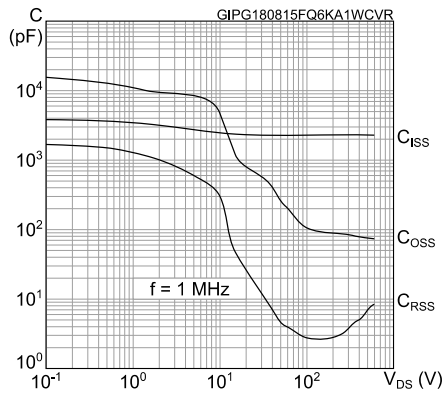

Figure 9: Normalized gate threshold voltage vs temperature

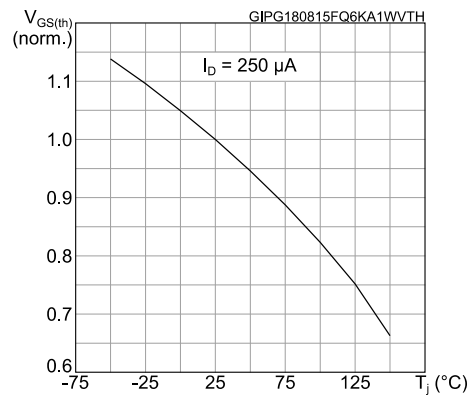

Figure 10: Normalized on-resistance vs temperature

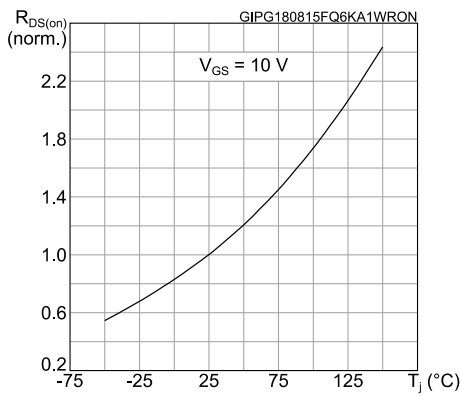

Figure 11: Normalized V(BR)DSS vs temperature

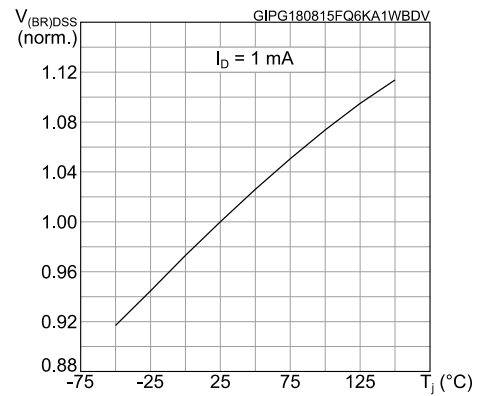

Figure 12: Output capacitance stored energy

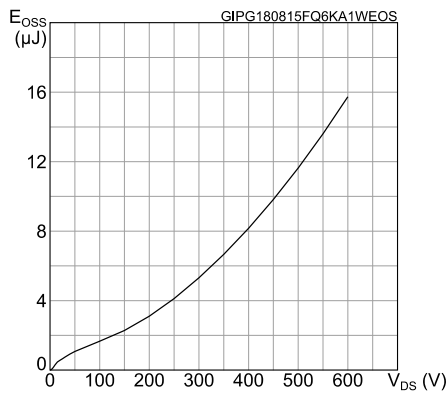
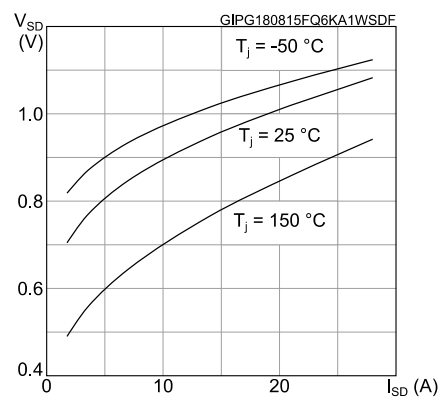

Figure 13: Source-drain diode forward characteristics



3 Test circuits

Figure 14: Test circuit for resistive load switching times



AM01468v1

Figure 15: Test circuit for gate charge behavior

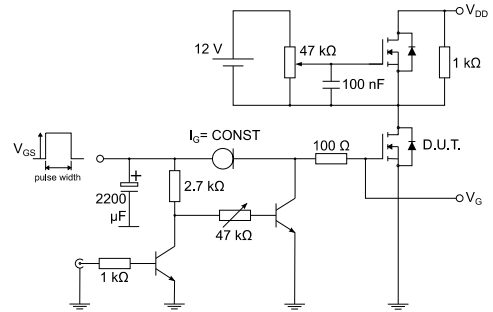

AM01469v1

Figure 16: Test circuit for inductive load switching and diode recovery times

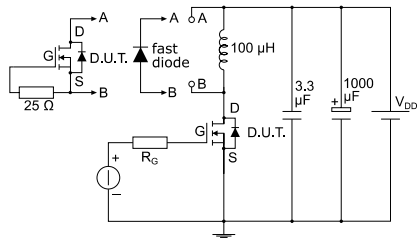

AM01470v1

Figure 17: Unclamped inductive load test circuit

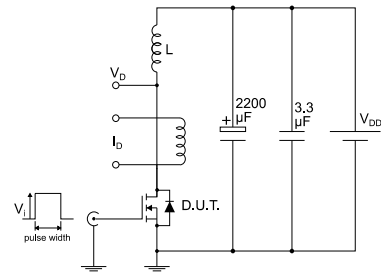

AM01471v1

Figure 18: Unclamped inductive waveform

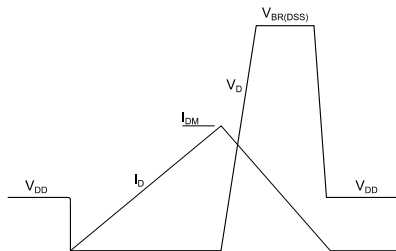

AM01472v1

Figure 19: Switching time waveform

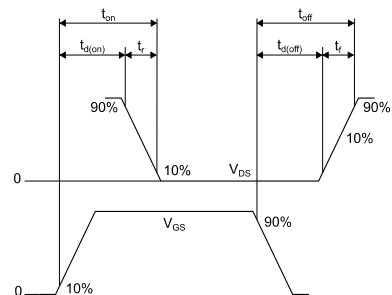

AM01473v1

4 Package information

In order to meet environmental requirements, ST offers these devices in different grades of ECOPACK[®] packages, depending on their level of environmental compliance. ECOPACK[®] specifications, grade definitions and product status are available at: www.st.com. ECOPACK[®] is an ST trademark.

4.1 TO-220FP package information

Figure 20: TO-220FP package outline

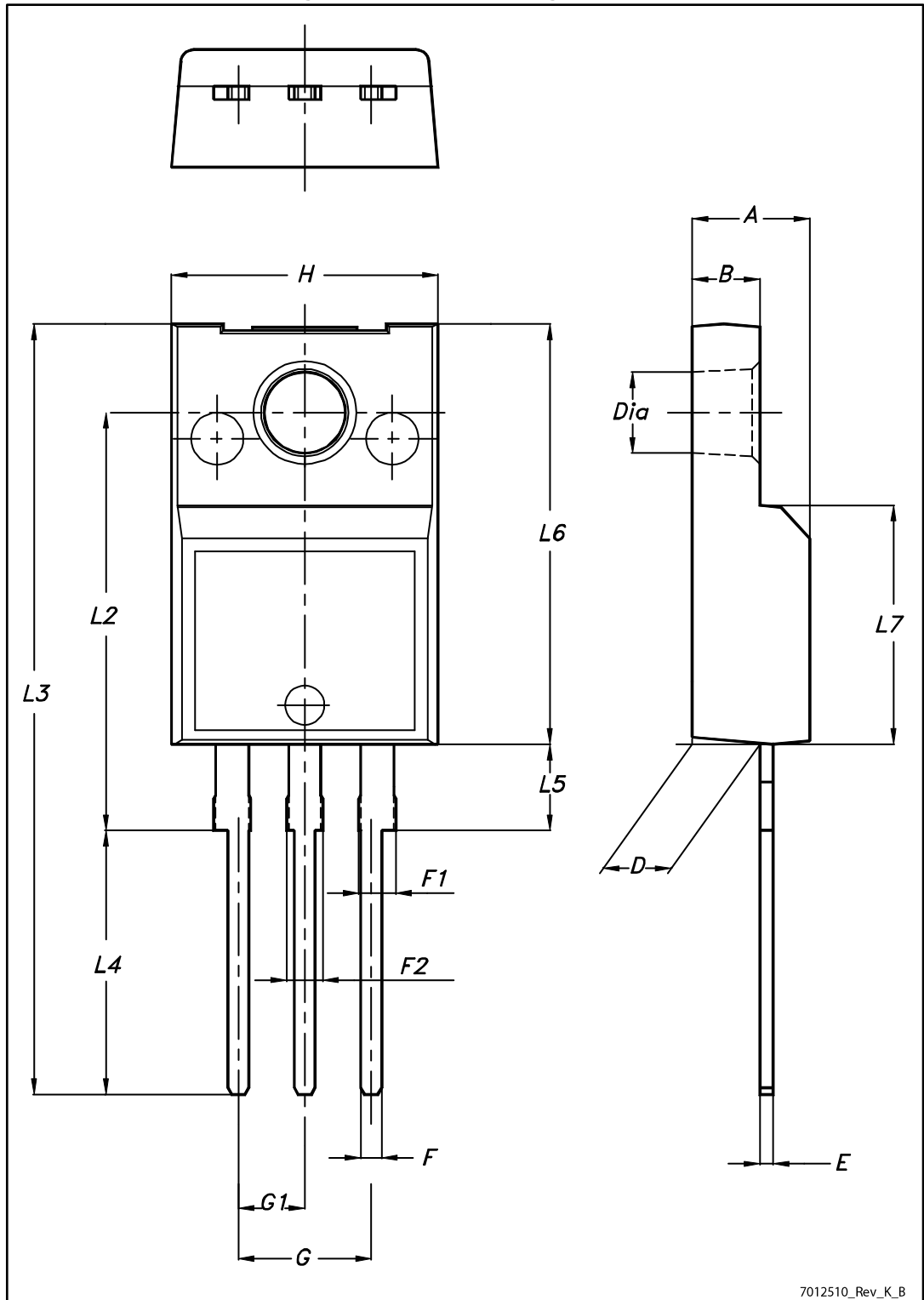

7012510_Rev_K_B

Table 10: TO-220FP package mechanical data

Dim.	mm		
	Min.	Typ.	Max.
A	4.4		4.6
B	2.5		2.7
D	2.5		2.75
E	0.45		0.7
F	0.75		1
F1	1.15		1.70
F2	1.15		1.70
G	4.95		5.2
G1	2.4		2.7
H	10		10.4
L2		16	
L3	28.6		30.6
L4	9.8		10.6
L5	2.9		3.6
L6	15.9		16.4
L7	9		9.3
Dia	3		3.2

5 Revision history

Table 11: Document revision history

Date	Revision	Changes
15-Sep-2015	1	Initial version

IMPORTANT NOTICE – PLEASE READ CAREFULLY

STMicroelectronics NV and its subsidiaries ("ST") reserve the right to make changes, corrections, enhancements, modifications, and improvements to ST products and/or to this document at any time without notice. Purchasers should obtain the latest relevant information on ST products before placing orders. ST products are sold pursuant to ST's terms and conditions of sale in place at the time of order acknowledgement.

Purchasers are solely responsible for the choice, selection, and use of ST products and ST assumes no liability for application assistance or the design of Purchasers' products.

No license, express or implied, to any intellectual property right is granted by ST herein.

Resale of ST products with provisions different from the information set forth herein shall void any warranty granted by ST for such product.

ST and the ST logo are trademarks of ST. All other product or service names are the property of their respective owners.

Information in this document supersedes and replaces information previously supplied in any prior versions of this document.

© 2015 STMicroelectronics – All rights reserved