

Flush-type connector - SACC-DSI-MSD-4CON-L180/12SCOSH - 1558519

Please be informed that the data shown in this PDF Document is generated from our Online Catalog. Please find the complete data in the user's documentation. Our General Terms of Use for Downloads are valid (<http://download.phoenixcontact.com>)



Bus system flush-type plug, ETHERNET, 4-pos., M12 SPEEDCON, shielded, D-coded, rear/screw mounting with Pg9 thread, with straight solder connection, design with 12 mm long solder pins



Ethernet



Key commercial data

Packing unit	1 1
Minimum order quantity	20 1
Custom tariff number	85366990
Country of origin	Germany

Technical data

Dimensions

Length of the solder pin	12 mm
--------------------------	-------

Ambient conditions

Ambient temperature (operation)	-25 °C ... 85 °C (Plug / socket)
Degree of protection	IP67

General

Note	This product corresponds to the PROFINET Cabling and Interconnection Technology Guideline for PROFINET regulations, version 2.00, order no: 2.252, Chapter 8.2 Connectors for Outside Environment (Balanced cabling)
Rated current at 40°C	4 A
Rated voltage	250 V
Number of positions	4
Contact resistance	≤ 3 mΩ
Insulation resistance	≥ 100 MΩ
Coding	D - data

Flush-type connector - SACC-DSI-MSD-4CON-L180/12SCOSH - 1558519

Technical data

General

Standards/regulations	M12 connector IEC 61076-2-101
Status display	No
Surge voltage category	II
Pollution degree	3
Connection method	Solder pins
Mounting type	Rear mounting Pg9 With flat nut

Material

Inflammability class according to UL 94	V0
Contact material	CuZn
Contact surface material	Au
Contact carrier material	PA 66
Material, knurls	Zinc die-cast, nickel-plated
Sealing material	NBR

Classifications

eCl@ss

eCl@ss 4.0	27250313
eCl@ss 4.1	27250313
eCl@ss 5.0	27143423
eCl@ss 5.1	27143423
eCl@ss 6.0	27143423
eCl@ss 7.0	27449001
eCl@ss 8.0	27449001

ETIM

ETIM 3.0	EC002061
ETIM 4.0	EC002061
ETIM 5.0	EC002062

UNSPSC

UNSPSC 6.01	31261501
UNSPSC 7.0901	31261501
UNSPSC 11	31261501
UNSPSC 12.01	31261501
UNSPSC 13.2	31261501

Flush-type connector - SACC-DSI-MSD-4CON-L180/12SCOSH - 1558519

Approvals

Approvals

Approvals

UL Recognized / GOST / GOST

Ex Approvals

Approvals submitted

Approval details

UL Recognized 	
mm ² /AWG/kcmil	26-20
Nominal current I _N	4 A
Nominal voltage U _N	250 V

GOST 
--

GOST 
--

Drawings

Flush-type connector - SACC-DSI-MSD-4CON-L180/12SCOSH - 1558519

Dimensioned drawing

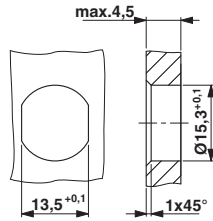

Schematic diagram

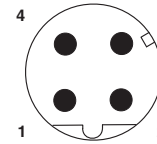

Pin assignment M12 male connector, 4-pos., D-coded, male side

Housing cutout for Pg9 fastening thread, mounting panel with feed-through hole (alternatively with surface as protection against rotation)

Drilling diagram

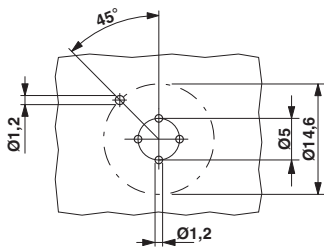

Drilling diagram

Dimensioned drawing

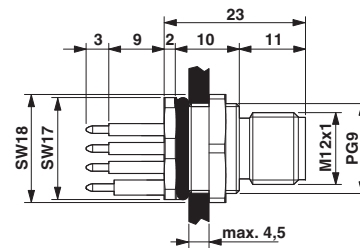

M12 SPEEDCON flush-type plug

Dimensioned drawing

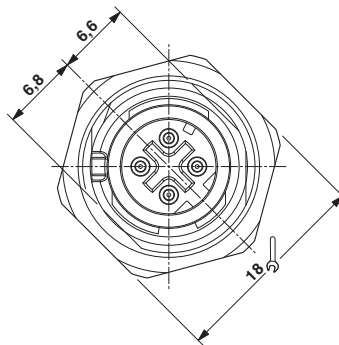

M12 front view