



LED Display Product Data Sheet LTS-50801HRB

Spec No.: DS-30-98-250

Effective Date: 04/21/2000

Revision: -

LITE-ON DCC

RELEASE

BNS-OD-FC001/A4

FEATURES

- * 5-INCH (127.0-mm) DIGIT HEIGHT.
- * CONTINUOUS UNIFORM SEGMENTS.
- * LOW POWER REQUIREMENT.
- * EXCELLENT CHARACTERS APPEARANCE.
- * HIGH BRIGHTNESS & HIGH CONTRAST.
- * WIDE VIEWING ANGLE.
- * SOLID STATE RELIABILITY.
- * CATEGORIZED FOR LUMINOUS INTENSITY.

DESCRIPTION

The LTS-50801HRB is a 5-inch (127.0-mm) digit height single digit seven-segment display. This device utilizes hi-eff. red LED chips, which are made from GaAsP on GaP substrate, and has a black face and red segments.

DEVICE

PART NO.	DESCRIPTION
HI-EFF. RED	Common Anode
LTS-50801HRB	

PACKAGE DIMENSIONS

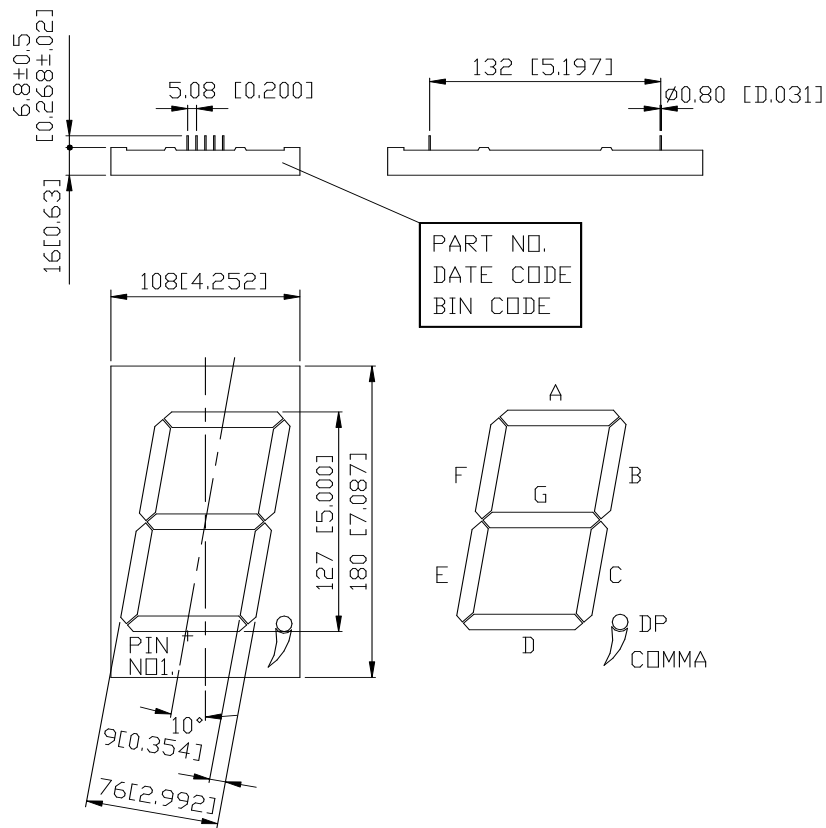

NOTES: All dimensions are in millimeters. Tolerance is ± 0.25-mm (0.01") unless otherwise noted.

INTERNAL CIRCUIT DIAGRAM

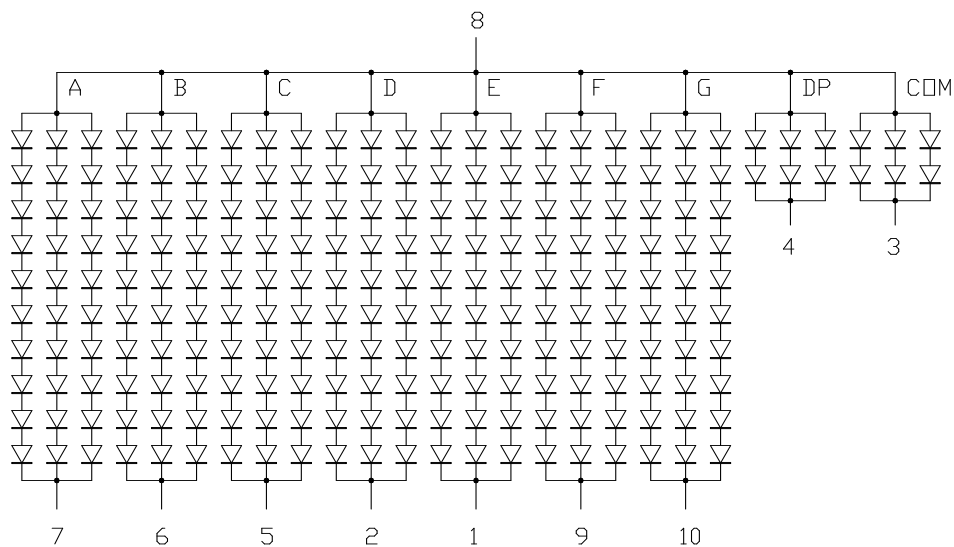

PIN CONNECTION

No.	CONNECTION
1	SEGMENT E CATHODE
2	SEGMENT D CATHODE
3	COMMA CATHODE
4	D.P. CATHODE
5	SEGMENT C CATHODE
6	SEGMENT B CATHODE
7	SEGMENT A CATHODE
8	COMMON ANODE
9	SEGMENT F CATHODE
10	SEGMENT G CATHODE

ABSOLUTE MAXIMUM RATING AT Ta=25°C

PARAMETER	MAXIMUM RATING	UNIT
Power Dissipation Per Segment	1200	mW
Peak Forward Current Per Segment (1/10 Duty Cycle, 0.1ms Pulse Width)	180	mA
Continuous Forward Current Per Segment	60	mA
Derating Linear From 25°C Per Segment	0.72	mA/°C
Reverse Voltage Per Segment	50	V
Operating Temperature Range	-35°C to +85°C	
Storage Temperature Range	-35°C to +85°C	
Solder Temperature 1/16 inch Below Seating Plane for 3 Seconds at 260°C		

ELECTRICAL / OPTICAL CHARACTERISTICS AT Ta=25°C

PARAMETER	SYMBOL	MIN.	TYP.	MAX.	UNIT	TEST CONDITION
Average Luminous Intensity	I _v	21	60		mcd	I _F =30mA
Peak Emission Wavelength	λ _p		635		nm	I _F =20mA
Spectral Line Half-Width	Δλ		40		nm	I _F =20mA
Dominant Wavelength	λ _d		623		nm	I _F =20mA
Forward Voltage Per Segment	V _F		20 (4.0)	26 (5.2)	V	I _F =60mA
Reverse Current Per Segment	I _R			300	μA	V _R =50V
Luminous Intensity Matching Ratio	I _{v-m}			2:1		I _F =10mA

Note: Luminous intensity is measured with a light sensor and filter combination that approximates the CIE (Commission internationale DE L'Eclairage) eye-response curve.

TYPICAL ELECTRICAL / OPTICAL CHARACTERISTIC CURVES

(25°C Ambient Temperature Unless Otherwise Noted)

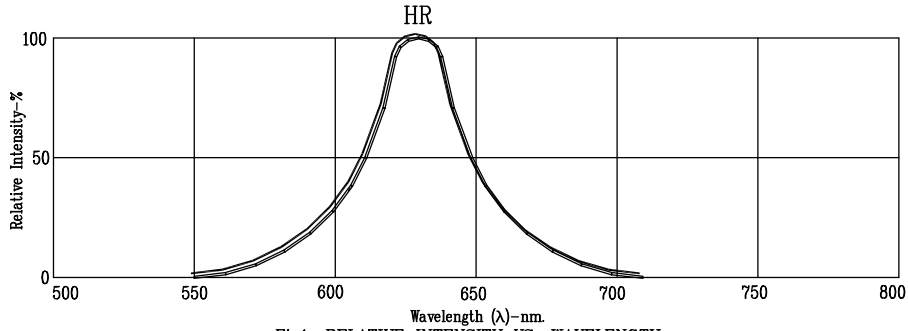

Fig1. RELATIVE INTENSITY VS. WAVELENGTH

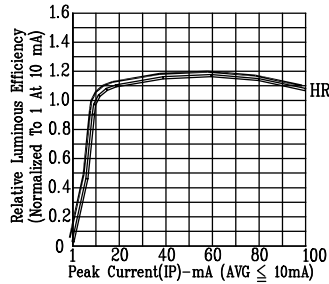

Fig2. RELATIVE LUMINOUS EFFICIENCY (LUMINOUS INTENSITY PER UNIT CURRENT) VS. PEAK CURRENT (REFRESH RATE 1KHz)

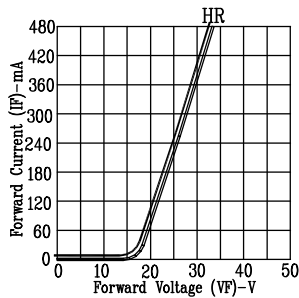

Fig3. FORWARD CURRENT VS. FORWARD VOLTAGE

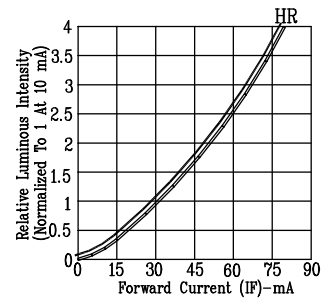

Fig4. RELATIVE LUMINOUS INTENSITY VS. FORWARD CURRENT

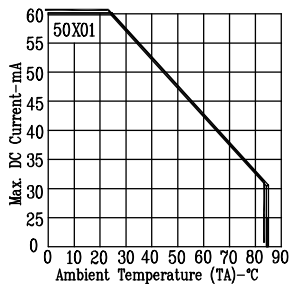

Fig5. MAX ALLOWABLE DC CURRENT VS. AMBIENT TEMPERATURE.

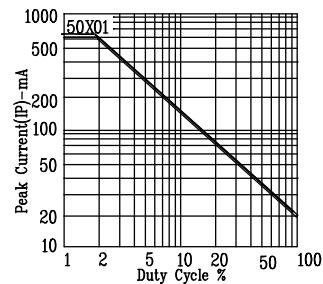

Fig6. MAX PEAK CURRENT VS. DUTY CYCLE % (REFRESH RATE 1KHz)

NOTE : HR=HL EFF. RED