

Make: Getting Started with Adafruit Trinket

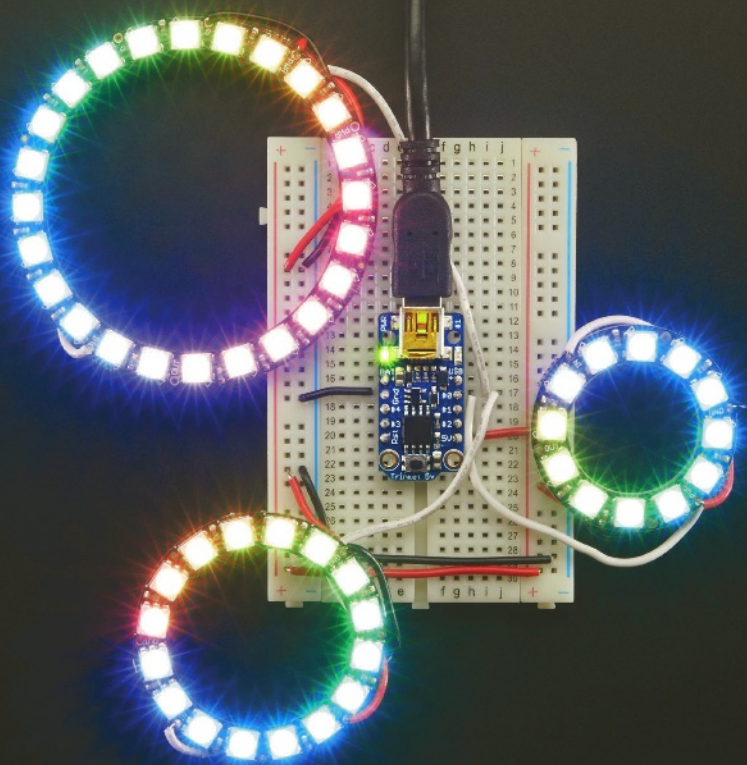

15 Projects with the Low-Cost
AVR ATtiny85 Board

Mike Barela

foreword by Limor 'Ladyada' Fried

Getting Started with Adafruit Trinket

Mike Barela



Getting Started with Adafruit Trinket

by Mike Barela

Copyright © 2015 Mike Barela. All rights reserved.

Printed in the United States of America.

Published by Maker Media, Inc., 1005 Gravenstein Highway North, Sebastopol, CA 95472.

Maker Media books may be purchased for educational, business, or sales promotional use. Online editions are also available for most titles (<http://my.safaribooksonline.com>). For more information, contact our corporate/institutional sales department: 800-998-9938 or corporate@oreilly.com.

Editor: Brian Jepson and Emma Dvorak

Production Editor: Matthew Hacker

Copyeditor: Rachel Head

Proofreader: Carla Thornton

Interior Designer: David Futato

Cover Designer: Brian Jepson

Illustrator: Rebecca Demarest

Cover Photographer: Andrew Tingle

October 2014: First Edition

Revision History for the First Edition

2014-09-25: First Release

See <http://oreilly.com/catalog/errata.csp?isbn=9781457185946> for release details.

Make:, Maker Shed, and Maker Faire are registered trademarks of Maker Media, Inc. The Maker Media logo is a trademark of Maker Media, Inc. *Getting Started with Adafruit Trinket* and related trade dress are trademarks of Maker Media, Inc.

Many of the designations used by manufacturers and sellers to distinguish their products are claimed as trademarks. Where those designations appear in this book, and Maker Media, Inc. was aware of a trademark claim, the designations have been printed in caps or initial caps.

While every precaution has been taken in the preparation of this book, the publisher and authors assume no responsibility for errors or omissions, or for damages resulting from the use of the information contained herein.

978-1-457-18594-6

[LSI]

Contents

Foreword	ix
Preface	xi
1/Introducing Trinket	1
Trinket Versus Arduino Uno	2
Using Trinket	3
The ATtiny85 Microcontroller	3
Memory	4
Connectivity	5
Three Volts or Five Volts?	7
The Adafruit Gemma	8
2/Software Installation	9
Supported Operating Systems	10
The Preconfigured Arduino IDE from Adafruit	10
Modifying the Standard Arduino IDE	11
The USBtinyISP Driver for Windows	11
Seeing the Trinket in Windows	14
Windows Driver Troubleshooting	15
Linux	15
Conclusion	15
3/Connection and Programming	17
Preparing the Trinket	17
Connecting Trinket to Your Computer	19
Loading a Program	21
The Trinket Data Pins	24
Digital Pins	24
Analog Pins	25
Exploring Data Pins	25
Parts List	25
Connections	26
Not All Pins Are the Same	26

Different Ways to Power Trinket.....	28
Analog and Digital Sensors.....	30
Trinket Theremin.....	30
Parts List.....	30
Wiring.....	31
Code.....	32
Use.....	34
Sound and Music.....	34
Conclusion.....	35
4/Libraries and Optimization.....	37
Arduino Libraries.....	37
ATtiny-Optimized Libraries.....	39
Installing Libraries.....	41
Where to Install Libraries.....	42
Installing a Library in Windows.....	44
Installing a Library in OS X.....	47
Using Libraries.....	49
Library Issues and Limitations.....	50
Memory Optimizations.....	50
Program Space Optimization.....	51
Variable Optimization.....	51
Conclusion.....	53
5/Intermediate Projects.....	55
Controlling Smart LEDs: NeoPixels.....	55
Important Things to Know About NeoPixels.....	56
NeoPixel Packaging.....	57
NeoPixel Ornaments.....	57
Parts List.....	58
Build.....	58
LED Color Organ.....	61
How It Works.....	62
Parts List.....	62
Build.....	63
Adjustments.....	67
Mounting.....	67
Kaleidoscope Goggles.....	68
Parts List.....	69
Tools.....	69
Battery Selection.....	70
Wiring.....	70

Software.....	73
Final Assembly and Use.....	75
Safety and Common Sense.....	77
Servos.....	78
Inside a Servo.....	79
Trinket Servo Control.....	80
Parts List.....	81
Wiring.....	81
Code.....	82
Use.....	83
Going Further.....	83
Using I ² C—The Two-Wire Interface.....	84
I ² C Software.....	85
Using I ² C Displays.....	85
Temperature and Humidity Sensing.....	86
Parts List.....	87
Libraries.....	88
The LCD Display.....	88
Testing the Display.....	90
Adjustment.....	91
Sensing.....	91
Code.....	93
How It Works.....	94
Troubleshooting.....	95
Going Further.....	95
Ultrasonic Ranging.....	96
Parts List.....	97
Build.....	97
Libraries.....	99
Code.....	99
How It Works.....	102
Troubleshooting.....	102
Communicating via Serial.....	102
Talking Serial.....	104
Exploring Serial Use.....	104
Parts List.....	104
Code.....	105
Use.....	106
Going Further.....	108
Pulse Width Modulation.....	108
The Analog Meter Clock.....	110
Circuit Design.....	110

Parts List.....	111
Build.....	111
Meters.....	112
Libraries.....	113
Code.....	113
How It Works.....	115
Preparing Your Meters.....	116
Meter Mounting.....	117
Conclusion.....	119
6/Advanced Projects.....	121
Trinket Jewelry.....	121
Parts List.....	122
Choices.....	122
Tools.....	123
Wiring.....	123
Libraries.....	124
Code.....	125
Animation.....	128
Compile.....	131
Changing the Animation.....	132
Finishing the Jewelry.....	133
Program Memory for Data.....	134
Trinket Occupancy Display.....	135
Parts List.....	136
Tools.....	137
Wiring.....	137
Libraries.....	139
Code.....	139
Enclosure and Board.....	141
Box Connections.....	142
Adjustment.....	143
Room Placement.....	145
Going Further.....	145
Trinket Alarm System.....	146
Parts List.....	147
Tools.....	147
Theory.....	148
Multiple Sensors, One Pin.....	149
Project Design.....	151
Annunciation Selections.....	152
Build.....	153
Populating the Board.....	154

Code	157
Final Assembly	160
Test	161
Troubleshooting	163
Going Further	163
Bluetooth Communication	164
Trinket Toy Animal	165
Choosing Your Animal	165
Parts List	166
Tools	167
Circuit	167
Circuit Variations	168
Code	169
Preparing the Toy	171
Use	173
Trinket Rover Robot	173
Parts List	175
Tools	175
3D Printing	176
Build	176
Wiring	179
Code	181
Going Further	183
SPI Communications	183
Trinket Audio Player	185
Parts List	186
Tools	187
Software	188
Loading Sounds	188
Chip Loading Circuit	189
Transferring Audio	192
Sound Playback	193
Use	197
Conclusion	197
7/Going Further with Trinket	199
Microcontrollers: Smaller Versus Larger	199
The Trinket Bootloader	200
The Bootloader Design	201
Bootloader Code	201
Repairing the Trinket Bootloader	202
Programming Bare ATtiny85 Chips	203

Other AVR Programming Methods.....	204
Community Resources.....	206
Learning Arduino.....	207
Commercial Resources.....	207
Technical Resources.....	208
Third-Party Sites.....	208
Social Media Resources.....	209
8/Troubleshooting.....	211
Your USB Cable.....	211
Connectivity Issues.....	212
Arduino IDE Issues.....	215
Mac.....	215
Common Library Problems.....	217
Error Messages.....	219
Compilation Issues.....	219
Upload Errors.....	221
The Serial Monitor.....	222
Usage Issues.....	222
Manufacturer Support.....	224
A/Making Electronic Sounds.....	225
B/Parts Sourcing.....	231
C/Publications.....	235
Index.....	237

Foreword

I like to talk about electronics and microcontrollers in terms of “BA” and “AA” (that’s Before Arduino and After Arduino, by the way). In the days before Arduino, there were microcontrollers, to be sure. But it was really, really annoying to work with them. UV lamps, EEPROMs, one-time writes, high-voltage programmers! If you wanted to dabble in microcontrollers, the equipment and knowledge requirements were a steep hill to climb. Thanks to the beginner-friendly (but surprisingly powerful) Arduino, millions of engineers, artists, fashion designers, and more have been able to add electronics making to their skillsets.

At Adafruit, we’ve been doing Arduino projects for a very long time, and we’ve noticed that while some people like to push the capabilities to the very edge, there are many people who want something simple and small. A one-key keyboard, or an LED light-up brooch, or a servo driver. In many cases, the Arduino is great for prototyping but is a bit chunky. A smaller, simpler *mini Arduino* can do the job just fine. That’s why we designed the Trinket, a miniature microcontroller board that can do little tasks nicely, and can be programmed similarly to the Arduino.

The Trinket builds on the great work of the Arduino team, including David Mellis, who first added Atmel ATtiny85 chip support to the Arduino development environment. Even though it may seem underpowered, there’s something about the tiny size and simplicity of the Trinket (and its wearable sister, the Gemma) that inspires so many projects.

I’m delighted to introduce Mike Barela as the author of *Getting Started with Adafruit Trinket*. Mike has the deep engineering knowledge to explain the innards of a microcontroller or RC filter, the craftiness to detail how to build LED goggles, and the patience to line-by-line document the dozen projects in this book. As you read *Getting Started with Adafruit Trinket*, you’ll find yourself immersed in the joy of hacking and figuring things out, learning how to tweak just a little bit more out of the little Trinket, while gaining knowledge of the same kinds of topics you’d run into with hulking 32-bit ARM processors.

Please try to build these projects, and—better yet—improve on them! Show them off to your siblings, parents, children, or friends. Give them as gifts, wear them to parties, and show off how much fun it is to Make!

—Limor “Ladyada” Fried, Founder and Engineer, Adafruit

Preface

The Trinket microcontroller provides designers with custom programmability in a size and price range perfect for modern projects. The number of projects using Trinket continues to grow, as witnessed in numerous project builds documented in social media. This book introduces you to some of the possibilities, providing a jumping-off point for your own explorations.

Who This Book Is For

This book is for *you*, the enthusiast who is expanding his knowledge of Making and controlling items through classes or self-study.

Working with Trinket is suitable for beginners, although it is assumed you have some familiarity with what a microcontroller is and with basic programming principles. The book steps through basic projects, working toward more challenging circuits and code. You'll find that I adapt and add concepts to create new functionality. After you complete the book, you can use it as a reference for microcontrollers, sensors, and coding techniques.

You will want to learn how to use the Arduino integrated development environment (IDE) for most of the examples in the book. Arduino compatibles are programmed in a variation of the C programming language with various prebuilt code in libraries. All of the code for the examples is supplied in the book and [online](#). For later projects, familiarity with electronics and project assembly is helpful but not required.

You will be following diagrams illustrating point-to-point wiring of electrical circuits. You'll be working on a solderless breadboard, which makes this easy to complete.

Recommended Reading

There is no required reading to work with this book, but here are some suggested resources that you may draw on to better understand particular subjects:

Component soldering with a soldering iron

The book *Make: Learn to Solder* by Brian Jepson (Maker Media), Tyler Moskowite, and Gregory Hayes is a great reference. An alternative is the "[Collin's Lab: Soldering](#)" tutorial, which you can watch for free online. Both teach the fundamentals of soldering, an essential skill for building electronic gadgets.

Familiarity with Arduino

The book [Getting Started with Arduino](#), Second Edition, by Massimo Banzi (cocreator of Arduino), is a good resource, as is the [Adafruit Learn Arduino series](#), available for free online. Both offer an introduction to the Arduino open source electronics prototyping platform, including programming.

Other resources are listed in "[Learning Arduino](#)" on page 207.

What You Will Want to Have on Hand

To program a Trinket, you will need a Windows or Mac computer with a USB port. Linux may also work, although Adafruit does not guarantee compatibility with all Linux variants due to USB driver issues. Internet access is very helpful for obtaining example code, rather than typing it in yourself. The Internet is also great for reference material on specific subjects. The [Adafruit Learning System](#) and other websites post Trinket-related projects. Here are some other things you'll need to have on hand:

A good USB type A male-to-male Mini-B cable

I cannot stress this enough: get a *good* USB cable for programming the Trinket. Please consider buying a substantial USB type A male end to type Mini-B male cable, 3 feet (1 meter) long or less. So many visitors to Adafruit's Trinket support forum have repurposed old phone charging cables or other questionable cables. Such cables, more often than not, do not have the USB data wires required for communicating between the computer and the Trinket. Worn cables may work intermittently, but a good cable will save you hours of grief.

Basic tools

Soldering iron and solder

You will need a soldering iron and solder, to attach breadboard pins onto the Trinket and for building more permanent electrical circuits.

Multimeter

A multimeter capable of voltage and resistance measurements is a staple of any toolkit and can be purchased for under \$10 or equivalent in most locations.

Pliers and wire cutters

Pliers and wire cutters are *essential*. Wires connect all the parts used in a project. Some other tools might be handy, too, including a drill and screwdriver. Young makers may need assistance with a drill or other sharp tools that might be used in project packaging.

Electrical parts for projects

Most of the parts sourced in the book come from the manufacturer of the Trinket: [Adafruit Industries](#). To gather the parts you are looking for, turn to [Appendix B](#). Adafruit has a good worldwide distribution system. Other hobbyist websites may provide similar parts, but you'll need more knowledge of how they work if they are not electrically the same as the specified parts.



One advanced project uses 3D-printed parts. You can create these yourself (at home, at work, or in a Makerspace) or order them from a 3D printing service at a nominal cost.

Overall, working with the Trinket requires the same skills and materials as working with other hobbyist electronic items.

Conventions Used in This Book

The following typographical conventions are used in this book:

Italic

Indicates new terms, URLs, email addresses, filenames, and file extensions.

Constant width

Used for program listings, as well as within paragraphs to refer to program elements such as variable or function names, databases, data types, environment variables, statements, and keywords.

Constant width bold

Shows commands or other text that should be typed literally by the user.

Constant width italic

Shows text that should be replaced with user-supplied values or by values determined by context.



This element signifies a tip, suggestion, or general note.



This element indicates a warning or caution.

Using Code Examples

This book is here to help you get your job done. In general, you may use the code in this book in your programs and documentation. You do not need to contact us for permission unless you're reproducing a significant portion of the code. For example, writing a program that uses several chunks of code from this book does not require permission. Selling or distributing a CD-ROM of examples from *Make: books* does require permission. Answering a question by citing this book and quoting example code does not require permission. Incorporating a significant amount of example code from this book into your product's documentation does require permission.

We appreciate, but do not require, attribution. An attribution usually includes the title, author, publisher, and ISBN. For example: "*Getting Started with Adafruit Trinket* by Mike Barela (Maker Media). Copyright 2015, 978-1-457-18594-6."

If you feel your use of code examples falls outside fair use or the permission given here, feel free to contact us at bookpermissions@makermedia.com.

Safari® Books Online

[Safari Books Online](#) is an on-demand digital library that delivers expert content in both book and video form from the world's leading authors in technology and business.

Technology professionals, software developers, web designers, and business and creative professionals use Safari Books Online as their primary resource for research, problem solving, learning, and certification training.

Safari Books Online offers a range of [plans and pricing](#) for [enterprise](#), [government](#), [education](#), and individuals.

Members have access to thousands of books, training videos, and prepublication manuscripts in one fully searchable database from publishers like Maker Media, O'Reilly Media, Prentice Hall Professional, Addison-Wesley Professional, Microsoft Press, Sams, Que, Peachpit Press, Focal Press, Cisco Press, John Wiley & Sons, Syngress, Morgan Kaufmann, IBM Redbooks, Packt, Adobe Press, FT Press, Apress, Manning, New Riders, McGraw-Hill, Jones & Bartlett, Course Technology, and hundreds [more](#). For more information about Safari Books Online, please visit us [online](#).

How to Contact Us

Please address comments and questions concerning this book to the publisher:

Make:
1005 Gravenstein Highway North
Sebastopol, CA 95472
800-998-9938 (in the United States or Canada)
707-829-0515 (international or local)
707-829-0104 (fax)

Make: unites, inspires, informs, and entertains a growing community of resourceful people who undertake amazing projects in their backyards, basements, and garages. Make: celebrates your right to tweak, hack, and bend any technology to your will. The Make: audience continues to be a growing culture and community that believes in bettering ourselves, our environment, our educational system—our entire world. This is much more than an audience; it's a worldwide movement that Make: is leading—we call it the Maker Movement.

For more information about Make:, visit us online:

Make: magazine: <http://makezine.com/magazine/>
Maker Faire: <http://makerfaire.com>
Makezine.com: <http://makezine.com>
Maker Shed: <http://makershed.com>

We have a web page for this book, where we list errata, examples, and any additional information. You can access this page at:

<http://shop.oreilly.com/product/0636920031598.do>

To comment or ask technical questions about this book, send email to:

bookquestions@oreilly.com

Acknowledgments

I would like to thank Limor “Ladyada” Fried and Phillip Torrone of Adafruit Industries for the creative environment they have nurtured for Makers. Their encouragement and Adafruit’s content donations are the foundation of the book. Adafruit’s Frank Zhao and Phillip Burgess have built exquisite code and projects; their work, along with that of Adafruit contributors Rick Winscot and Bill Earl, has been incorporated with their permission and my thanks.

Thanks to the Maker Media team of Brian Jepson, Frank Teng, and Emma Dvorak, who guided the book’s production.

Finally, thanks to Kate and Laura, who listened when presented with science fact and fiction. To Traci, your support and encouragement, across time and space, continues to make possible my many endeavors—my love, always.

1/Introducing Trinket

The Arduino has revolutionized the use of microcontrollers—programmable electronics—in the last several years, providing easy-to-use hardware and software at a reasonable price point. The often-cited Internet of Things has grown from this ubiquity of easy-to-use programmable electronics, sensors, and communications.

One of the few disappointments that typically comes after building a permanent project is, “I used my Uno in my project, and now I no longer have my \$30 board.” That, and the fact that many projects do not require all the horsepower and connectivity an Arduino Uno or larger board offers.

This “bigger is not always best” situation offered an opportunity to Adafruit Industries, a small company based in New York City. Specializing in innovative open source hardware, Adafruit has grown to become a premier supplier to hobbyists and industry. *Entrepreneur* magazine named Adafruit founder Limor “Ladyada” Fried as Entrepreneur of the Year for 2012, and she has been featured in *WIRED Magazine*, *Popular Mechanics*, and other publications.



Ladyada has an uncanny ability to look at the needs of customers and personally oversee the design of product solutions. The need for an inexpensive microcontroller that can be built into projects (without guilt) led to her introduction of the Trinket.

Trinket Versus Arduino Uno

As many people are familiar, at least in part, with the Arduino Uno, a comparison may help (see [Figure 1-1](#)).

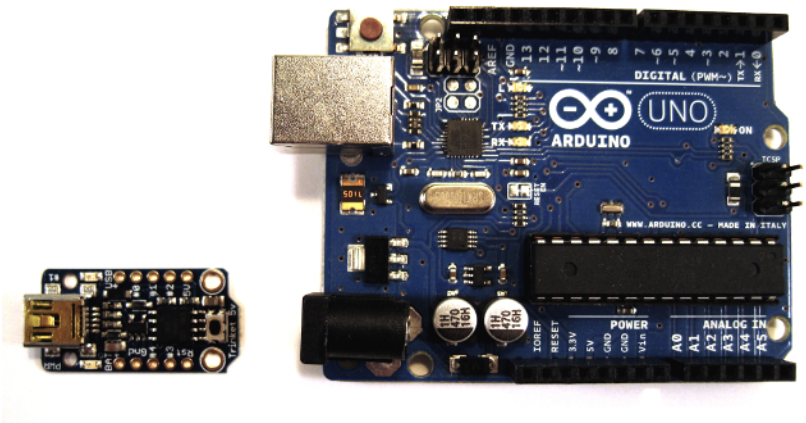

Figure 1-1. The Adafruit Trinket (left) and the Arduino Uno (right)

[Table 1-1](#) compares the features of each.

Table 1-1. Trinket and Uno feature comparison

	Adafruit Trinket	Arduino Uno
Pins (digital/analog)	5/3 (shared)	13/6
Pulse width modulated pins	3	5
Pin voltage	3.3 or 5 volts	5 volts
Memory (flash/RAM/EEPROM)	8KB/512 bytes/512 bytes	32KB/2,048 bytes/1,024 bytes
Size (mm)	1.2 × 0.6 × 0.2 inch/31 × 15.5 × 5	2.96 × 2.1 × 0.59 inches/75.14 × 53.51 × 15.08
Approximate cost	\$6.95	\$29.95

Using Trinket

Many projects do not require the size, power, and capabilities of larger Arduino compatibles. Here are some categories of projects where the Trinket may be a good choice:

Wearables

Wearables are a rapidly growing use for electronics. With its small size and low power requirements, the Trinket is being used in a growing number of clothing and body wear projects.

Sensing

The Internet of Things is composed of many small smart sensors communicating information about the world around us. The Trinket is perfect for attaching a wide variety of sensors and displaying or communicating sensor status.

Tiny projects

The Trinket is well suited for any use where programmability is desired in a small package. Very small robotics projects can be made with a Trinket.

Lights and display

Coupled with light-emitting diodes (LEDs), the Trinket is a great choice for DIY lighting projects. Used with smart red-green-blue (RGB) LEDs, a Trinket can perform complex light animations. Adafruit's smart RGB LEDs, *NeoPixels*, are controlled with only one data pin. You can drive LED and character displays with only two pins.

New uses for the Trinket appear regularly on Internet project sites including [Instructables](#), Google+, and the Adafruit [blog](#), and [forums](#).

The ATtiny85 Microcontroller

At the heart of the Trinket is the ATtiny85 microcontroller ([Figure 1-2](#)), produced by Atmel Corporation. Despite having only eight pins in a tiny package, this controller provides the functionality of traditionally larger processors.

The ATtiny85 was introduced by Atmel as an extremely small controller on the outside with many of the features of larger processors inside.

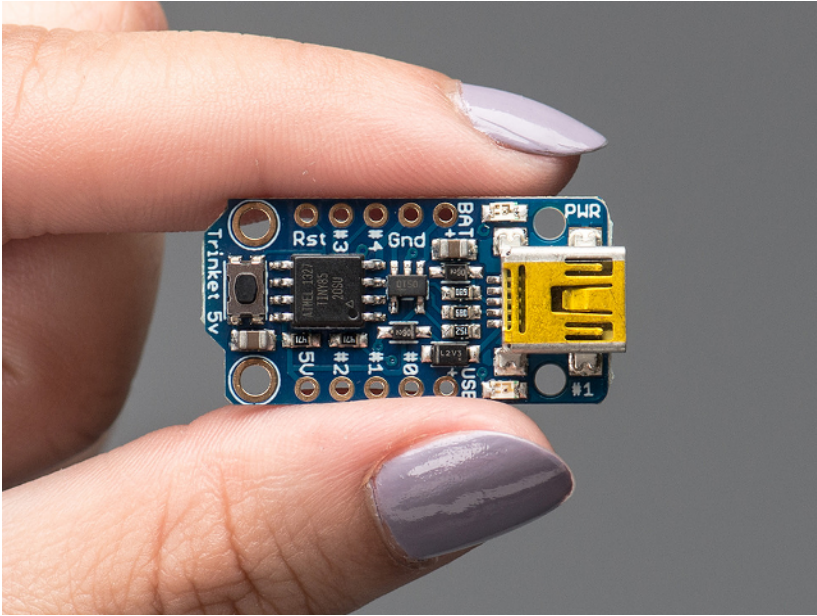

Figure 1-2. The ATtiny85 (the small black square on the Trinket)

Memory

As you can see in [Figure 1-3](#), this chip has three different types of memory. The ATtiny85 has 8,192 bytes of flash memory for programs. The Trinket contains *bootloader* code, which occupies part of this. The bootloader assists in loading user programs from the universal serial bus (USB) port. Adafruit has developed a custom bootloader based on [the V-USB project](#). With the bootloader in flash memory, there is approximately 5,130 bytes of program memory available for user programs. Random access memory (RAM) is used for program variables. The ATtiny85 has 512 bytes of RAM, which seems like a minuscule amount compared to the 4 GB on a typical laptop, but in practice this is often more than enough for many programs.

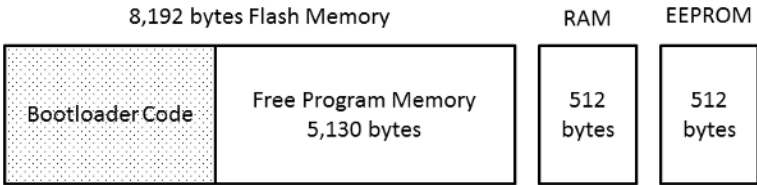

Figure 1-3. The Trinket memory map

Finally, the chip also contains 512 bytes of *electrically erasable programmable read-only memory* (EEPROM). You can use this memory to store user data that remains even after the Trinket is powered off. This is useful to save data such as setup information, state data, or critical readings. This memory can also be useful for storing static information such as character strings a program might use, which otherwise would occupy precious program flash memory or RAM. However, programmers must weigh the benefits of using EEPROM against the additional code the compiler may add to manipulate data. Most programs do not use EEPROM.

Connectivity

The ATtiny85 chip uses only six pins for input and output, with two pins for power and ground. Atmel engineers cleverly assigned multiple types of functionality to each pin, as shown in [Figure 1-4](#).

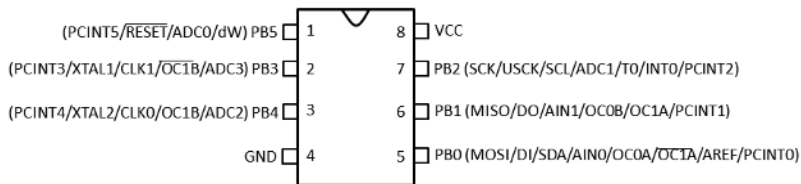

Figure 1-4. The multiple functions on the ATtiny85 pins

In the design of the Trinket, Adafruit exposes much of the chip functionality. The designers added the ability to communicate over the USB serial port, as well as status lights and a reset button. [Figure 1-5](#) shows the Trinket 5V and the functionality onboard. The pins' functions are listed in [Table 1-2](#).

Data is exchanged via the pins marked #0, #1, #2, #3, and #4. The sixth data pin (PB5) is permanently connected to the reset button and RST input; it cannot be used as an input/output pin due to how the Trinket is configured.

The Trinket has a power input pin, usually for a battery. There are also two voltage output pins: one for USB power (if connected to a computer) and a regulated power output tied to the battery input with a maximum power draw of 150 milliamps (mA).

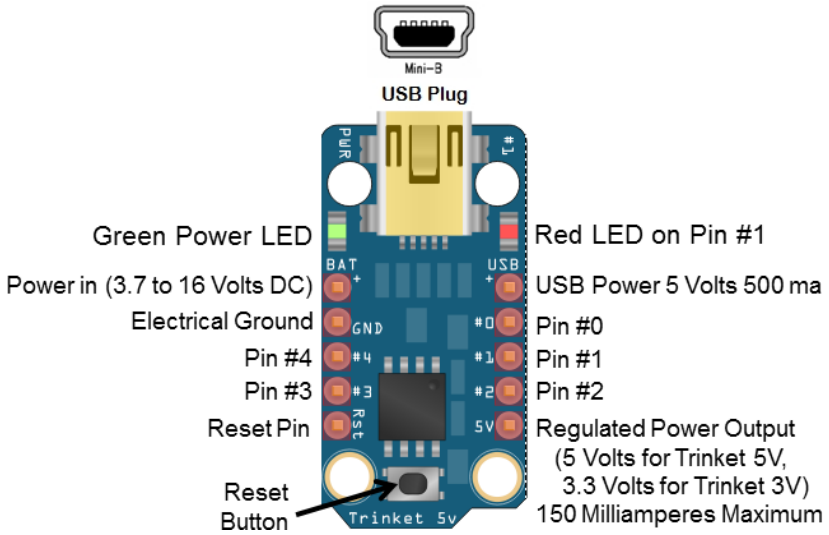

Figure 1-5. *Trinket connections*

Table 1-2. *Trinket pin use*

Trinket pin	ATtiny85 function	digitalRead digitalWrite	Analog analogRead	Pulse width modulation (PWM) analogWrite	I ² C (TWI)	SPI	Pin is shared with	
#0	PB0	0		0	SDA	MOSI		
#1	PB1	1		1		MISO	Red LED	
#2	PB2	2	1		SCK	SCLK		
#3	PB3	3	3				USB D-	
#4	PB4	4	2	With custom code			USB D+	
RST	PB5	Connecting this pin to ground/GND resets the processor, similar to the reset button						Reset button
USB+	Provides 5 volts at 500 milliamperes when a USB plug is connected to the Trinket USB plug							USB power
BAT+	Battery power in (if not powered by USB), 3.7 to 16 volts (both Trinkets)							
GND	Electrical ground connection (negative power lead)							
3V or 5V	Provides 3.3 volts (Trinket 3V) or 5 volts (Trinket 5V) at 150 milliamperes							

Of particular note is that the ATtiny85 does not have native USB communication capability onboard. Adafruit wanted to develop a bootloader with

the company's own USB identification. This allowed the design to use an existing computer driver Adafruit previously developed, which had the benefit of not requiring changes to the program that the Arduino software uses to transfer compiled code to the Trinket (avrdude).

Three Volts or Five Volts?

The Trinket comes in two versions. One operates at 5 volts direct current (DC), the other at 3.3 volts DC. The functionality of each is nearly identical. The 5-volt version can run from USB power or from an input voltage of 5 to 16 volts. The 3.3-volt version can run from USB power or an input voltage of 3.3 to 16 volts DC.

This provides a great deal of flexibility in powering a Trinket. A Trinket may be powered from a wall-mounted DC power supply (like a cell phone charger-type supply), of course. But it is also very suitable to being powered from a wide range of batteries. This includes batteries such as a single 3.7-volt lithium-polymer (LiPo) battery, three 1.5-volt batteries in series (4.5 volts), four batteries in series (6 volts for regular cells, 4.8 volts for rechargeables), or even a 9-volt battery (although a 9-volt may not provide current for a long time). The size of the batteries (the ampere-hour rating of the LiPo, or whether you use AAA, AA, C, or D cells) determines how long a circuit may last.



Supply Voltage Designation

V_{CC} or VCC is one of the electronic designations for a project's voltage level. For this book, V_{CC} will generally be 5 volts for projects using a Trinket 5V and 3.3 volts for projects using a Trinket 3V or a Gemma (see ["The Adafruit Gemma" on page 8](#)).

The 3.3-volt version may be preferable when running off a 3.7-volt LiPo rechargeable battery. Sensors that operate on a 3.3-volt signal level are easier to use with a Trinket 3V. The only limitation the Trinket 3V has compared to the Trinket 5V is that the Trinket 3V can run at a clock speed of only 8 megahertz (MHz).

Many digital circuits operate at a signal level of 5 volts. Hooking a 5-volt circuit to a 3.3-volt input pin could damage the Trinket 3V's ATtiny85, so for projects that must use 5-volt signal levels, the Trinket 5V is the better choice. The Trinket 5V can run at a clock speed of 8 MHz or, via a software switch, at 16 MHz. Both the Trinket 5V and the Trinket 3V are used in projects in this book. You'll probably want to buy one of each for starters.

The Adafruit Gemma

The Adafruit Gemma (Figure 1-6) is a mini-microcontroller platform designed specifically for wearable projects. It contains the same ATtiny85 processor and bootloader as the Trinket 3V. Besides the easy-to-sew shape, the main difference is the addition of a premounted JST connector (white in the photo) to directly connect a LiPo battery. The Gemma does not expose data pins #3 and #4, as the Trinket does. More information on Gemma may be found at <http://learn.adafruit.com/introducing-gemma>.

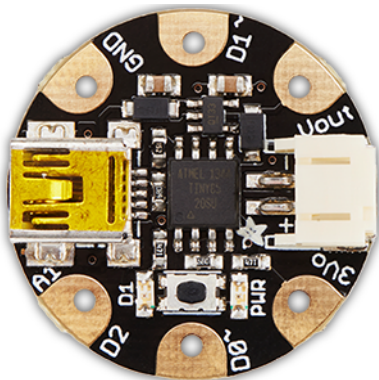

Figure 1-6. *The Adafruit Gemma*

If you need more than three data pins for a small project, the Trinket is a better choice than the Gemma. The Gemma comes only in a 3.3-volt version, whereas the Trinket has 3.3- and 5-volt options. Also, the Trinket 5V may be clocked to 16 MHz, twice as much as the Trinket 3V and Gemma. Code-wise, the Trinket and Gemma are identical.