



InGaP HBT GAIN BLOCK MMIC AMPLIFIER, 0.7 -2.8 GHz

Typical Applications

The HMC789ST89E is ideal for:

- Cellular/4G
- Fixed Wireless & WLAN
- CATV, Cable Modem & DBS
- Microwave Radio & Test Equipment
- IF & RF Applications

Features

- High Output IP3: +42 dBm
- High Output P1dB: +25 dBm
- High Gain: 18 dB
- Single Supply: +5V
- 45% PAE @ +25 dBm Pout
- Industry Standard SOT89 Package

Functional Diagram

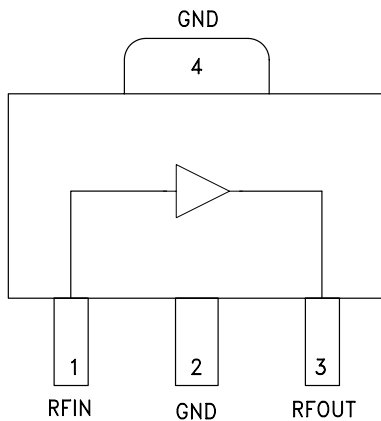

General Description

The HMC789ST89E is a high linearity GaAs InGaP HBT gain block MMIC operating from 0.7 to 2.8 GHz and packaged in an industry standard SOT89 package. Utilizing a minimum number of external components and a single +5V supply, the amplifier output IP3 can be optimized to +45 dBm. The high output IP3 and high gain make the HMC789ST89E ideal for use in PA driver & pre-driver applications in Cellular/4G and Fixed Wireless.

Electrical Specifications, $T_A = +25^\circ\text{C}$, $V_S = +5\text{V}$ [1]

Parameter	Min.	Typ.	Max.	Min.	Typ.	Max.	Min.	Typ.	Max.	Units
Frequency Range	810 - 960			1710 - 1990			2420 - 2700			MHz
Gain	17	18		12	13.5		10	11		dB
Gain Variation Over Temperature		0.01			0.01			0.01		dB / °C
Input Return Loss		12			12			10		dB
Output Return Loss		20			15			10		dB
Output Power for 1dB Compression (P1dB)	21	23.5		23	25		22	24		dBm
Saturated Output Power (Psat)		25.5			27			26		dBm
Output Third Order Intercept (IP3) [2]		42			42			42		dBm
Noise Figure		3.8			3.8			3.8		dB
Supply Current (Icq)		125	150		125	150		125	150	mA

[1] Specifications and data reflect HMC789ST89E measured using the respective application circuits for each designated frequency band found herein. Contact the HMC Applications Group for assistance in optimizing performance for your application.

[2] Two-tone output power of +10 dBm per tone, 1 MHz spacing.

HMC789* PRODUCT PAGE QUICK LINKS

Last Content Update: 02/23/2017

COMPARABLE PARTS

View a parametric search of comparable parts.

EVALUATION KITS

- HMC789ST89E Evaluation Board

DOCUMENTATION

Application Notes

- AN-1363: Meeting Biasing Requirements of Externally Biased RF/Microwave Amplifiers with Active Bias Controllers

Data Sheet

- HMC789 Data Sheet

TOOLS AND SIMULATIONS

- HMC789 S-Parameter

REFERENCE MATERIALS

Quality Documentation

- Package/Assembly Qualification Test Report: 3 Lead Plastic SOT89 Package (QTR: 10002 REV: 02)
- Semiconductor Qualification Test Report: GaAs HBT-E (QTR: 2013-00271)

DESIGN RESOURCES

- HMC789 Material Declaration
- PCN-PDN Information
- Quality And Reliability
- Symbols and Footprints

DISCUSSIONS

View all HMC789 EngineerZone Discussions.

SAMPLE AND BUY

Visit the product page to see pricing options.

TECHNICAL SUPPORT

Submit a technical question or find your regional support number.

DOCUMENT FEEDBACK

Submit feedback for this data sheet.



**InGaP HBT GAIN BLOCK MMIC
AMPLIFIER, 0.7 -2.8 GHz**

**Broadband Gain &
Return Loss @ 900 MHz**

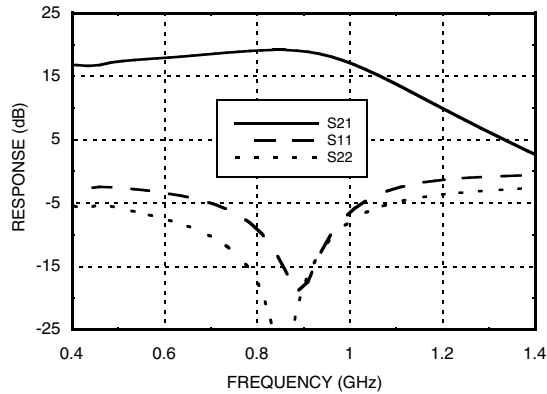

Gain vs. Temperature @ 900 MHz

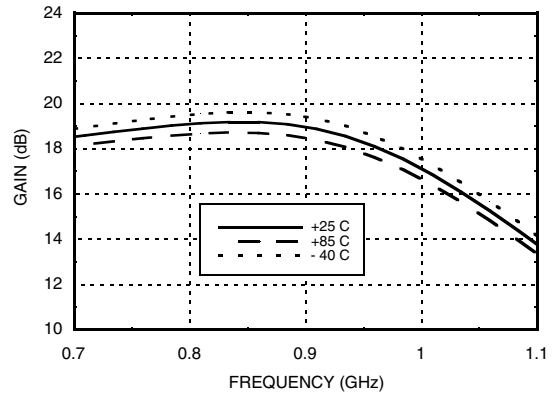

**Input Return Loss vs.
Temperature @ 900 MHz**

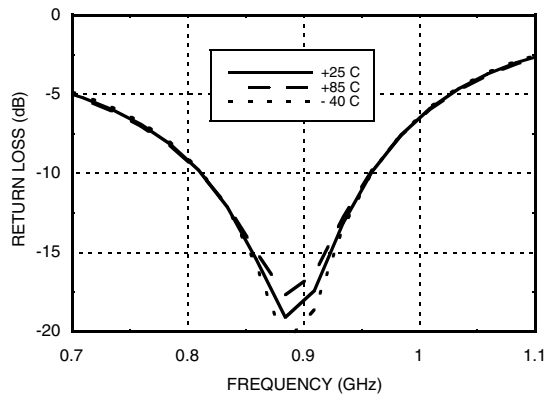

**Output Return Loss vs.
Temperature @ 900 MHz**

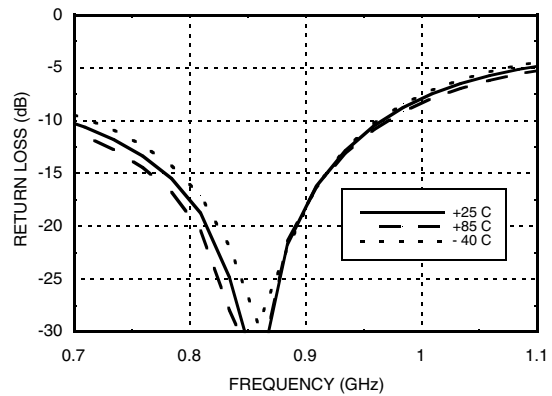

P1dB vs. Temperature @ 900 MHz

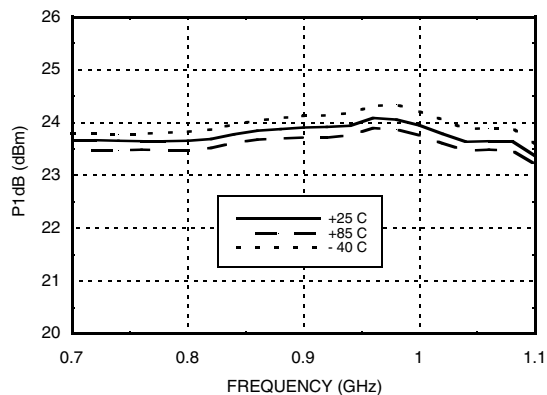

Psat vs. Temperature @ 900 MHz

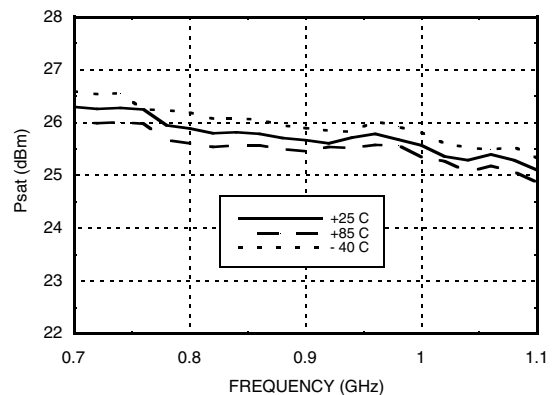

Information furnished by Analog Devices is believed to be accurate and reliable. However, no responsibility is assumed by Analog Devices for its use, nor for any infringements of patents or other rights of third parties that may result from its use. Specifications subject to change without notice. No license is granted by implication or otherwise under any patent or patent rights of Analog Devices. Trademarks and registered trademarks are the property of their respective owners.

For price, delivery, and to place orders: Analog Devices, Inc., One Technology Way, P.O. Box 9106, Norwood, MA 02062-9106 Phone: 781-329-4700 • Order online at www.analog.com Application Support: Phone: 1-800-ANALOG-D



**InGaP HBT GAIN BLOCK MMIC
AMPLIFIER, 0.7 -2.8 GHz**

AMPLIFIERS - DRIVER & GAIN BLOCK - SMT

**Output IP3 vs. Temperature @ 900 MHz
Pout = 10 dBm Each Tone**

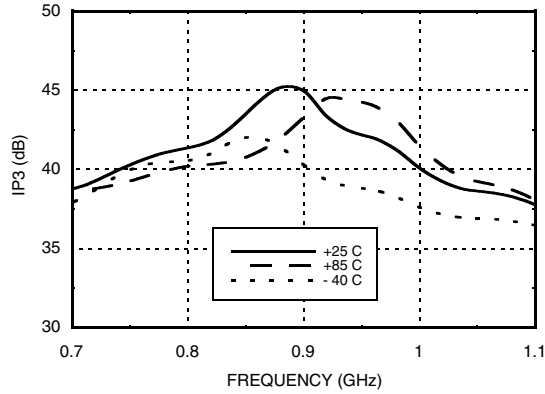

**Output IP3 vs.
Output Power @ 900 MHz**

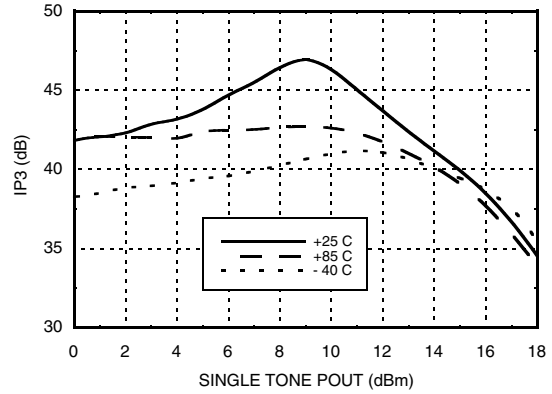

Noise Figure vs. Temperature @ 900 MHz

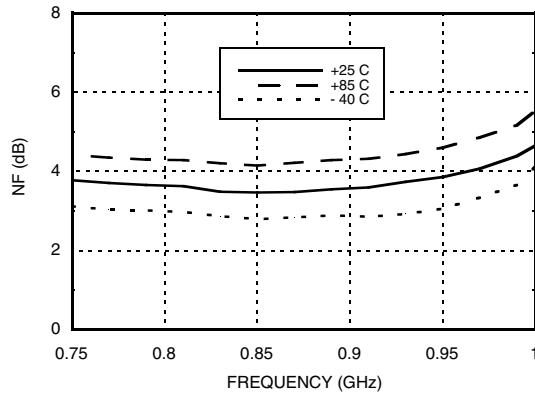

**Reverse Isolation vs.
Temperature @ 900 MHz**

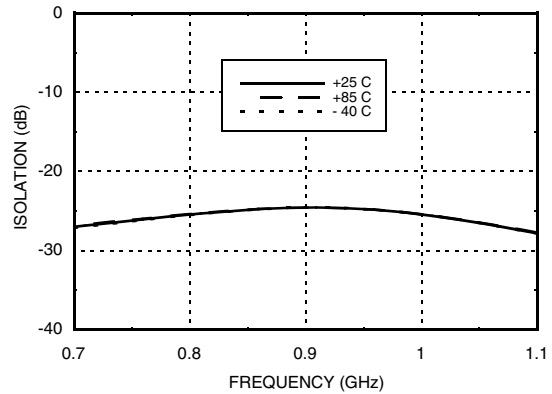

**Gain, Power & IP3 vs.
Supply Voltage @ 900 MHz**

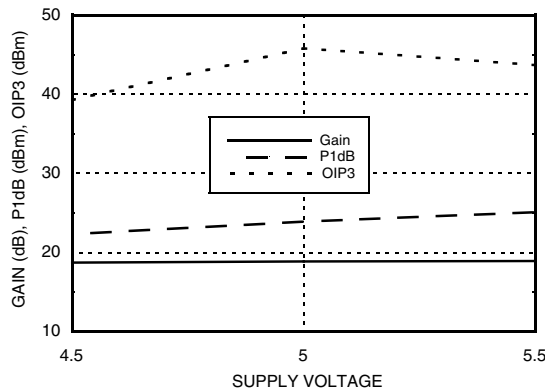

Power Compression @ 900 MHz

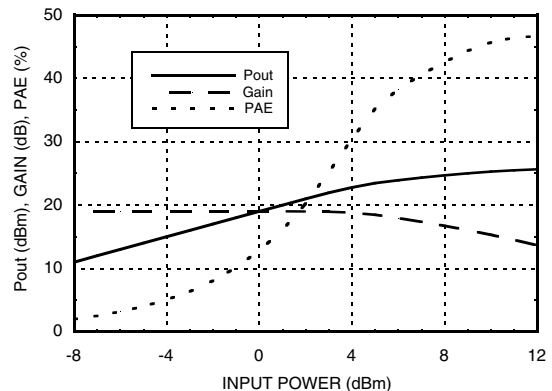

Information furnished by Analog Devices is believed to be accurate and reliable. However, no responsibility is assumed by Analog Devices for its use, nor for any infringements of patents or other rights of third parties that may result from its use. Specifications subject to change without notice. No license is granted by implication or otherwise under any patent or patent rights of Analog Devices. Trademarks and registered trademarks are the property of their respective owners.

For price, delivery, and to place orders: Analog Devices, Inc., One Technology Way, P.O. Box 9106, Norwood, MA 02062-9106 Phone: 781-329-4700 • Order online at www.analog.com Application Support: Phone: 1-800-ANALOG-D



**InGaP HBT GAIN BLOCK MMIC
AMPLIFIER, 0.7 -2.8 GHz**

**ACPR vs. Supply Voltage @ 880 MHz
CDMA IS95, 9 Channels Forward**

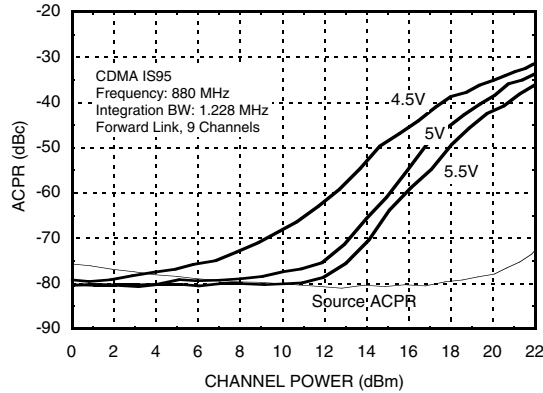

**Broadband Gain &
Return Loss @ 1900 MHz**

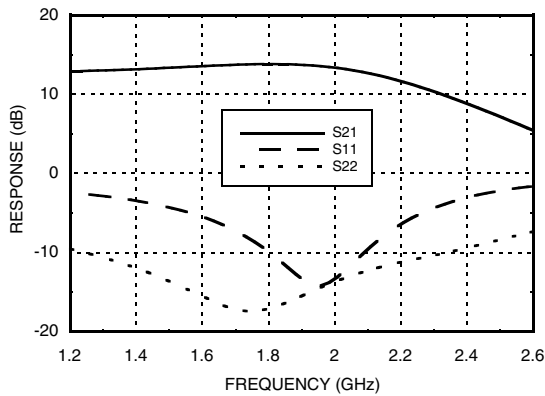

Gain vs. Temperature @ 1900 MHz

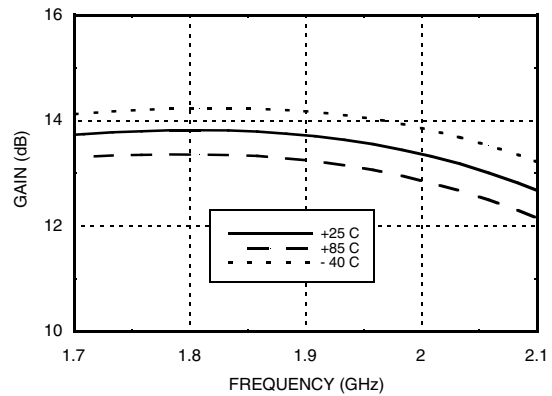

**Input Return Loss vs.
Temperature @ 1900 MHz**

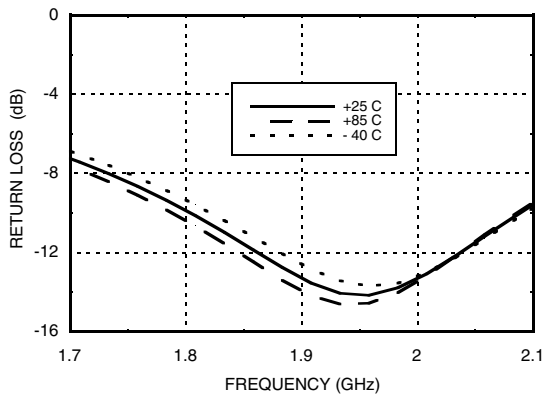

**Output Return Loss vs.
Temperature @ 1900 MHz**

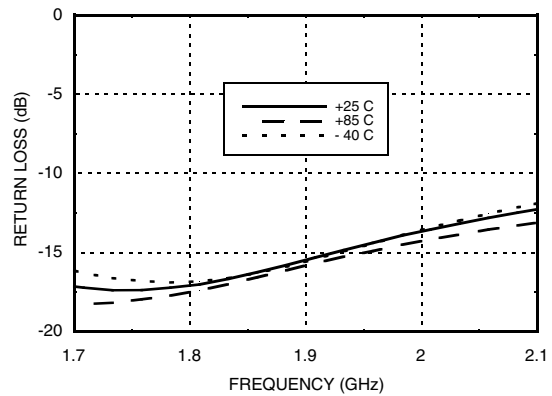

Information furnished by Analog Devices is believed to be accurate and reliable. However, no responsibility is assumed by Analog Devices for its use, nor for any infringements of patents or other rights of third parties that may result from its use. Specifications subject to change without notice. No license is granted by implication or otherwise under any patent or patent rights of Analog Devices. Trademarks and registered trademarks are the property of their respective owners.

For price, delivery, and to place orders: Analog Devices, Inc., One Technology Way, P.O. Box 9106, Norwood, MA 02062-9106 Phone: 781-329-4700 • Order online at www.analog.com Application Support: Phone: 1-800-ANALOG-D



HMC789ST89E

InGaP HBT GAIN BLOCK MMIC AMPLIFIER, 0.7 -2.8 GHz

AMPLIFIERS - DRIVER & GAIN BLOCK - SMT

P1dB vs. Temperature @ 1900 MHz

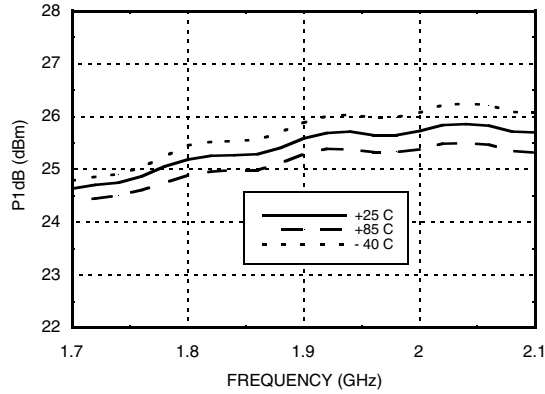

Psat vs. Temperature @ 1900 MHz

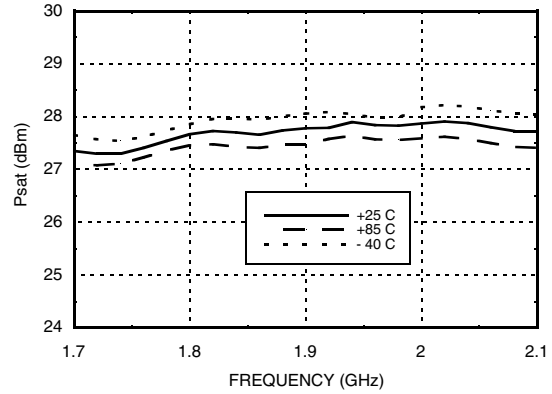

Output IP3 vs. Temperature @ 1900 MHz

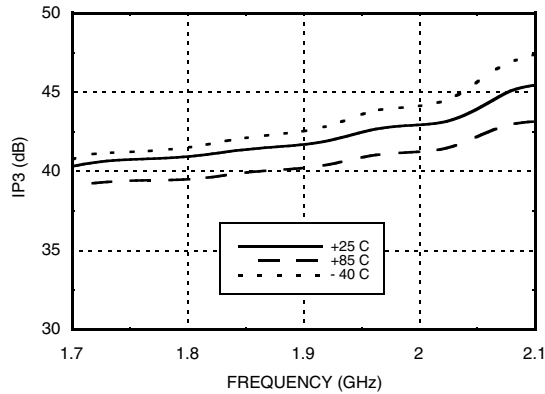

Output IP3 vs. Output Power @ 1900 MHz

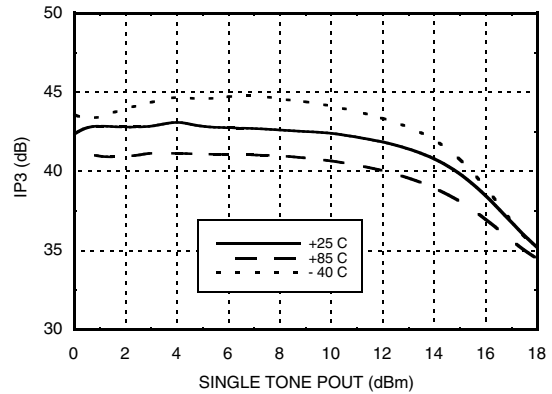

Noise Figure vs. Temperature @ 1900 MHz

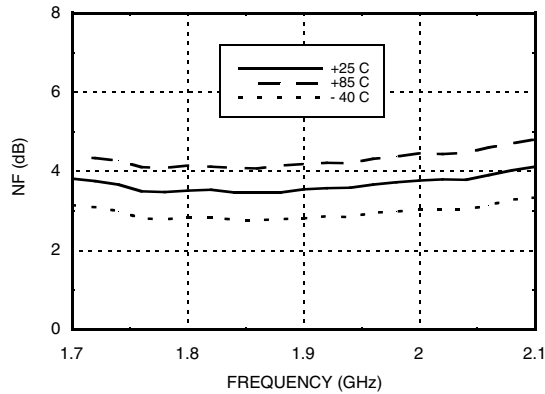

Reverse Isolation vs. Temperature @ 1900 MHz

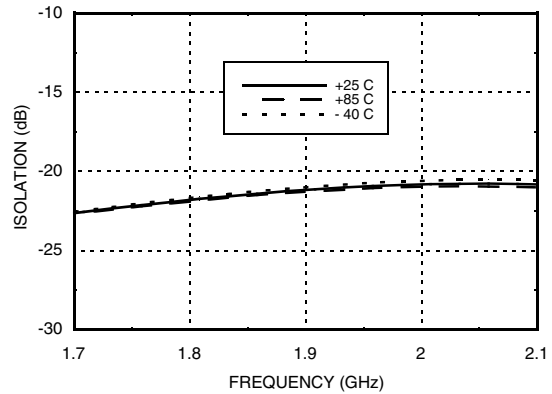

Information furnished by Analog Devices is believed to be accurate and reliable. However, no responsibility is assumed by Analog Devices for its use, nor for any infringements of patents or other rights of third parties that may result from its use. Specifications subject to change without notice. No license is granted by implication or otherwise under any patent or patent rights of Analog Devices. Trademarks and registered trademarks are the property of their respective owners.

For price, delivery, and to place orders: Analog Devices, Inc., One Technology Way, P.O. Box 9106, Norwood, MA 02062-9106 Phone: 781-329-4700 • Order online at www.analog.com Application Support: Phone: 1-800-ANALOG-D



InGaP HBT GAIN BLOCK MMIC AMPLIFIER, 0.7 -2.8 GHz

Gain, Power & IP3 vs. Supply Voltage @ 1900 MHz

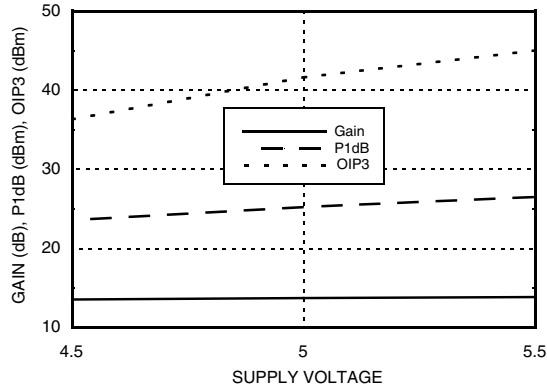

Power Compression @ 1900 MHz

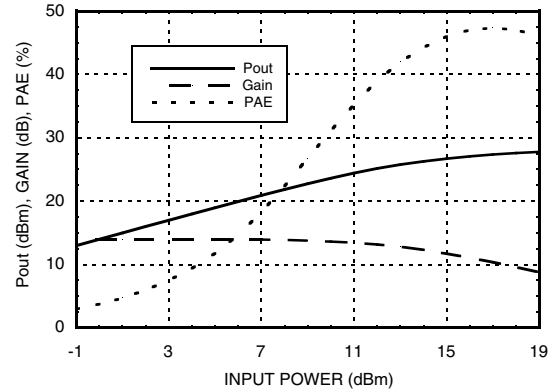

ACPR vs. Supply Voltage @ 1960 MHz CDMA 2000, 9 Channels Forward

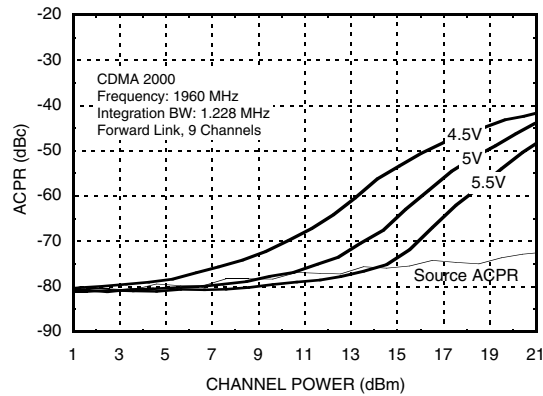

ACPR vs. Supply Voltage @ 2140 MHz W-CDMA, 64 DPCH

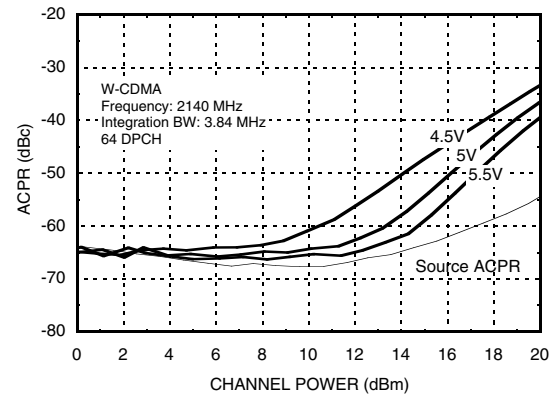

Broadband Gain & Return Loss @ 2600 MHz

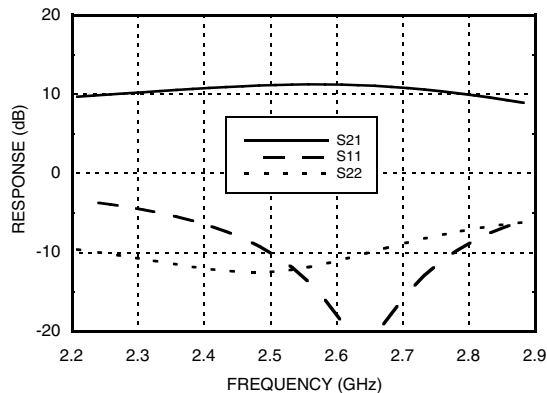

Gain vs. Temperature @ 2600 MHz

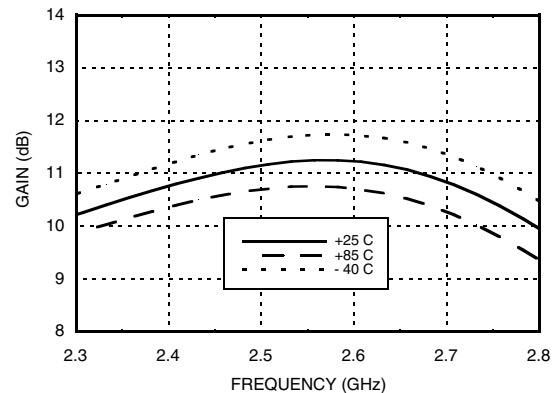

Information furnished by Analog Devices is believed to be accurate and reliable. However, no responsibility is assumed by Analog Devices for its use, nor for any infringements of patents or other rights of third parties that may result from its use. Specifications subject to change without notice. No license is granted by implication or otherwise under any patent or patent rights of Analog Devices. Trademarks and registered trademarks are the property of their respective owners.

For price, delivery, and to place orders: Analog Devices, Inc., One Technology Way, P.O. Box 9106, Norwood, MA 02062-9106 Phone: 781-329-4700 • Order online at www.analog.com Application Support: Phone: 1-800-ANALOG-D



**InGaP HBT GAIN BLOCK MMIC
AMPLIFIER, 0.7 -2.8 GHz**

**Input Return Loss vs.
Temperature @ 2600 MHz**

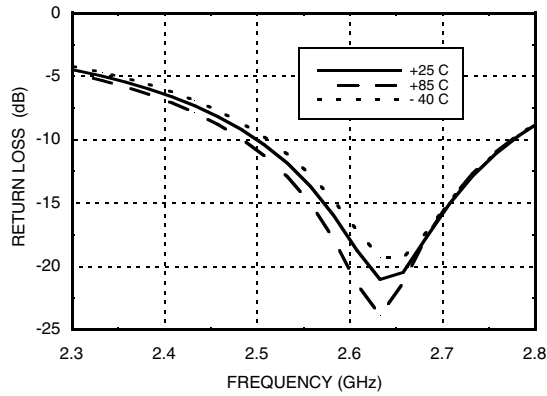

**Output Return Loss vs.
Temperature @ 2600 MHz**

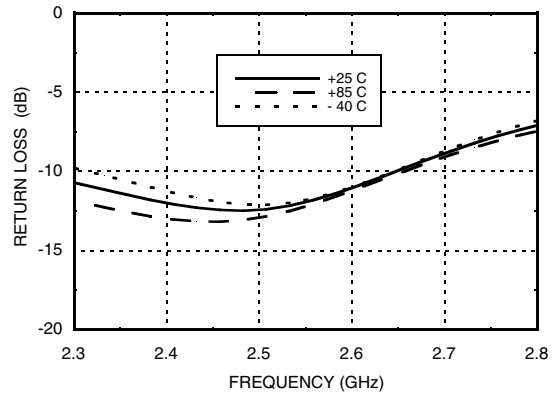

P1dB vs. Temperature @ 2600 MHz

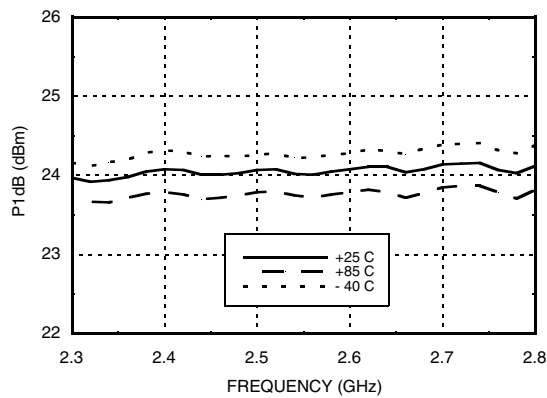

Psat vs. Temperature @ 2600 MHz

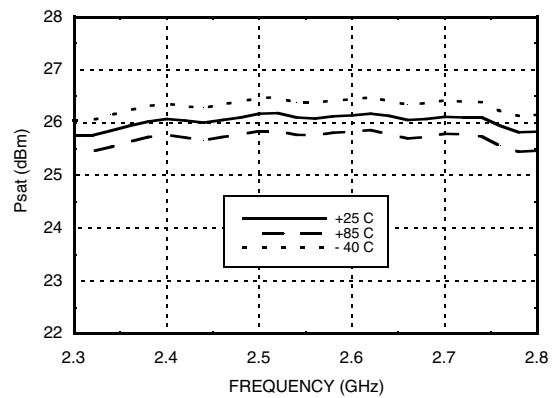

Output IP3 vs. Temperature @ 2600 MHz

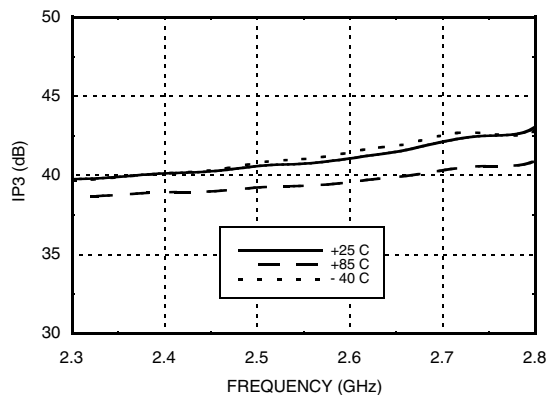

Output IP3 vs. Output Power @ 2600 MHz

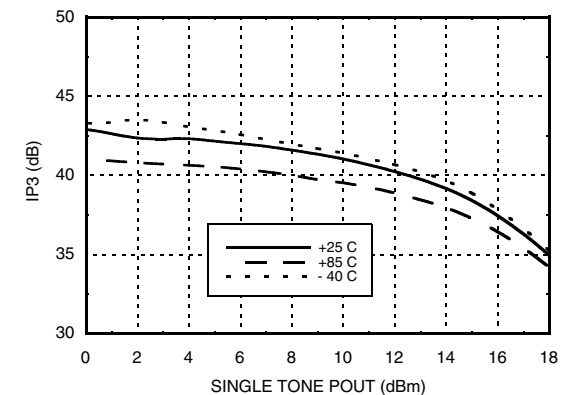

Information furnished by Analog Devices is believed to be accurate and reliable. However, no responsibility is assumed by Analog Devices for its use, nor for any infringements of patents or other rights of third parties that may result from its use. Specifications subject to change without notice. No license is granted by implication or otherwise under any patent or patent rights of Analog Devices. Trademarks and registered trademarks are the property of their respective owners.

For price, delivery, and to place orders: Analog Devices, Inc., One Technology Way, P.O. Box 9106, Norwood, MA 02062-9106 Phone: 781-329-4700 • Order online at www.analog.com Application Support: Phone: 1-800-ANALOG-D



**InGaP HBT GAIN BLOCK MMIC
AMPLIFIER, 0.7 -2.8 GHz**

Noise Figure vs. Temperature @ 2600 MHz

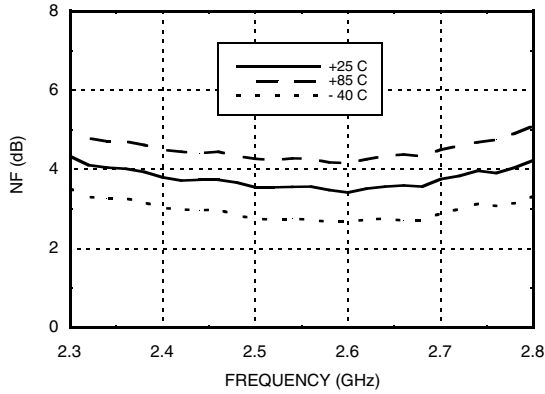

Reverse Isolation vs. Temperature @ 2600 MHz

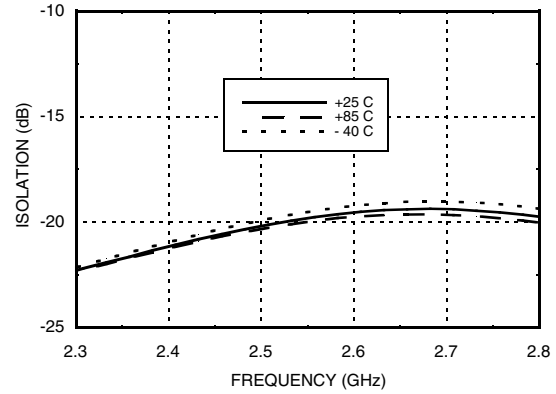

Gain, Power & IP3 vs. Supply Voltage @ 2600 MHz

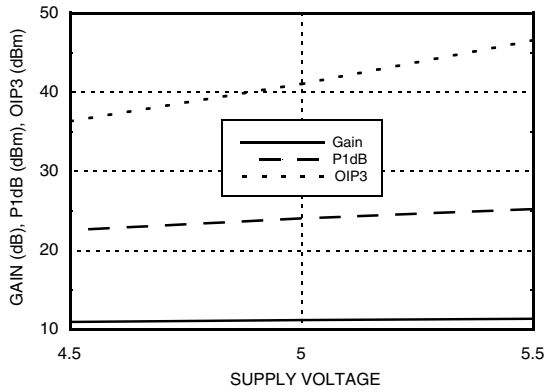

Power Compression @ 2600 MHz

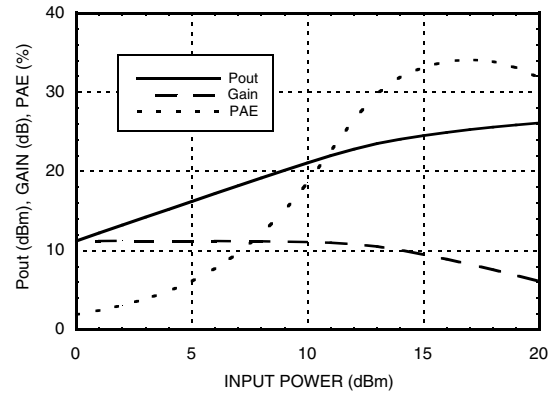





**InGaP HBT GAIN BLOCK MMIC
AMPLIFIER, 0.7 -2.8 GHz**
Absolute Maximum Ratings

Collector Bias Voltage (Vcc)	+6.0 V
RF Input Power (RFIN)(Vs +5Vdc)	+18 dBm
Junction Temperature	150 °C
Continuous P _{diss} (T = 85 °C) (derate 13.0 mW/°C above 85 °C)	0.85 W
Thermal Resistance (junction to ground paddle)	77 °C/W
Storage Temperature	-65 to +150 °C
Operating Temperature	-40 to +85 °C

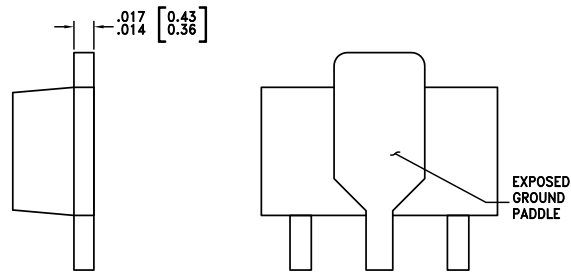
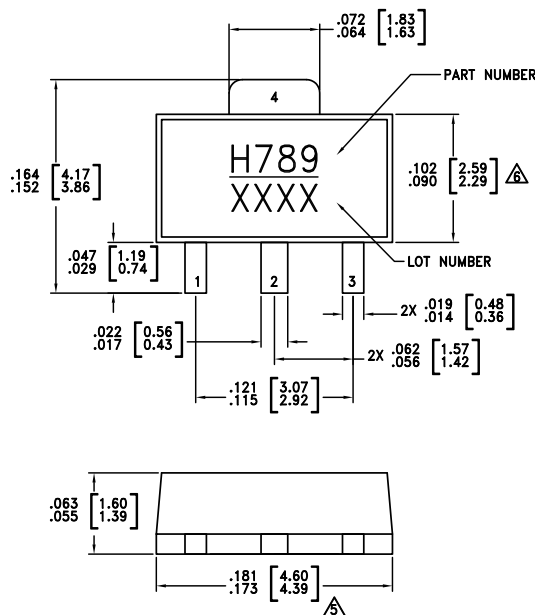

**ELECTROSTATIC SENSITIVE DEVICE
OBSERVE HANDLING PRECAUTIONS**

Outline Drawing

NOTES:

- PACKAGE BODY MATERIAL:
MOLDING COMPOUND MP-180S OR EQUIVALENT.
- LEAD MATERIAL: Cu w/ Ag SPOT PLATING.
- LEAD PLATING: 100% MATTE TIN.
- DIMENSIONS ARE IN INCHES [MILLIMETERS]
-  DIMENSION DOES NOT INCLUDE MOLDFLASH OF 0.15mm PER SIDE.
-  DIMENSION DOES NOT INCLUDE MOLDFLASH OF 0.25mm PER SIDE.
- ALL GROUND LEADS MUST BE SOLDERED TO PCB RF GROUND.



Package Information

Part Number	Package Body Material	Lead Finish	MSL Rating	Package Marking ^[1]
HMC789ST89E	RoHS-compliant Low Stress Injection Molded Plastic	100% matte Sn	MSL1 ^[2]	H789 XXXX

[1] 4-Digit lot number XXXX

[2] Max peak reflow temperature of 260 °C

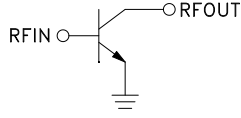
**InGaP HBT GAIN BLOCK MMIC
AMPLIFIER, 0.7 -2.8 GHz**
Pin Descriptions

Pin Number	Function	Description	Interface Schematic
1	RFIN	This pin is DC coupled. Off chip matching components are required. See Application Circuit herein.	
3	RFOUT	RF output and DC Bias input for the amplifier. Off chip matching components are required. See Application Circuit herein.	
2, 4	GND	These pins & package bottom must be connected to RF/DC ground.	

**InGaP HBT GAIN BLOCK MMIC
AMPLIFIER, 0.7 -2.8 GHz**
900 MHz Application Circuit

This circuit was used to specify the performance for 810-960 MHz operation. Contact the HMC Applications Group for assistance in optimizing performance for your application.

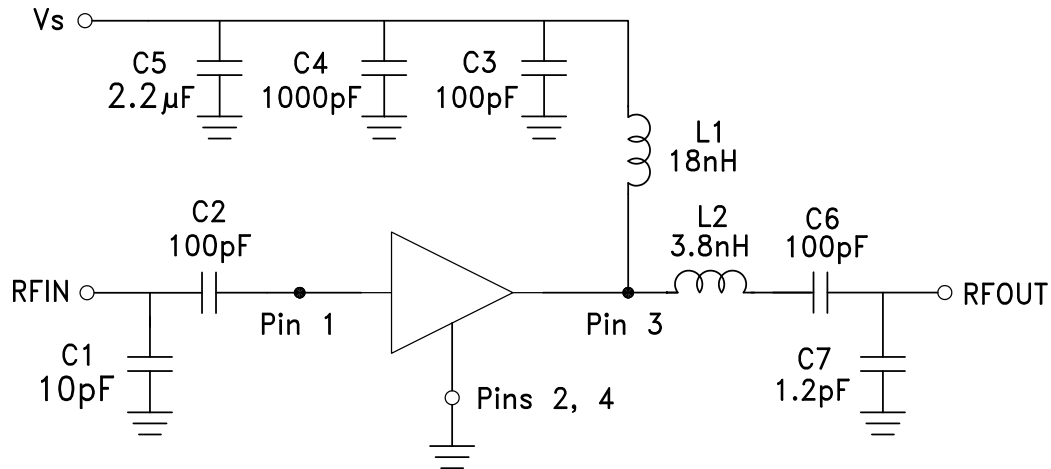

Recommended Component Values	
C1	10 pF
C2	100 pF
C3	100 pF
C4	1000 pF
C5	2.2 μF
C6	100 pF
C7	1.2 pF
L1	18 nH
L2	3.8 nH

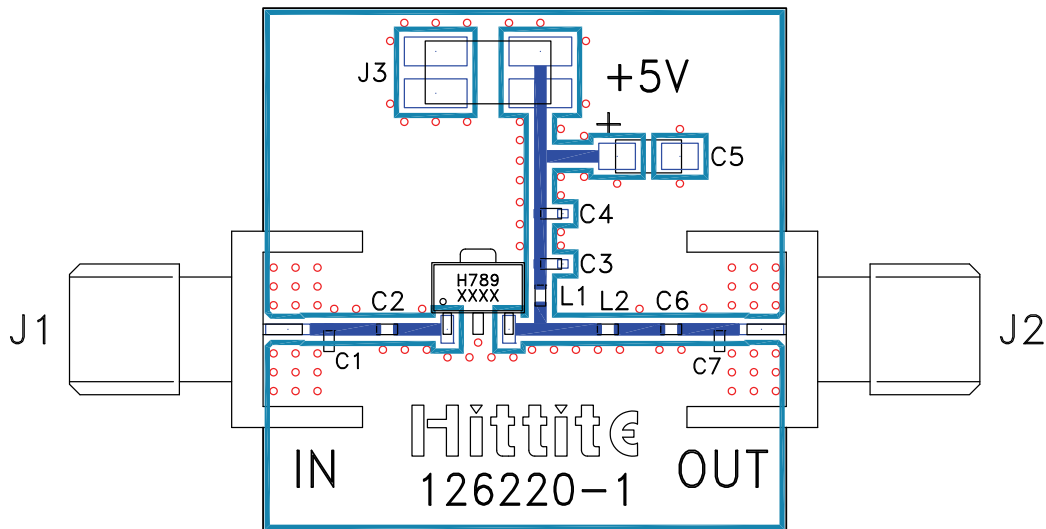
**InGaP HBT GAIN BLOCK MMIC
AMPLIFIER, 0.7 -2.8 GHz**
900 MHz Evaluation PCB

List of Materials for 900 MHz Evaluation PCB 126222 [1]

Item	Description
J1 - J2	PCB Mount SMA Connector
J3	2 mm DC Header
C1	10 pF Capacitor, 0402 Pkg.
C2	100 pF Capacitor, 0402 Pkg.
C3	100 pF Capacitor, 0402 Pkg.
C4	1000 pF Capacitor, 0402 Pkg.
C5	2.2 μ F Capacitor, Tantalum
C6	100 pF Capacitor, 0402 Pkg.
C7	1.2 pF Capacitor, 0402 Pkg.
L1	18 nH Inductor, 0402 Pkg.
L2	3.8 nH Inductor, 0402 Pkg.
U1	HMC789ST89E Linear Amplifier
PCB [2]	126220 Evaluation PCB

[1] Reference this number when ordering complete evaluation PCB

[2] Circuit Board Material: FR4

The circuit board used in this application should use RF circuit design techniques. Signal lines should have 50 Ohm impedance while the package ground leads and exposed paddle should be connected directly to the ground plane similar to that shown. A sufficient number of via holes should be used to connect the top and bottom ground planes. The evaluation board should be mounted to an appropriate heat sink. The evaluation circuit board shown is available from Hittite upon request.



**InGaP HBT GAIN BLOCK MMIC
AMPLIFIER, 0.7 -2.8 GHz**

1900 MHz Application Circuit

This circuit was used to specify the performance for 1710-1990 MHz operation. Contact the HMC Applications Group for assistance in optimizing performance for your application.

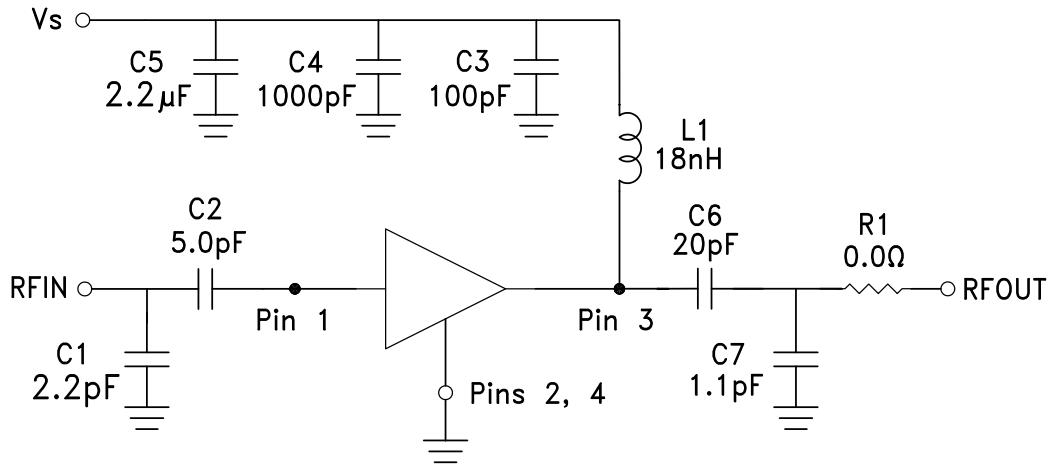

Recommended Component Values	
C1	2.2 pF
C2	5.0 pF
C3	100 pF
C4	1000 pF
C5	2.2 μF
C6	20 pF
C7	1.1 pF
L1	20 nH
R1	0.0 Ohm

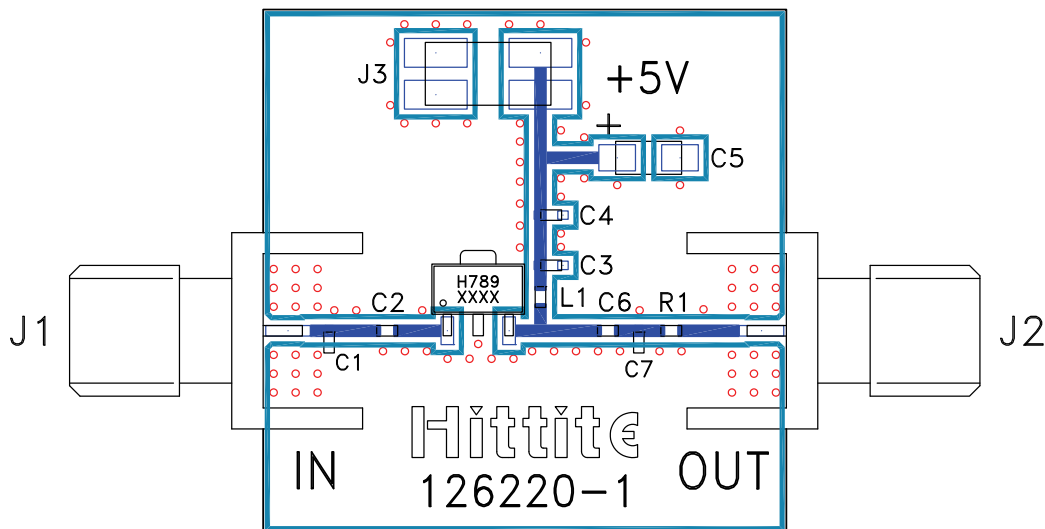
**InGaP HBT GAIN BLOCK MMIC
AMPLIFIER, 0.7 -2.8 GHz**
1900 MHz Evaluation PCB

List of Materials for 1900 MHz Evaluation PCB 126223 [1]

Item	Description
J1 - J2	PCB Mount SMA Connector
J3	2 mm DC Header
C1	2.2 pF Capacitor, 0402 Pkg.
C2	5.0 pF Capacitor, 0402 Pkg.
C3	100 pF Capacitor, 0402 Pkg.
C4	1000 pF Capacitor, 0402 Pkg.
C5	2.2 μF Capacitor, Tantalum
C6	20 pF Capacitor, 0402 Pkg.
C7	1.1 pF Capacitor, 0402 Pkg.
L1	18 nH Inductor, 0402 Pkg.
R1	0.0 Ohm Resistor, 0402 Pkg.
U1	HMC789ST89E Linear Amplifier
PCB [2]	126220 Evaluation PCB

[1] Reference this number when ordering complete evaluation PCB

[2] Circuit Board Material: FR4

The circuit board used in this application should use RF circuit design techniques. Signal lines should have 50 Ohm impedance while the package ground leads and exposed paddle should be connected directly to the ground plane similar to that shown. A sufficient number of via holes should be used to connect the top and bottom ground planes. The evaluation board should be mounted to an appropriate heat sink. The evaluation circuit board shown is available from Hittite upon request.



InGaP HBT GAIN BLOCK MMIC AMPLIFIER, 0.7 -2.8 GHz

2600 MHz Application Circuit

This circuit was used to specify the performance for 2420-2700 MHz operation. Contact the HMC Applications Group for assistance in optimizing performance for your application.

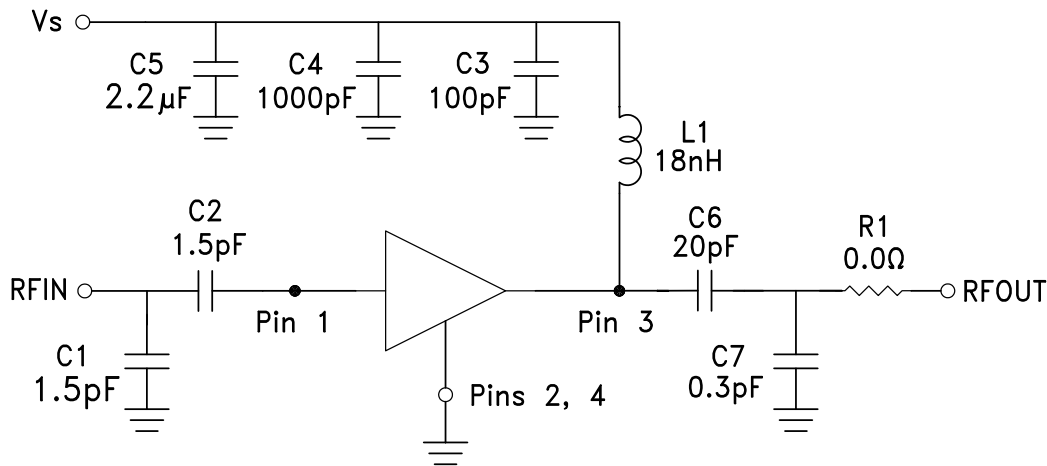

Recommended Component Values	
C1	1.5 pF
C2	1.5 pF
C3	100 pF
C4	1000 pF
C5	2.2 μF
C6	20 pF
C7	0.3 pF
L1	18 nH
L2	12 nH
R1	0.0 Ohm

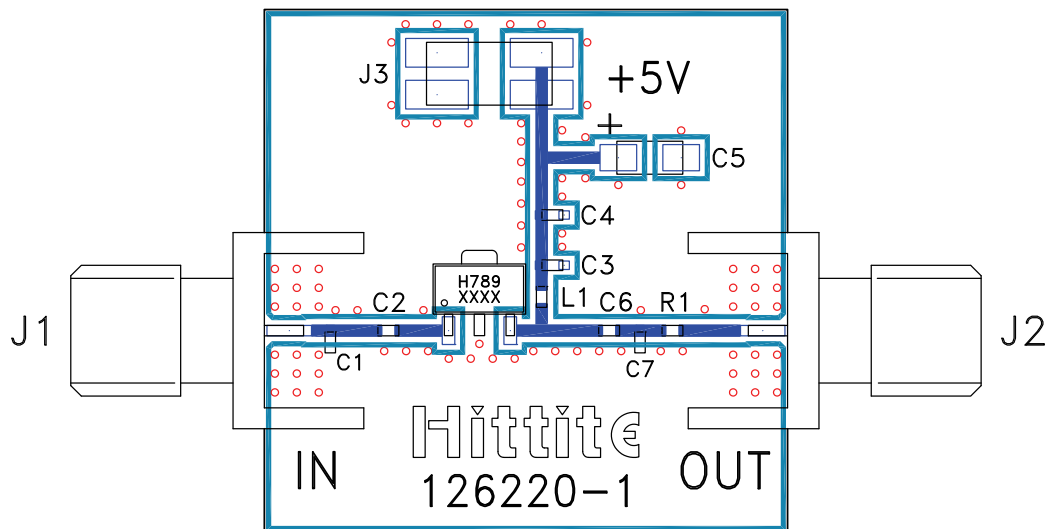
**InGaP HBT GAIN BLOCK MMIC
AMPLIFIER, 0.7 -2.8 GHz**
2600 MHz Evaluation PCB

List of Materials for 2600 MHz Evaluation PCB 125682 [1]

Item	Description
J1 - J2	PCB Mount SMA Connector
J3	2 mm DC Header
C1	1.5 pF Capacitor, 0402 Pkg.
C2	1.5 pF Capacitor, 0402 Pkg.
C3	100 pF Capacitor, 0402 Pkg.
C4	1000 pF Capacitor, 0402 Pkg.
C5	2.2 μ F Capacitor, Tantalum
C6	20 pF Capacitor, 0402 Pkg.
C7	0.3 pF Capacitor, 0402 Pkg.
L1	18 nH Inductor, 0402 Pkg.
R1	0.0 Ohm Resistor, 0402 Pkg.
U1	HMC789ST89E Linear Amplifier
PCB [2]	125220 Evaluation PCB

[1] Reference this number when ordering complete evaluation PCB

[2] Circuit Board Material: FR4

The circuit board used in this application should use RF circuit design techniques. Signal lines should have 50 Ohm impedance while the package ground leads and exposed paddle should be connected directly to the ground plane similar to that shown. A sufficient number of via holes should be used to connect the top and bottom ground planes. The evaluation board should be mounted to an appropriate heat sink. The evaluation circuit board shown is available from Hittite upon request.