

## MODELS APLR - APOLLO 6-DIGIT RATE INDICATOR [TIME BASE]

- 6-DIGIT, 0.56" (14.2 mm) HIGH LED DISPLAY
- CRYSTAL-CONTROLLED TIME-BASE PROGRAMMABLE UP TO 32.764 SECONDS PROVIDES DIRECT-READING FOR ANY RATE UNITS
- 0.02% ACCURACY
- PROGRAMMABLE DECIMAL POINTS
- FREQUENCY DOUBLING
- PROGRAMMABLE INPUT CIRCUIT, ACCEPTS OUTPUTS FROM A WIDE VARIETY OF SENSORS
- LEADING ZERO BLANKING
- POWER-UP SELF-TEST
- NEMA 4/IP65 SEALED FRONT METAL BEZEL



### DESCRIPTION

The Apollo Time Base Rate Indicators (Model APLR) has the ability to scale for direct readout in terms of the units being measured. Whether a machine produces bottles, cloth, wire, or beverage mix, operation is enhanced when the rate readout is expressed directly in bottles/min., feet/min., gallons/hour, or whatever units are needed in plant operations. The APLR can provide this capability through its settable time base, programmable decimal points, and frequency doubling functions.

The APLR can also accommodate magnetic pickups, as well as logic (*sourcing output*) sensors and NPN open collector (*sinking output*) sensors.

This unit also has a self-test feature, which checks all the micro-processor and display driver circuitry after power-up (*if enabled*). This self-test also can be used to test the time base select DIP switches and decimal point select DIP switches, to make certain all switches are functioning properly.

Power and input connections are made via a removable terminal block, located at the rear of the unit. Each terminal can accept one #14 AWG wire. DIP switches at the side of the unit are used to program the input configuration.

The Apollo Rate Indicator has a sealed metal die-cast bezel which meets NEMA 4/IP65 specifications for wash-down and/or dust, when properly installed. Two mounting clips are provided for easy installation. The Time Base Rate Indicator uses a 6-digit, 0.56" (14.2 mm) high LED display, which is readable to 23 feet (7 M).

### ORDERING INFORMATION

MODEL NO.	DESCRIPTION	PART NUMBER
APLR	Apollo Time Base Rate Indicator 115 VAC	APLR0600

### SAFETY SUMMARY

All safety related regulations, local codes and instructions that appear in the manual or on equipment must be observed to ensure personal safety and to prevent damage to either the instrument or equipment connected to it. If equipment is used in a manner not specified by the manufacturer, the protection provided by the equipment may be impaired.

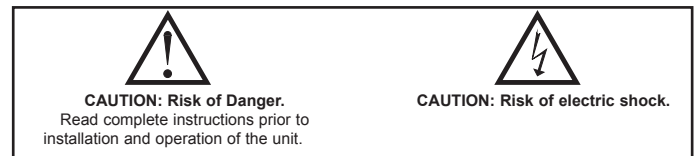

### SPECIFICATIONS

- DISPLAY:** 6-Digit, 0.56" (14.2 mm) high LED display.
- POWER REQUIREMENTS:**  
**AC Operation:** 115 VAC, ±10%, 50/60 Hz, 14 VA  
**DC Operation:** 11 to 14 VDC @ 0.6 A max. Terminal #3 (+VDC) & #4 (common)
- SENSOR POWER:** +12 VDC, ±25% @ 100 mA max.
- MAXIMUM OPERATING FREQUENCY:** 10 KHz, 50% duty cycle. 10,000 cps with min. pulse width "ON" and "OFF" times of 50 µsec.
- TIME BASE SELECTION RANGE:** 0.004 to 32.764 seconds.
- ACCURACY:** 0.02%
- MAXIMUM INPUT VOLTAGE AND CURRENT:** When the "SIG. IN" (Terminal 5) is driven from external signal voltages, max. voltage swing is ±50 V peak. Input voltage can be dropped by an external series resistance that limits input current to ±5 mA. (*These ratings are for S3 "OFF".*)

### DIMENSIONS In inches (mm)

Note: Recommended minimum clearance (behind the panel) for mounting clip installation is 2.1" (53.4) H x 5.5" (140) W.

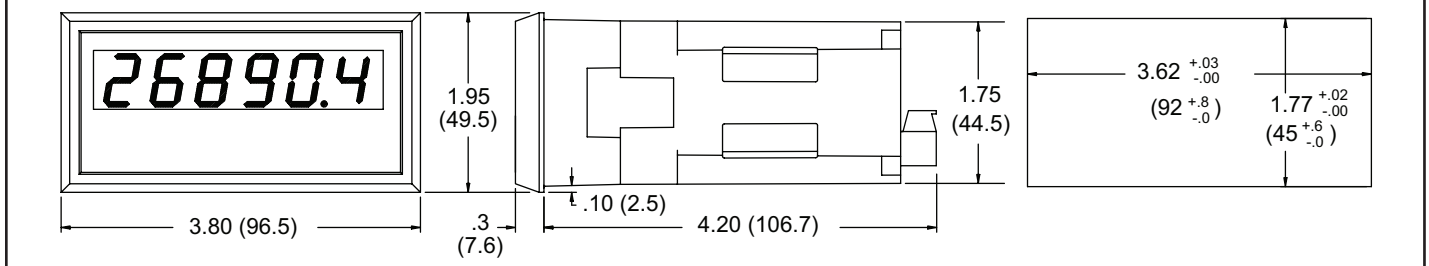

## SPECIFICATIONS (Con't)

8. **INPUT IMPEDANCE:** With S1 and S3 "OFF", the resistive input impedance exceeds 1megohm as long as the "SIG. IN" (Terminal 5) input voltage is between zero and +12 VDC. Beyond these levels, the high and low clamping diode will start to conduct, thus decreasing the input impedance. With S3 "ON" the maximum input voltage to Terminal 5 must be limited to 28 VDC.
9. **INPUT AND POWER CONNECTIONS:** There is a plug-in, compression-type, terminal block located at the rear of the unit. This block can be removed from the rear of the unit for ease of wiring. After wiring is complete, the connector can be plugged back onto the unit.
10. **CERTIFICATIONS AND COMPLIANCES:**

### SAFETY

IEC 61010-1, EN 61010-1: Safety requirements for electrical equipment for measurement, control, and laboratory use. Part 1.

IP65 Enclosure rating (Face only), IEC 529

Type 4 Enclosure rating (Face only), UL50

### ELECTROMAGNETIC COMPATIBILITY

#### Immunity to EN 50082-2

Electrostatic discharge	EN 61000-4-2	Level 2; 4 Kv contact <sup>1</sup> Level 3; 8 Kv air
Electromagnetic RF fields	EN 61000-4-3	Level 3; 10 V/m 80 MHz - 1 GHz
Fast transients (burst)	EN 61000-4-4	Level 4; 2 Kv I/O <sup>2</sup> Level 3; 2 Kv power
RF conducted interference	EN 61000-4-6	Level 3; 10 V/rms 150 KHz - 80 MHz
Power frequency magnetic fields	EN 61000-4-8	Level 4; 10 A/m
Simulation of cordless telephone	ENV 50204	Level 3; 10 V/m 900 MHz $\pm$ 5 MHz 200 Hz, 50% duty cycle

#### Emissions to EN 50081-2

RF interference	EN 55011	Enclosure class A Power mains class A
-----------------	----------	--

#### Notes:

1. Metal bezel of unit connected to earth ground (protective earth) at the mounting panel.
2. EMI filter placed on the DC power supply, when DC powered: Corcom #IVB3 or Schaffner #FN2010-1/07 (RLC #LFIL0000).

Refer to the EMC Installation Guidelines section of this bulletin for additional information.

### 11. ENVIRONMENTAL CONDITIONS:

**Operating Temperature Range:** 0 to 50°C

**Storage Temperature Range:** -40 to 70°C

**Vibration to IEC 68-2-6:** Operational 5-150 Hz, 2 g.

**Shock to IEC 68-2-27:** Operational 30 g.

**Operating and Storage Humidity:** 85% max. relative humidity (non-condensing) from 0°C to 50°C.

**Altitude:** Up to 2000 meters

12. **CONSTRUCTION:** Die-cast metal front bezel with black, high impact plastic insert. Front panel meets NEMA 4/IP65 requirements for indoor use when properly installed. Installation Category II, Pollution Degree 2. (Panel gasket and mounting clips included with unit.)

13. **WEIGHT:** 1.5 lbs (0.8 Kgs)

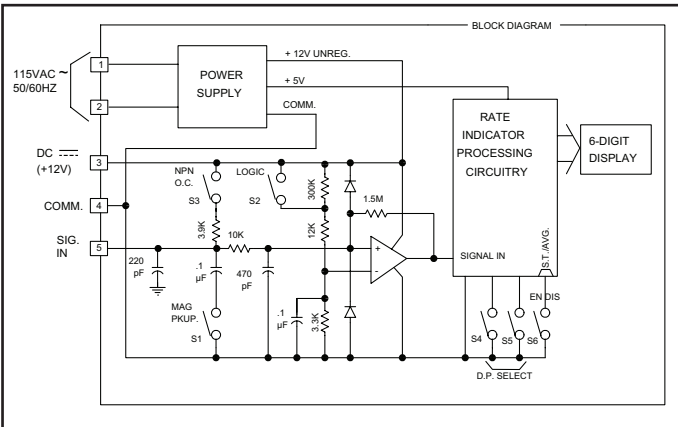

## INPUT SET-UP

The selection of input set-up is accomplished by the first three of six DIP switches, located along the side of the unit. DIP switches 1-3 are used to configure the input. Each of these switches are discussed below.

*Note: Rate indicators frequently use magnetic pickups for input devices, while contact input is never used due to speed and contact bounce limitations. Consequently, there are basic differences between counter and rate-indicator input circuits. In the Model APLR input circuit, the hysteresis level is quite small and the bias levels are significantly different to accommodate both magnetic pickup inputs, as well as the +5 V and higher logic levels.*

**S1 - ON [MAG.PKUP.]:** Connects a 0.1  $\mu$ F damping input capacitor from input to common. This capacitor is used only with magnetic pickup inputs and serves to filter out high frequency noise. S1 should be set in the "OFF" position when using inputs other than magnetic pickups.

**S2 - ON [LOGIC]:** Sets the bias reference so that input logic signals trigger count pulses as they cross a level of approximately +2.5 V.

**OFF:** Sets the bias reference so that a signal of 150 mV or more will trigger count pulses. This provides the sensitivity required for low speed magnetic pickup sensors.

*Note: Hysteresis for both S2 "ON" and "OFF" conditions is about 25 mV. This means the difference between  $V_{IL}$  and  $V_{IH}$  with logic inputs (S2) is almost insignificant and only a very small swing about the 2.5 V bias level will trigger the input.*

**S3 - ON [NPN O.C.]:** Connects a 3.9 K pull-up load resistor for sensors or circuits with current sink output. Sensor output must sink 4 mA @  $V_{OL}$  of 1 V or less.

## DECIMAL POINT SELECTION

The selection of Decimal Point is accomplished by DIP switches 4 and 5. The table at the right shows what combination of switches is needed to obtain the desired decimal point location. The unit always has leading zero blanking. Note: D.P. will change only at the normal display update time of the unit.

SW 4	SW 5	D.P. LOCATION
$\downarrow$ (0)	$\downarrow$ (0)	0
$\uparrow$ (1)	$\downarrow$ (0)	0.0
$\downarrow$ (0)	$\uparrow$ (1)	0.00
$\uparrow$ (1)	$\uparrow$ (1)	0.000

## REAR PANEL DIP SWITCHES

As can be seen from the rear of the unit, there is a row of 14 DIP switches located beside the input and power terminal block. DIP switches 1 through 13 are Time Base Increments. When the switch is "ON", it will add time to the Time Base Increment total.

DIP switch 14 is the Frequency Doubling DIP switch. When it is "ON", twice the number of input pulses are registered in the unit. Doubling the input rate allows the Time Base Increment total to be halved, thus allowing faster update times with the same value displayed.

## SELF-TEST

This unit has a built-in self-test feature which can only be activated immediately after power-up (the unit will not count while in self-test). To activate self-test, set the self-test DIP switch (D.S. 6) to the enable position. Then power the unit up. With this test, all digits are cycled through starting with a string of six zeros. This will be shown for about half a second, then a string of ones will appear for about the same time duration. Following these, a string of twos and so on, up to nines will be displayed. After the nines are shown, a string of decimal points will appear. Next an interlace pattern of 1, 0, 1, 0, 1, 0, then 1, 2, 1, 2, 1, 2, and so on, until all digits from zero to nine have been displayed.

The next portion of self-test will display four groups of zeros and/or ones. (The first two digits from the left, in each group, will always show a zero.) In the first group, the third digit represents the 13th (X4096) DIP switch setting. The fourth and fifth digits show the setting for the Decimal Point select DIP switches. (The fourth position digit represents DIP switch 4 and the fifth position digit represents DIP switch 5.) The state of these digits coincide with the table under the "Decimal Point Selection" section. The last digit will always show a one.

The next three groups are shown on the right, and correspond to the DIP switch shown directly above it. (Note: The first two digits in each group are always shown as zeros.)

			9	10	11	12 (DIP SWITCH)
Group 2:	0	0	X	X	X	X
			5	6	7	8 (DIP SWITCH)
Group 3:	0	0	X	X	X	X
			1	2	3	4 (DIP SWITCH)
Group 4:	0	0	X	X	X	X

The X's represent a zero or one (depending on the setting of the DIP switch) in the display. Self-test is automatically exited 8 seconds after the last DIP switch change is made.

## EMC INSTALLATION GUIDELINES

Although Red Lion Controls Products are designed with a high degree of immunity to Electromagnetic Interference (EMI), proper installation and wiring methods must be followed to ensure compatibility in each application. The type of the electrical noise, source or coupling method into a unit may be different for various installations. Cable length, routing, and shield termination are very important and can mean the difference between a successful or troublesome installation. Listed are some EMI guidelines for a successful installation in an industrial environment.

1. A unit should be mounted in a metal enclosure, which is properly connected to protective earth.
2. Use shielded cables for all Signal and Control inputs. The shield connection should be made as short as possible. The connection point for the shield depends somewhat upon the application. Listed below are the recommended methods of connecting the shield, in order of their effectiveness.
  - a. Connect the shield to earth ground (protective earth) at one end where the unit is mounted.
  - b. Connect the shield to earth ground at both ends of the cable, usually when the noise source frequency is over 1 MHz.
3. Never run Signal or Control cables in the same conduit or raceway with AC power lines, conductors, feeding motors, solenoids, SCR controls, and heaters, etc. The cables should be run through metal conduit that is properly grounded. This is especially useful in applications where cable runs are long and portable two-way radios are used in close proximity or if the installation is near a commercial radio transmitter. Also, Signal or Control cables within an enclosure should be routed as far away as possible from contactors, control relays, transformers, and other noisy components.
4. Long cable runs are more susceptible to EMI pickup than short cable runs.
5. In extremely high EMI environments, the use of external EMI suppression devices such as Ferrite Suppression Cores for signal and control cables is effective. The following EMI suppression devices (or equivalent) are recommended:

Fair-Rite part number 0443167251 (RLC part number FCOR0000)

Line Filters for input power cables:

Schaffner # FN2010-1/07 (Red Lion Controls # LFIL0000)

- a. Using a snubber, which is a resistor-capacitor (RC) network or metal oxide varistor (MOV) across an AC inductive load is very effective at reducing EMI and increasing relay contact life.
  - b. If a DC inductive load (such as a DC relay coil) is controlled by a transistor switch, care must be taken not to exceed the breakdown voltage of the transistor when the load is switched. One of the most effective ways is to place a diode across the inductive load. Most RLC products with solid state outputs have internal zener diode protection. However external diode protection at the load is always a good design practice to limit EMI. Although the use of a snubber or varistor could be used.
- RLC part numbers: Snubber: SNUB0000  
Varistor: ILS11500 or ILS23000
7. Care should be taken when connecting input and output devices to the instrument. When a separate input and output common is provided, they should not be mixed. Therefore a sensor common should NOT be connected to an output common. This would cause EMI on the sensitive input common, which could affect the instrument's operation.

Visit RLC's web site at <http://www.redlion.net/Support/InstallationConsiderations.html> for more information on EMI guidelines, Safety and CE issues as they relate to Red Lion Controls products.

## WIRING CONNECTIONS

As depicted in the drawing showing the rear view of the Apollo Rate Indicator, there is a terminal block where all wiring connections are made. All conductors should meet voltage and current ratings for each terminal. Also cabling should conform to appropriate standards of good installation, local codes and regulations. It is recommended that power supplied to the unit be protected by a fuse or circuit breaker. Remove the block for easy access to the terminal screws. To remove the block, pull from the back of the block until it slides clear of the terminal block shroud.



**CAUTION:** The terminal block should NOT be removed with power applied to the unit.

## POWER WIRING

Primary AC power is connected to Terminals 1 and 2 (marked 115VAC 50/60 Hz, located on the left-hand side of the block). For best results, the AC power should be relatively "clean" and within the specified  $\pm 10\%$  variation limit. Drawing power from heavily loaded circuits or from circuits that also power loads that cycle on and off, should be avoided.

Terminal 3 is the "DC" (+12 V) terminal. This terminal is for sensor supply and can provide up to 100 mA of current. An external +11 V to +14 VDC can also be applied to this terminal to power the unit in the absence of A.C. power. Terminal 4 is the "COMM." (common) terminal, which is the common line to which the sensor and other input commons are connected. Terminal 5 is the "SIG. IN" (signal in) terminal. When a frequency is present at this terminal, the rate will be displayed on the unit. (See "Maximum Input Voltage and Current" under "Specifications" section.)

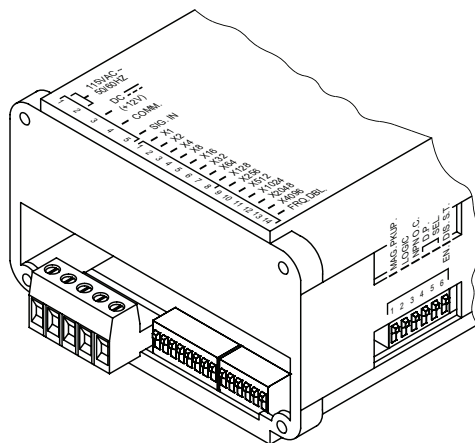

# CONNECTIONS & CONFIGURATION SWITCH SET-UP FOR VARIOUS SENSOR OUTPUTS

## COUNT SWITCH OR ISOLATED TRANSISTOR OUTPUTS

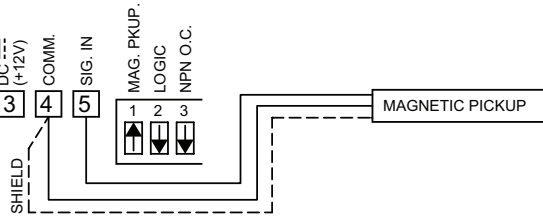

### RECOMMENDED RULES FOR MAGNETIC PICKUP CONNECTIONS

1. Use 2-wire shielded cable for magnetic pickup signal leads.
2. Never run signal cable in conduit, troughs, or cable bundles with power carrying conductors.
3. Connect the shield to the common Terminal "4" at the input of the instrument. Do NOT connect the shield at the pickup end, leave it "open" and insulate the exposed shield to prevent electrical contact with the frame or case. (Shielded cable, supplied on most RLC magnetic pickups, has open shield on pickup end.)

## SENSORS WITH CURRENT SINK OUTPUT (NPN O.C.)

[Includes ASTC, LMPC, PSAC]

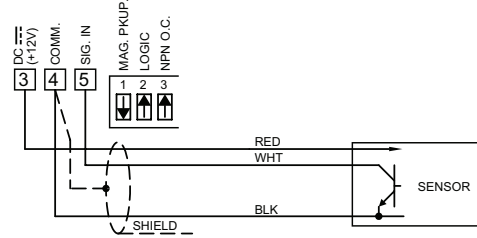

## SENSORS WITH CURRENT SOURCE OUTPUT (PNP O.C.)

\* EXTERNAL PULL-DOWN RESISTOR REQUIRED. VALUE MAY DEPEND ON SENSORS, BUT 10K OHM SHOULD BE ADEQUATE FOR MOST CASES.

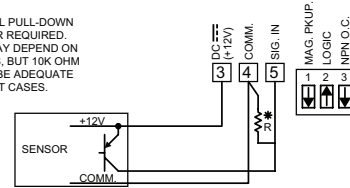

## TWO WIRE PROXIMITY SENSORS

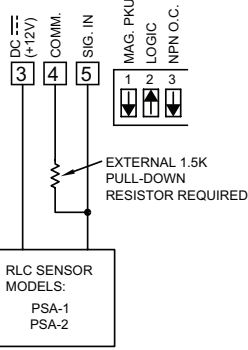

## OLDER STYLE, SENSORS WITH -EF OUTPUT

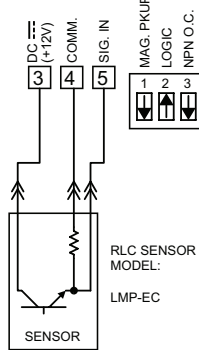

## A.C. INPUTS FROM TACH. GENERATORS, INVERTERS, ETC.

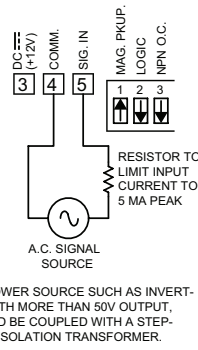

## INPUT FROM CMOS & OTHER BI-POLAR OUTPUTS

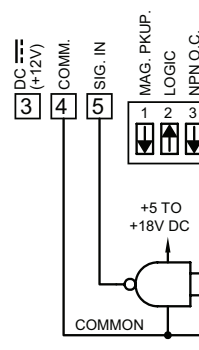

## INPUT FROM TTL

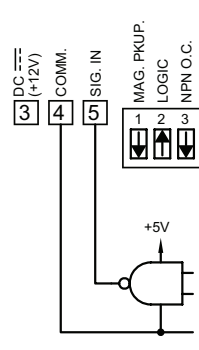

## INSTALLATION ENVIRONMENT

The unit should be installed in a location that does not exceed the maximum operating temperature and provides good air circulation. Placing the unit near devices that generate excessive heat should be avoided.

The bezel should be cleaned only with a soft cloth and neutral soap product. Do NOT use solvents.

Continuous exposure to direct sunlight may accelerate the aging process of the bezel.

Do not use tools of any kind (screwdrivers, pens, pencils, etc.) to operate the keypad of the unit.

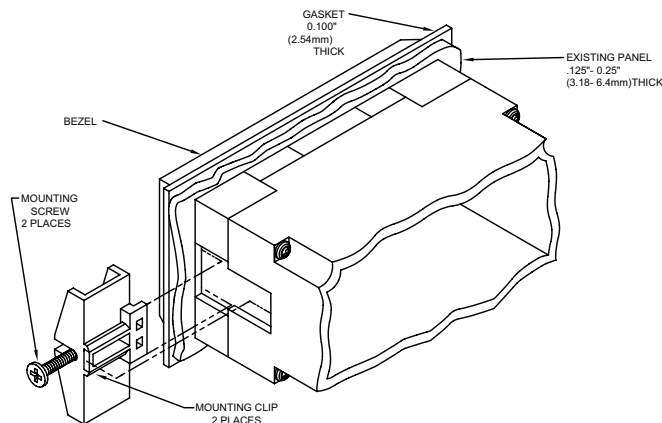

## INSTALLATION

The unit meets NEMA 4/IP65 requirements for indoor use, when properly installed. The units are intended to be mounted into an enclosed panel with a gasket to provide a water-tight seal. Two mounting clips and screws are provided for easy installation. Consideration should be given to the thickness of the panel. A panel which is too thin may distort and not provide a water-tight seal. (Recommended minimum panel thickness is 1/8".)

Cut the panel opening to the specified dimensions. Remove burrs and clean around the panel opening. Slide the panel gasket over the rear of the bezel. Insert the unit into the panel. As depicted in the drawing, install the screws into the narrow end of the mounting clips. Thread the screws into the clips until the pointed end just protrudes through the other side. Install each of the mounting clips by inserting the wide lip of the clips into the wide end of the hole, located on either side of the case. Then snap the clip onto the case.

Tighten the screws evenly to apply uniform compression, thus providing a water-tight seal. CAUTION: Only minimum pressure is required to seal panel. Do NOT overtighten screws.

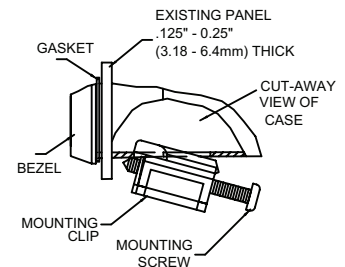

## TIME BASE SETTING PROCEDURE

The Apollo Time Base Rate Indicator has a time base selection range of 0.004 sec. to 32.764 sec. For a minimum time base (0.004 sec.), the X1 DIP switch is set to "ON". For the maximum time base, all the DIP switches would be set to "ON" (these add up to 8191). Therefore, a specific time base is achieved by adding up the appropriate individual time base increments.

The time base increment total is computed according to the following formula:

$$\text{TIME BASE INCREMENT} = \frac{(\text{Display Readout Desired}) \times \text{DDP} \times (15,000)}{\text{TOTAL (TBIT)} \quad [(\text{Known RPM}) \times (\text{Known PPR})] *}$$

\* - Input Pulse Rate Per Minute.

**DDP:** Use one of the following numbers in the above formula for the Display Decimal Point (DDP) position.

0	=	1
0.0	=	10
0.00	=	100

DISPLAY READOUT DESIRED = 1800 (Direct Readout in RPM)  
 REVOLUTIONS PER MINUTE = 1800  
 PULSES PER REVOLUTION = 60

$$\text{TBIT} = \frac{1,800 \times 1 \times 15,000}{1,800 \times 60} = 250 \left[ \begin{array}{l} \text{round to the nearest} \\ \text{whole number} \end{array} \right]$$

The appropriate Time Base switches, which together add up to 250, are then set "ON". Start by selecting the first increment which is greater than half the desired TBIT, and add subsequent increments that are more than half the difference needed.

		TBIT = 250	
DIP switch 8	. . . . .	- 128	Needed = 122
DIP switch 7	. . . . .	- 64	Needed = 58
DIP switch 6	. . . . .	- 32	Needed = 26
DIP switch 5	. . . . .	- 16	Needed = 10
DIP switch 4	. . . . .	- 8	Needed = 2
DIP switch 2	. . . . .	- 2	

As shown above, DIP switches 2 and 4-8 are all set to "ON". If it is desired to know what the time is in seconds, multiply 250 x 0.004 sec. = 1 sec.

*Note: This is the set-up for a one-second time base, which allows for direct readout of RPM.*

## FLOW RATE INDICATION APPLICATION

A positive displacement pump is driven by a gear reducer and an AC motor. The magnetic pickup (which senses the gear) in combination with the pump and reducer, provides 560 pulses for every gallon of fluid passing through the pump. The Model APLR is used to read directly in tenths of gallons/min. in flow rates up to 45 gallons/min. The following logical steps can be used to determine the time base value required for direct readout. At 45 GPM, the number of output pulses would be as follows:

$$45 \text{ gallons/min.} \times 560 \text{ pulses/gallon} = 25,200 \text{ pulses/min.}$$

Using the TBIT formula:

$$\text{TBIT} = \frac{(45) \times (10)^* \times 15,000}{25,200^{**}}$$

$$= 267.857 \left[ \begin{array}{l} \text{round to the nearest} \\ \text{whole number} \end{array} \right]$$

\* - For Tenths Position      \*\* - Input Pulse Rate Per Minute

$$\text{TBIT} = 268$$

DIP switch 9	. . . . .	- 256	Needed = 12
DIP switch 4	. . . . .	- 8	Needed = 4
DIP switch 3	. . . . .	- 4	

From the above calculation, DIP switches 3, 4, and 9, would be set to the "ON" position. The tenths position decimal point must also be set to "ON". So the display will show 45.0 when 45 gallons are passing through the pump every minute.

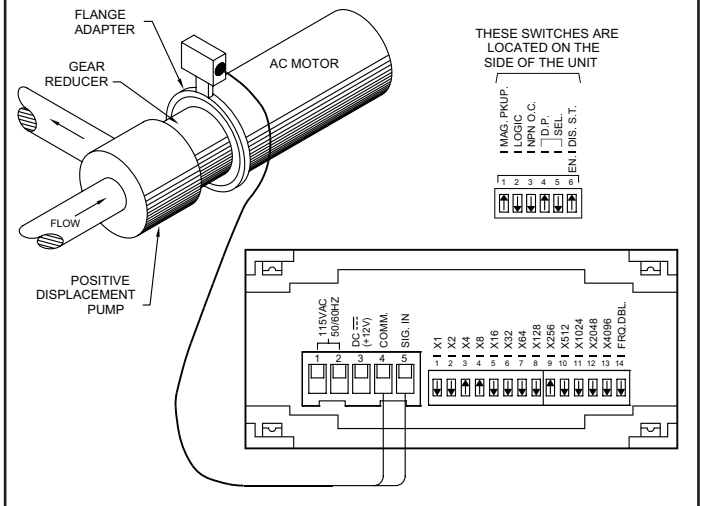

## WEB SPEED INDICATION APPLICATION

A newspaper publishing company wants to know the rate at which their printing press is operating. A fifty-tooth timing sprocket is mounted to the shaft of one of the press rollers. An MP-62TA magnetic pickup is used to sense the moving teeth. Direct readout is obtained by setting the time base to a period in which the number of teeth passing the pickup is numerically equal to the desired readout. Using the TBIT formula, the following calculations are performed:

$$\begin{aligned} \text{TIME BASE INCREMENT} &= \frac{(\text{Display Readout Desired}) \times (15,000)}{\text{TOTAL (TBIT)}} \\ &= \frac{(632) \times (15,000)}{(1419) \times (50)} \\ &= 133.6 \left[ \begin{array}{l} \text{round to the nearest} \\ \text{whole number} \end{array} \right] \end{aligned}$$

\* - Input Pulse Rate Per Minute.

	TBIT = 134		
DIP switch 8 . . . . .	- 128	Needed =	6
DIP switch 3 . . . . .	- 4	Needed =	2
DIP switch 2 . . . . .	- 2		

DIP switches 2, 3, and 8, are set to "ON". If the rounding error introduced above is unacceptable, the display could be scaled up by a factor of 10 and then a decimal point turned on in the tenths position. The calculations would be as follows:

$$\begin{aligned} \text{TBIT} &= (\text{Display Readout Desired} \times 10) \times 15,000 \\ &= \frac{(6320) \times (15,000)}{(1419) \times (50)} \\ \text{TBIT} &= 1336 \end{aligned}$$

DIP switch 11 . . . . .	- 1024	Needed =	312
DIP switch 9 . . . . .	- 256	Needed =	56
DIP switch 6 . . . . .	- 32	Needed =	24
DIP switch 5 . . . . .	- 16	Needed =	8
DIP switch 4 . . . . .	- 8		

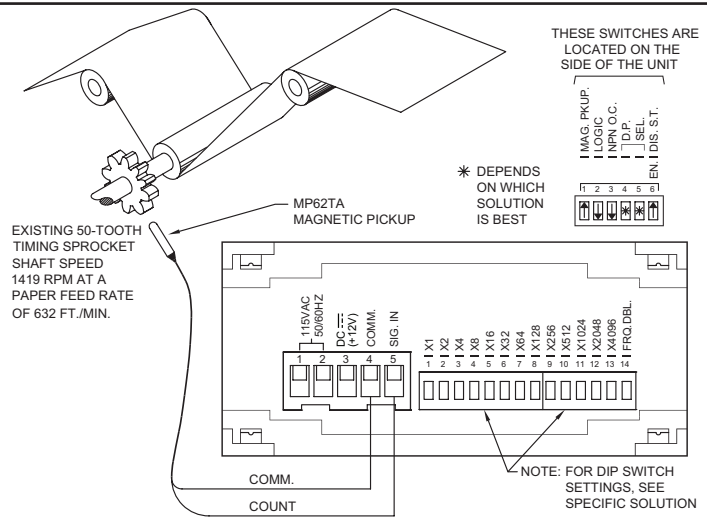

Now DIP switches, 4, 5, 6, 9, and 11, are set to "ON". Also, the tenths position decimal point would be set to "ON". (Note: If the time base is now too long, approximately 5.3 sec. the "FRQ. DBL." DIP switch can be set to "ON", then only half the time base will be necessary.

$$\text{TBIT} = \frac{(6320) \times (15,000)}{(1419) \times (2) \times (50)}$$

	TBIT = 668		
DIP switch 10 . . . . .	- 512	Needed =	156
DIP switch 8 . . . . .	- 128	Needed =	28
DIP switch 5 . . . . .	- 16	Needed =	12
DIP switch 4 . . . . .	- 8	Needed =	4
DIP switch 3 . . . . .	- 4		

DIP switches 3, 4, 5, 8, and 10, are all set to "ON" along with the tenths position decimal point. The time base, in seconds, is  $668 \times 0.004 = 2.67$  sec.

## TROUBLESHOOTING

For further technical assistance, contact technical support at the appropriate company numbers listed.

This page intentionally left blank

### **LIMITED WARRANTY**

The Company warrants the products it manufactures against defects in materials and workmanship for a period limited to two years from the date of shipment, provided the products have been stored, handled, installed, and used under proper conditions. The Company's liability under this limited warranty shall extend only to the repair or replacement of a defective product, at The Company's option. The Company disclaims all liability for any affirmation, promise or representation with respect to the products.

The customer agrees to hold Red Lion Controls harmless from, defend, and indemnify RLC against damages, claims, and expenses arising out of subsequent sales of RLC products or products containing components manufactured by RLC and based upon personal injuries, deaths, property damage, lost profits, and other matters which Buyer, its employees, or sub-contractors are or may be to any extent liable, including without limitation penalties imposed by the Consumer Product Safety Act (P.L. 92-573) and liability imposed upon any person pursuant to the Magnuson-Moss Warranty Act (P.L. 93-637), as now in effect or as amended hereafter.

No warranties expressed or implied are created with respect to The Company's products except those expressly contained herein. The Customer acknowledges the disclaimers and limitations contained herein and relies on no other warranties or affirmations.

Red Lion Controls  
Headquarters  
20 Willow Springs Circle  
York PA 17406  
Tel +1 (717) 767-6511  
Fax +1 (717) 764-0839

Red Lion Controls  
Europe  
Softwareweg 9  
NL - 3821 BN Amersfoort  
Tel +31 (0) 334 723 225  
Fax +31 (0) 334 893 793

Red Lion Controls  
India  
201-B, 2nd Floor, Park Centra  
Opp 32 Mile Stone, Sector-30  
Gurgaon-122002 Haryana, India  
Tel +91 984 487 0503

Red Lion Controls  
China  
Unit 302, XinAn Plaza  
Building 13, No.99 Tianzhou Road  
ShangHai, P.R. China 200223  
Tel +86 21 6113 3688  
Fax +86 21 6113 3683