

# Versatile Filtered Power Entry Module



- Rated currents up to 10 A
- For one or two fuses
- Fuses Ø6.3 x 32 mm or Ø5 x 20 mm
- 2-pole rocker switch
- Voltage selector
- Optional earth line choke (E type)



### Performance indicators

Attenuation performance



Rated current [A]



## Technical specifications

<b>Maximum continuous operating voltage</b>	250 VAC, 50/60 Hz
<b>Operating frequency</b>	DC to 400 Hz
<b>Rated currents</b>	1 to 10 A @ 40°C max.
<b>High potential test voltage</b>	P → PE 2000 VAC for 2 sec P → N 760 VAC for 2 sec
<b>Protection category</b>	IP 40 according to IEC 60529
<b>Temperature range (operation and storage)</b>	-25°C to +85°C (25/85/21)
<b>Design corresponding to</b>	UL 1283, CSA 22.2 No. 8 1986, IEC/EN 60939
<b>Flammability corresponding to</b>	UL 94V-2 or better
<b>MTBF @ 40°C/230 V (Mil-HB-217F)</b>	2,200,000 hours
<b>Voltage selector description</b>	
<b>Function</b>	Series/parallel
<b>Voltage marking</b>	
<b>Series</b>	110-120 V
<b>Parallel</b>	220-240 V
<b>Rocker switch description</b>	
<b>Function</b>	2-pole, dark not illuminated Marking I - 0
<b>Electrical specifications</b>	Inrush current 51 A 6,000 on-off operations according to UL 1054, TV 5 10,000 on-off operations according to ENEC
<b>Mechanical life</b>	50,000 cycles
<b>Switch ratings</b>	
<b>USA (UL) and Canada (C-UL)</b>	10 A, 125 VAC; 10 A, 250 VAC; 1/3 HP
<b>Europe (ENEC)</b>	10 A (4 A), 250 VAC*

\* Value in () relates to the inductive current charge:  $\cos \varphi=0.65$

### Approvals



The FN 390 power entry module combines an IEC inlet, mains filter with single or dual-fuse holder, voltage selector and 2-pole rocker switch. Choosing FN 390 product line brings you the rapid availability of a standard filter associated with the necessary safety acceptances. Standard IEC connector filters are a practical solution helping you to pass EMI system approval in a short time. Multiple options designed to offer you the desired solution.

### Features and benefits

- High conducted attenuation performance, based on chokes with high saturation resistance and excellent thermal behavior
- Rear or front mounting
- Single or dual-fuse holder
- USA Ø6.3 x 32 mm or EU Ø5 x 20 mm fuses
- 2-pole rocker switch
- Voltage selector 110-120 V/220-240 V
- Custom-specific versions are available on request

### Typical applications

- Portable electrical and electronic equipment
- Consumer goods
- EDP and office equipment
- Single-phase power supplies, switch-mode power supplies
- Test and measurement equipment

### Typical electrical schematic

#### Standard types

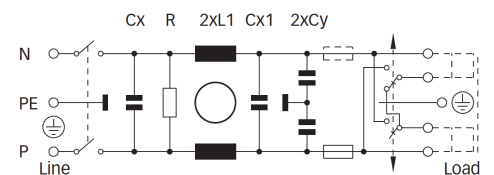

#### E types

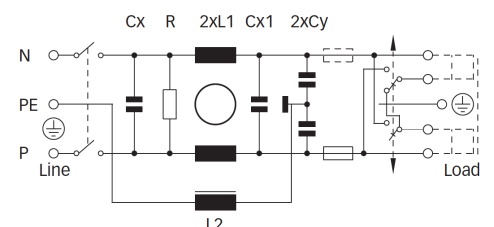

## Filter selection table

Filter	Rated current @ 40°C (25°C) [A]	Leakage current* @ 230 VAC/50 Hz [µA]	Inductance		Capacitance			Resistance R [kΩ]	Output connections 	Fuses** [Qty]	Weight [g]
			L1 [mH]	L2 [mH]	Cx [nF]	Cx1 [nF]	Cy [nF]				
<b>FN 393-1-05-11</b>	1 (1.2)	560	7.5		220		3.3	1000	05-11	1	200
<b>FN 393-2.5-05-11</b>	2.5 (3)	560	2		220		3.3	1000	05-11	1	200
<b>FN 393-6-05-11</b>	6 (7.2)	560	0.45		220		3.3	1000	05-11	1	200
<b>FN 394-1-05-11</b>	1 (1.2)	560	7.5		220		3.3	1000	05-11	2	200
<b>FN 394-2.5-05-11</b>	2.5 (3)	560	2		220		3.3	1000	05-11	2	200
<b>FN 394-6-05-11</b>	6 (7.2)	560	0.45		220		3.3	1000	05-11	2	200
<b>FN 393 E-1-05-11</b>	1 (1.2)	560	7.5	0.4	220		3.3	1000	05-11	1	205
<b>FN 393 E-2.5-05-11</b>	2.5 (3)	560	2	0.4	220		3.3	1000	05-11	1	205
<b>FN 393 E-6-05-11</b>	6 (7.2)	560	0.45	0.4	220		3.3	1000	05-11	1	205
<b>FN 394 E-1-05-11</b>	1 (1.2)	560	7.5	0.4	220		3.3	1000	05-11	2	205
<b>FN 394 E-2.5-05-11</b>	2.5 (3)	560	2	0.4	220		3.3	1000	05-11	2	205
<b>FN 394 E-6-05-11</b>	6 (7.2)	560	0.45	0.4	220		3.3	1000	05-11	2	205
<b>FN 1393-1-05-11</b>	1 (1.2)	797	16		220	100	4.7	470	05-11	1	210
<b>FN 1393-2.5-05-11</b>	2.5 (3)	797	8		220	100	4.7	470	05-11	1	210
<b>FN 1393-6-05-11</b>	6 (7.2)	797	2.5		220	100	4.7	470	05-11	1	210
<b>FN 1393-10-05-11</b>	10 (12)	797	0.6		220	100	4.7	470	05-11	1	210
<b>FN 1394-1-05-11</b>	1 (1.2)	797	16		220	100	4.7	470	05-11	2	210
<b>FN 1394-2.5-05-11</b>	2.5 (3)	797	8		220	100	4.7	470	05-11	2	210
<b>FN 1394-6-05-11</b>	6 (7.2)	797	2.5		220	100	4.7	470	05-11	2	210
<b>FN 1394-10-05-11</b>	10 (12)	797	0.6		220	100	4.7	470	05-11	2	210

\* Maximum leakage under normal operating conditions. Note: if the neutral line is interrupted, worst case leakage could reach twice this level.

\*\* Filters are delivered without fuse.

Note: for medical versions please contact your local partner within Schaffner's global network.

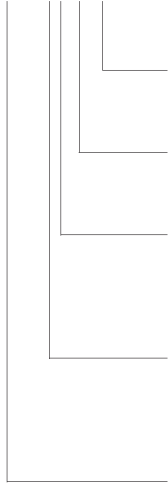
Product selector	
FN (1)39xx-y-zz	
	
05-11:	Faston 6.3 x 0.8mm
1 to 10:	Rated current
Blank:	Standard version
E:	Optional earth line choke
3:	1 fuse (Ø5 x 20mm or Ø6.3 x 32mm)
4:	2 fuses (Ø5 x 20mm or Ø6.3 x 32mm)
Blank:	Standard version
1:	Additional Cx1 capacitor and higher inductivity

For example: FN 393-1-05-11, FN 394 E-2.5-05-11, FN 1394-10-05-11

### Typical filter attenuation

Per CISPR 17; A=50 Ω/50 Ω sym; B=50 Ω/50 Ω asym; C=0.1 Ω/100 Ω sym; D=100 Ω/0.1 Ω sym

FN 39x: 1 A types

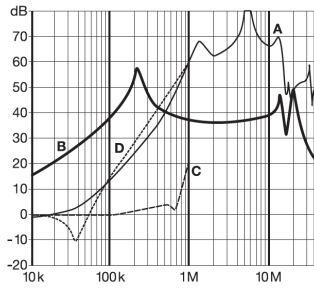

FN 39x: 2.5 A types

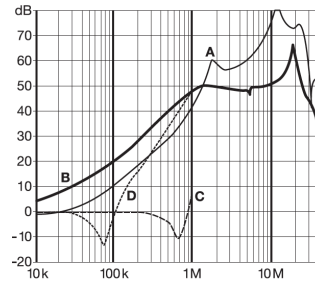

FN 39x: 6 A types

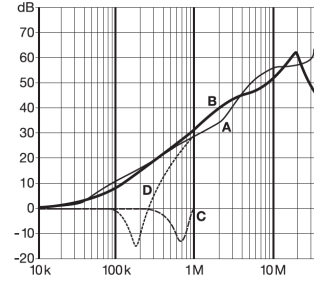

FN 139x: 1 A types

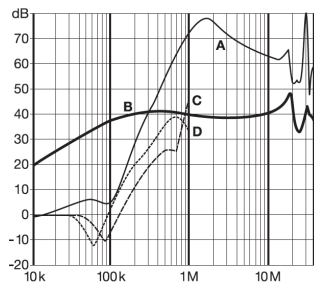

FN 139x: 2.5 A types

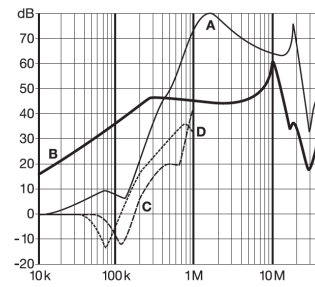

FN 139x: 6 and 10 A types

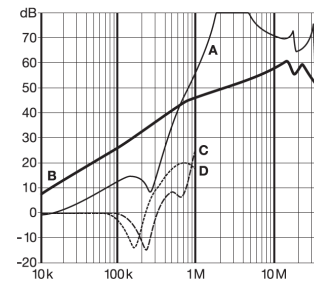

### Mechanical data

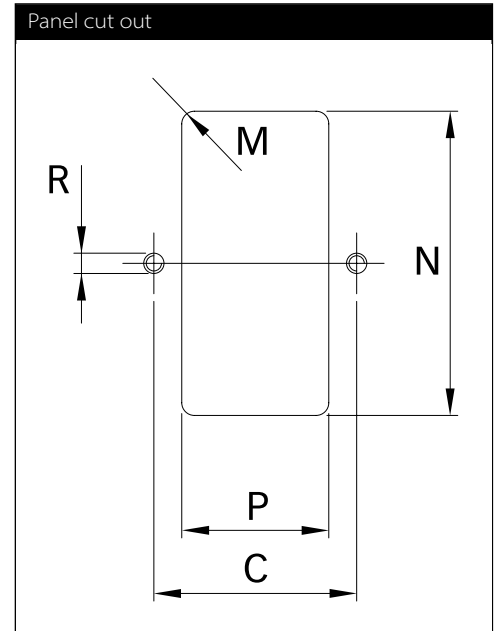
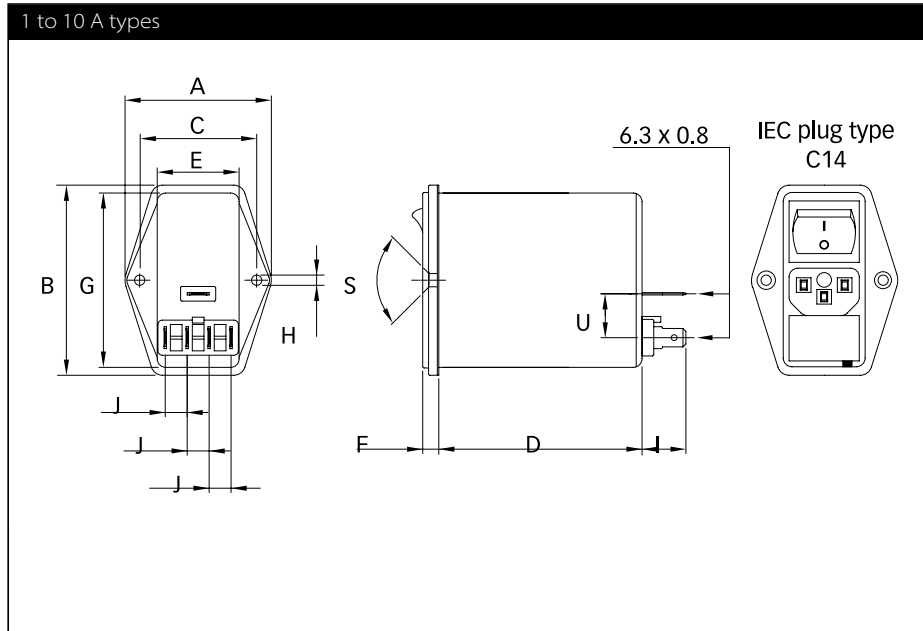

## Dimensions

	1 to 10 A	Tolerances
<b>A</b>	50	±0.3
<b>B</b>	65	±0.3
<b>C</b>	40	±0.1
<b>D</b>	69.5	±0.3
<b>E</b>	28	
<b>F</b>	5.5	±0.3
<b>G</b>	59.6	
<b>H</b>	Ø 3.3	
<b>I</b>	15	
<b>J</b>	7.5	
<b>M</b>	R ≤ 2.5	
<b>N</b>	60.00	±0.5
<b>P</b>	29.00	±0.5
<b>R</b>	M3	
<b>S</b>	90°	
<b>U</b>	15	

All dimensions in mm; 1 inch=25.4 mm  
Tolerances according: ISO 2768-m/EN 22768-m

Please visit [www.schaffner.com](http://www.schaffner.com) to find more details on filter connections.



## Headquarters, global innovation and development

### Switzerland

#### Schaffner Group

Nordstrasse 11  
4542 Luterbach  
T +41 32 681 66 26  
[info@schaffner.com](mailto:info@schaffner.com)  
<http://www.schaffner.com>



## Sales and application centers

### China

#### Schaffner EMC Ltd. Shanghai

T20-3 C, No 565 Chuangye Road,  
Pudong district  
201201 Shanghai  
T +86 21 3813 9500  
[cschina@schaffner.com](mailto:cschina@schaffner.com)  
<http://www.schaffner.com.cn>

### Finland

#### Schaffner Oy

Sauvonrinne 19 H  
08500 Lohja  
T +358 50 468 7284  
[finlandsales@schaffner.com](mailto:finlandsales@schaffner.com)

### France

#### Schaffner EMC S.A.S.

16-20 Rue Louis Rameau  
95875 Bezons  
T +33 1 34 34 30 60  
F +33 1 39 47 02 28  
[francesales@schaffner.com](mailto:francesales@schaffner.com)

### Germany

#### Schaffner Deutschland GmbH

Schoemperlenstrasse 12B  
76185 Karlsruhe  
T +49 721 56910  
F +49 721 569110  
[germanysales@schaffner.com](mailto:germanysales@schaffner.com)

### India

#### Schaffner India Pvt. Ltd

Unit 59, Level, Mfar Greenheart 7  
Manyata Tech Park, Hebbal Outer Ring Road  
560045 Bangalore  
T +91 80 6781 9805  
F +91 80 6781 9998  
[indiasales@schaffner.com](mailto:indiasales@schaffner.com)

### Italy

#### Schaffner EMC S.r.l.

Via Ticino, 30  
20900 Monza (MB)  
T +39 039 21 41 070  
[italysales@schaffner.com](mailto:italysales@schaffner.com)

### Japan

#### Schaffner EMC K.K.

1-32-12, Kamiyama, Setagaya-ku  
7F Mitsui-seimei Sangenjaya Bldg.  
154-0011 Tokyo  
T +81 3 5712 3650  
F +81 3 5712 3651  
[japansales@schaffner.com](mailto:japansales@schaffner.com)  
<http://www.schaffner.jp>

### Singapore

#### Schaffner EMC Pte Ltd.

#05-09, Kg Ubi Ind. Estate  
408705 Singapore  
T +65 6377 3283  
F +65 6377 3281  
[singaporesales@schaffner.com](mailto:singaporesales@schaffner.com)

### Spain

#### Schaffner EMC España

Calle Caléndula 93, Miniparc III, Edificio E  
El Soto de Moraleja, Alcobendas  
28109 Madrid  
T +34 917 912 900  
F +34 917 912 901  
[spainsales@schaffner.com](mailto:spainsales@schaffner.com)

### Sweden

#### Schaffner EMC AB

Tegeluddsvägen 76, 2tr  
115 28 Stockholm  
T +46 8 5050 2425  
[swedensales@schaffner.com](mailto:swedensales@schaffner.com)  
<http://www.schaffner.com>

### Switzerland

#### Schaffner EMV AG

Nordstrasse 11  
4542 Luterbach  
T +41 32 681 66 26  
[switzerlandsales@schaffner.com](mailto:switzerlandsales@schaffner.com)

### Taiwan R.O.C.

#### Schaffner EMV Ltd.

20 Floor-2, No 97, Section 1, XinTai 5th Road  
22175 XiZhi District New Taipei City 22175  
T +886 2 2697 5500  
F +886 2 2697 5533  
[taiwansales@schaffner.com](mailto:taiwansales@schaffner.com)  
<http://www.schaffner.com.tw>

### Thailand

#### Schaffner EMC Co. Ltd.

Northern Region Industrial Estate  
67 Moo 4 Tambon Ban Klang  
Amphur Muangng P.O. Box 14  
51000 Lamphun  
T +66 53 58 11 04  
F +66 53 58 10 19  
[thailandsales@schaffner.com](mailto:thailandsales@schaffner.com)

### United Kingdom

#### Schaffner Ltd.

5 Ashville Way, Molly Millars Lane  
Wokingham  
RG41 2PL Berkshire  
T +44 118 9770070  
F +44 118 9792969  
[uksales@schaffner.com](mailto:uksales@schaffner.com)

### USA

#### Schaffner EMC Inc.

52 Mayfield Avenue  
08837 Edison, New Jersey  
T +1 800 367 5566  
T +1 732 225 9533  
F +1 732 225 4789  
[usasales@schaffner.com](mailto:usasales@schaffner.com)  
<http://www.schaffnerusa.com>

#### Schaffner North America

6722 Thirlane Road  
24019 Roanoke, Virginia  
T +1 276 228 7943  
F +1 276 228 7953

#### Schaffner North America

823 Fairview Road  
24382 Wytheville, Virginia  
T +1 276 228 7943  
F +1 276 228 7258

To find your local partner within Schaffner's global network: [www.schaffner.com](http://www.schaffner.com)

© 2017 Schaffner Group

The content of this document has been carefully checked and understood. However, neither Schaffner nor its subsidiaries assume any liability whatsoever for any errors or inaccuracies of this document and the consequences thereof. Published specifications are subject to change without notice. Product suitability for any area of application must ultimately be determined by the customer. In all cases, products must never be operated outside their published specifications. Schaffner does not guarantee the availability of all published products. This disclaimer shall be governed by substantive Swiss law and resulting disputes shall be settled by the courts at the place of business of Schaffner Holding AG. Latest publications and a complete disclaimer can be downloaded from the Schaffner website. All trademarks recognized.