

REV.	DATE	DESCRIPTION
NC	05/17/99	INITIAL RELEASE
A	04/06/06	UPDATE DRAWING FORMAT
B	02/05/07	MODIFY NOTES

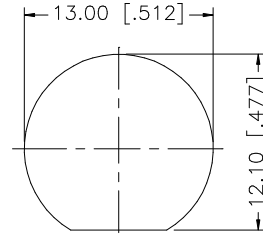

RECOMMENDED MOUNTING HOLE

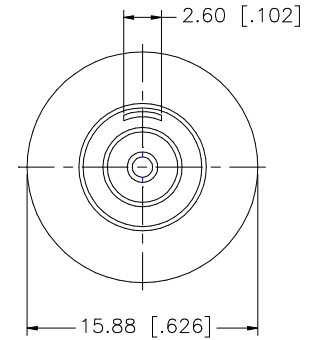
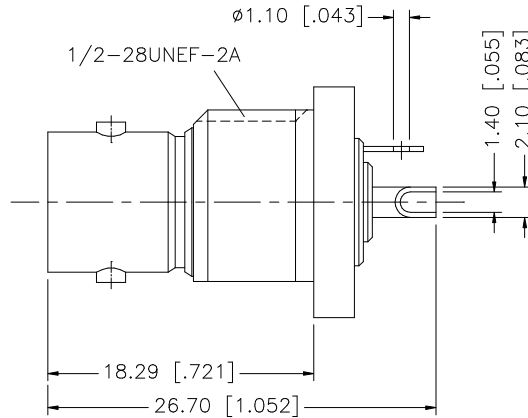
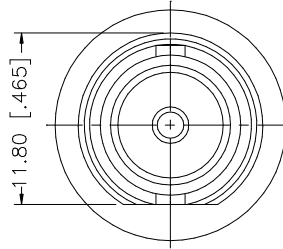
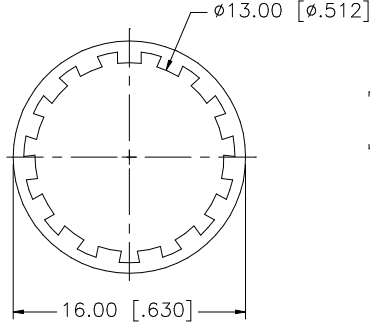
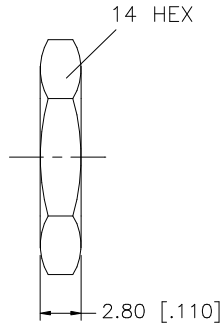

NOTE:

1. MAX. PANEL THICKNESS = 2.5mm
2. CONTACT PLATING: GOLD PL. 50MIN THICK OVER NICKEL PL. 100MIN THICK OVER COPPER STRIKE.

QTY	DESCRIPTION	MATERIAL	FINISH
1	HEX NUT	BRASS	NICKEL
1	LOCK WASHER	BRASS	NICKEL
1	CONTACT PIN	PHOS. BRONZE	SEE NOTE 2
1	INSULATOR	TEFLON	NATURAL
1	BODY	BRASS	NICKEL

UNLESS OTHERWISE SPECIFIED DIMENSIONS ARE IN MILLIMETERS. DIMENSIONS IN [] ARE IN INCHES AND FOR CUSTOMER REFERENCE ONLY.

UNLESS OTHERWISE SPECIFIED TOLERANCES FOR MILLIMETERS ARE:
0.5 - 8mm ± 0.20mm
8 - 30mm ± 0.40mm
30 - 120mm ± 0.50mm

UNLESS OTHERWISE SPECIFIED TOLERANCES FOR INCHES ARE:
.020 - .315 = ± 0.007"
.315 - 1.180 = ± 0.015"
1.180 - 4.724 = ± 0.020"

DO NOT SCALE DRAWING

APPROVALS	DATE
DRAWN G.R.S.	02/05/07
CHECKED	
ISSUED	
SHEET 1 OF 1	
CAD FILE C:/112/112624.DWG	

Amphenol Connex

PART DESCRIPTION
BNC BULKHEAD ISOLATED RECEPT. JACK 50ohm
PART NO.
112624
DWG. NO.
112624.DWG
REV.
B
SIZE
A
SCALE
NA