

# 12V AustinLynx™ 10A: Non-Isolated DC-DC Power Module, Programmable

10Vdc – 14Vdc input; 0.75Vdc to 5.5Vdc output; 10A Output

## RoHS Compliant



## Applications

- Distributed power architectures
- Intermediate bus voltage applications
- Telecommunications equipment
- Servers and storage applications
- Networking equipment

## Features

- Compliant to RoHS EU Directive 2011/65/EU (-Z versions)
- Compliant to RoHS EU Directive 2011/65/EU under exemption 7b (Lead solder exemption). Exemption 7b will expire after June 1, 2016 at which time this product will no longer be RoHS compliant (non-Z versions)
- Delivers up to 10A of output current
- High efficiency – 93% at 3.3V full load ( $V_{IN} = 12.0V$ )
- Small size and low profile:  
33.00 mm x 13.46 mm x 8.28 mm  
(1.300 in x 0.530 in x 0.326 in)
- Low output ripple and noise
- High Reliability:  
Calculated MTBF = 4.4 M hours at 25°C Full-load
- Output voltage programmable from 0.75 Vdc to 5.5 Vdc via external resistor
- Line Regulation: 0.3% (typical)
- Load Regulation: 0.4% (typical)
- Temperature Regulation: 0.4% (typical)
- Remote On/Off
- Remote Sense
- Output overcurrent protection (non-latching)
- Overtemperature protection
- Wide operating temperature range (-40°C to 85°C)
- UL\* 60950-1 Recognized, CSA† C22.2 No. 60950-1-03 Certified, and VDE‡ 0805:2001-12 (EN60950-1) Licensed
- ISO\*\* 9001 and ISO 14001 certified manufacturing facilities

## Description

The 12V Austin Lynx™ Programmable SMT (surface mount technology) power modules are non-isolated DC-DC converters that can deliver up to 10A of output current with full load efficiency of 93% at 3.3V output. These modules provide a precisely regulated output voltage programmable via an external resistor from 0.75Vdc to 5.5Vdc over a wide range of input voltage ( $V_{IN} = 10 - 14Vdc$ ). Their open-frame construction and small footprint enable designers to develop cost- and space-efficient solutions. Standard features include remote On/Off, remote sense, output voltage adjustment, overcurrent and overtemperature protection.

\* UL is a registered trademark of Underwriters Laboratories, Inc.

† CSA is a registered trademark of Canadian Standards Association.

‡ VDE is a trademark of Verband Deutscher Elektrotechniker e.V.

\*\* ISO is a registered trademark of the International Organization of Standards



# 12V AustinLynx™10A: Non-Isolated DC-DC Power Modules, Programmable

## 10Vdc – 14Vdc input; 0.75Vdc to 5.5Vdc output; 10A Output Current

### Absolute Maximum Ratings

Stresses in excess of the absolute maximum ratings can cause permanent damage to the device. These are absolute stress ratings only, functional operation of the device is not implied at these or any other conditions in excess of those given in the operations sections of the data sheet. Exposure to absolute maximum ratings for extended periods can adversely affect the device reliability.

| Parameter   | Device | Symbol    | Min  | Max | Unit |
|---|--------|-----------|------|-----|------|
| Input Voltage<br>Continuous   | All    | $V_{IN}$  | -0.3 | 15  | Vdc  |
| Operating Ambient Temperature<br>(see Thermal Considerations section) | All    | $T_A$     | -40  | 85  | °C   |
| Storage Temperature   | All    | $T_{stg}$ | -55  | 125 | °C   |

### Electrical Specifications

Unless otherwise indicated, specifications apply over all operating input voltage, resistive load, and temperature conditions.

| Parameter  | Device   | Symbol                                 | Min | Typ       | Max  | Unit             |
|--|--|--|-----|-----------|------|------------------|
| Operating Input Voltage  | All  | $V_{IN}$                               | 10  | 12.0      | 14.0 | Vdc              |
| Maximum Input Current<br>( $V_{IN} = V_{IN, min}$ to $V_{IN, max}$ , $I_O = I_{O, max}$ , $V_{O, set} = 3.3Vdc$ )  | All  | $I_{IN, max}$                          |     |           | 6.5  | Adc              |
| Input No Load Current<br>( $V_{IN} = 12.0Vdc$ , $I_O = 0$ , module enabled)  | $V_{O, set} = 0.75 Vdc$<br>$V_{O, set} = 3.3Vdc$ | $I_{IN, No load}$<br>$I_{IN, No load}$ |     | 40<br>100 |      | mA<br>mA         |
| Input Stand-by Current<br>( $V_{IN} = 12.0Vdc$ , module disabled)  | All  | $I_{IN, stand-by}$                     |     | 2.0       |      | mA               |
| Inrush Transient   | All  | $I^2t$                                 |     |           | 0.4  | A <sup>2</sup> s |
| Input Reflected Ripple Current, peak-to-peak<br>(5Hz to 20MHz, 1μH source impedance; $V_{IN, min}$ to $V_{IN, max}$ , $I_O = I_{O, max}$ ; See Test configuration section) | All  |  |     | 20        |      | mAp-p            |
| Input Ripple Rejection (120Hz)   | All  |  |     | 30        |      | dB               |

#### CAUTION: This power module is not internally fused. An input line fuse must always be used.

This power module can be used in a wide variety of applications, ranging from simple standalone operation to being part of a complex power architecture. To preserve maximum flexibility, internal fusing is not included, however, to achieve maximum safety and system protection, always use an input line fuse. The safety agencies require a fast-acting fuse with a maximum rating of 15 A (see Safety Considerations section). Based on the information provided in this data sheet on inrush energy and maximum dc input current, the same type of fuse with a lower rating can be used. Refer to the fuse manufacturer's data sheet for further information.

# 12V AustinLynx™10A: Non-Isolated DC-DC Power Modules, Programmable 10Vdc –14Vdc input; 0.75Vdc to 5.5Vdc output; 10A Output Current

## Electrical Specifications (continued)

| Parameter   | Device  | Symbol   | Min         | Typ  | Max          | Unit   |
|---|---|--|-------------|--|--------------|--|
| Output Voltage Set-point<br>( $V_{IN}=V_{IN, min}$ , $I_o=I_{o, max}$ , $T_A=25^\circ C$ )  | All   | $V_{O, set}$   | -2.0        | —  | +2.0         | % $V_{O, set}$                                     |
| Output Voltage<br>(Over all operating input voltage, resistive load, and temperature conditions until end of life)  | All   | $V_{O, set}$   | -2.5%       | —  | +3.5%        | % $V_{O, set}$                                     |
| Adjustment Range<br>Selected by an external resistor  | All   | $V_o$  | 0.7525      |  | 5.5          | % $V_{O, set}$                                     |
| Output Regulation<br>Line ( $V_{IN}=V_{IN, min}$ to $V_{IN, max}$ )<br>Load ( $I_o=I_{o, min}$ to $I_{o, max}$ )<br>Temperature ( $T_{ref}=T_{A, min}$ to $T_{A, max}$ )  | All<br>All<br>All   |  | —<br>—<br>— | 0.3<br>0.4<br>0.4                                    |              | % $V_{O, set}$<br>% $V_{O, set}$<br>% $V_{O, set}$ |
| Output Ripple and Noise on nominal output<br>( $V_{IN}=V_{IN, nom}$ and $I_o=I_{o, min}$ to $I_{o, max}$<br>$C_{out} = 1\mu F$ ceramic//10 $\mu F$ tantalum capacitors)   |   |  |             |  |              |  |
| RMS (5Hz to 20MHz bandwidth)  | All   |  | —           | 12   | 15           | mV <sub>rms</sub>                                  |
| Peak-to-Peak (5Hz to 20MHz bandwidth)   | All   |  | —           | 30   | 50           | mV <sub>pk-pk</sub>                                |
| External Capacitance<br>ESR $\geq 1$ m $\Omega$<br>ESR $\geq 10$ m $\Omega$   | All<br>All  | $C_{o, max}$<br>$C_{o, max}$                                       | —<br>—      | —<br>—   | 1000<br>5000 | $\mu F$<br>$\mu F$                                 |
| Output Current  | All   | $I_o$  | 0           | —  | 10           | A <sub>dc</sub>                                    |
| Output Current Limit Inception (Hiccup Mode )   | All   | $I_{o, lim}$   | —           | 200  | —            | % $I_o$  |
| Output Short-Circuit Current<br>( $V_o \leq 250$ mV) ( Hiccup Mode )  | All   | $I_{o, s/c}$   | —           | 3  | —            | A <sub>dc</sub>                                    |
| Efficiency<br>$V_{IN} = V_{IN, nom}$ , $T_A=25^\circ C$<br>$I_o=I_{o, max}$ , $V_o = V_{O, set}$  | $V_{O, set} = 0.75$ Vdc<br>$V_{O, set} = 1.2$ Vdc<br>$V_{O, set} = 1.5$ Vdc<br>$V_{O, set} = 1.8$ Vdc<br>$V_{O, set} = 2.5$ Vdc<br>$V_{O, set} = 3.3$ Vdc<br>$V_{O, set} = 5.0$ Vdc | $\eta$<br>$\eta$<br>$\eta$<br>$\eta$<br>$\eta$<br>$\eta$<br>$\eta$ |             | 81.0<br>87.5<br>89.0<br>90.0<br>92.0<br>93.0<br>95.0 |              | %<br>%<br>%<br>%<br>%<br>%<br>%                    |
| Switching Frequency   | All   | $f_{sw}$   | —           | 300  | —            | kHz  |
| Dynamic Load Response<br>( $dI_o/dt=2.5$ A/ $\mu s$ ; $V_{IN} = V_{IN, nom}$ ; $T_A=25^\circ C$ )<br>Load Change from $I_o= 50\%$ to $100\%$ of $I_{o, max}$ ;<br>1 $\mu F$ ceramic// 10 $\mu F$ tantalum<br>Peak Deviation<br>Settling Time ( $V_o < 10\%$ peak deviation) | All   | $V_{pk}$   | —           | 200  | —            | mV   |
| ( $dI_o/dt=2.5$ A/ $\mu s$ ; $V_{IN} = V_{IN, nom}$ ; $T_A=25^\circ C$ )<br>Load Change from $I_o= 100\%$ to $50\%$ of $I_{o, max}$ ;<br>1 $\mu F$ ceramic// 10 $\mu F$ tantalum<br>Peak Deviation<br>Settling Time ( $V_o < 10\%$ peak deviation)                          | All   | $t_s$<br>$V_{pk}$<br>$t_s$   | —<br>—<br>— | 25<br>200<br>25                                      | —<br>—<br>—  | $\mu s$<br>mV<br>$\mu s$                           |

# 12V AustinLynx™10A: Non-Isolated DC-DC Power Modules, Programmable 10Vdc –14Vdc input; 0.75Vdc to 5.5Vdc output; 10A Output Current

## Electrical Specifications (continued)

| Parameter  | Device | Symbol   | Min | Typ | Max | Unit    |
|--|--------|----------|-----|-----|-----|---------|
| Dynamic Load Response<br>( $dI_o/dt=2.5A/\mu s$ ; $V_{IN} = V_{IN, nom}$ ; $T_A=25^\circ C$ )<br>Load Change from $I_o= 50\%$ to $100\%$ of $I_{o,max}$ ;<br>$C_o = 2 \times 150 \mu F$ polymer capacitors<br>Peak Deviation | All    | $V_{pk}$ | —   | 100 | —   | mV      |
| Settling Time ( $V_o < 10\%$ peak deviation)   | All    | $t_s$    | —   | 25  | —   | $\mu s$ |
| ( $dI_o/dt=2.5A/\mu s$ ; $V_{IN} = V_{IN, nom}$ ; $T_A=25^\circ C$ )<br>Load Change from $I_o= 100\%$ to $50\%$ of $I_{o,max}$ ;<br>$C_o = 2 \times 150 \mu F$ polymer capacitors<br>Peak Deviation                          | All    | $V_{pk}$ | —   | 100 | —   | mV      |
| Settling Time ( $V_o < 10\%$ peak deviation)   | All    | $t_s$    | —   | 25  | —   | $\mu s$ |

## General Specifications

| Parameter  | Min | Typ       | Max | Unit    |
|--|-----|-----------|-----|---------|
| Calculated MTBF ( $I_o=I_{o,max}$ , $T_A=25^\circ C$ ) |     | 4,400,000 |     | Hours   |
| Weight   | —   | 5.6 (0.2) | —   | g (oz.) |

# 12V AustinLynx™10A: Non-Isolated DC-DC Power Modules, Programmable 10Vdc –14Vdc input; 0.75Vdc to 5.5Vdc output; 10A Output Current

## Feature Specifications

Unless otherwise indicated, specifications apply over all operating input voltage, resistive load, and temperature conditions. See Feature Descriptions for additional information.

| Parameter  | Device | Symbol   | Min         | Typ | Max      | Unit           |
|--|--------|----------|-------------|-----|----------|----------------|
| Remote On/Off Signal interface<br>( $V_{IN}=V_{IN, min}$ to $V_{IN, max}$ ; Open collector npn or equivalent<br>Compatible, Von/off signal referenced to GND<br>See feature description section)<br>Logic High (On/Off Voltage pin open - Module ON) |        |          |             |     |          |                |
| Von/Off  | All    | $V_{IH}$ | —           | —   | $V_{IN}$ | V              |
| Ion/Off  | All    | $I_{IH}$ | —           | —   | 10       | $\mu A$        |
| Logic Low (Von/Off $\leq 0.3V$ - Module Off)   |        |          |             |     |          |                |
| Von/Off  | All    | $V_{IL}$ | —           | —   | 0.3      | V              |
| Ion/off  | All    | $I_{IL}$ | —           | —   | 1        | mA             |
| Turn-On Delay and Rise Times<br>( $I_o=I_{o, max}$ , $V_{IN} = V_{IN, nom}$ , $T_A = 25^\circ C$ , )   |        |          |             |     |          |                |
| Case 1: On/Off input is set to Logic Low (Module ON) and then input power is applied (delay from instant at which $V_{IN} = V_{IN, min}$ until $V_o=10\%$ of $V_{o, set}$ )  |        | All      | $T_{delay}$ | 3   |          | msec           |
| Case 2: Input power is applied for at least one second and then the On/Off input is set to logic Low (delay from instant at which Von/Off=0.3V until $V_o=10\%$ of $V_{o, set}$ )  |        | All      | $T_{delay}$ | 3   |          | msec           |
| Output voltage Rise time (time for $V_o$ to rise from 10% of $V_{o, set}$ to 90% of $V_{o, set}$ )   |        | All      | $T_{rise}$  | 4   | 6        | msec           |
| Output voltage overshoot - Startup<br>$I_o= I_{o, max}$ ; $V_{IN} = 10.0$ to 14Vdc, $T_A = 25^\circ C$   |        |          |             | —   | 1        | % $V_{o, set}$ |
| Remote Sense Range   |        | All      |             | —   | 0.5      | V              |
| Overtemperature Protection<br>(See Thermal Consideration section)  |        | All      | $T_{ref}$   | —   | 125      | $^\circ C$     |
| Input Undervoltage Lockout   |        |          |             |     |          |                |
| Turn-on Threshold  |        | All      |             | —   | 8.2      | V              |
| Turn-off Threshold   |        | All      |             | —   | 8.0      | V              |

# 12V AustinLynx™10A: Non-Isolated DC-DC Power Modules, Programmable 10Vdc – 14Vdc input; 0.75Vdc to 5.5Vdc output; 10A Output Current

## Characteristic Curves

The following figures provide typical characteristics for the 12V Austin Lynx Programmable SMT modules at 25°C.

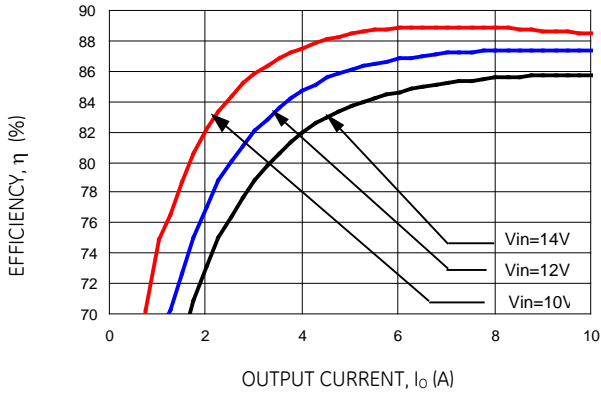

Figure 1. Converter Efficiency versus Output Current (Vout = 1.2Vdc).

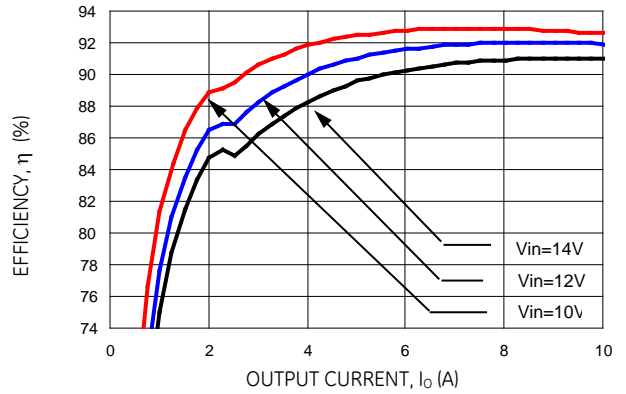

Figure 4. Converter Efficiency versus Output Current (Vout = 2.5Vdc).

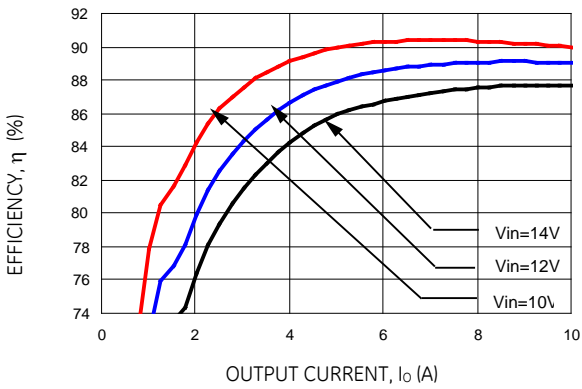

Figure 2. Converter Efficiency versus Output Current (Vout = 1.5Vdc).

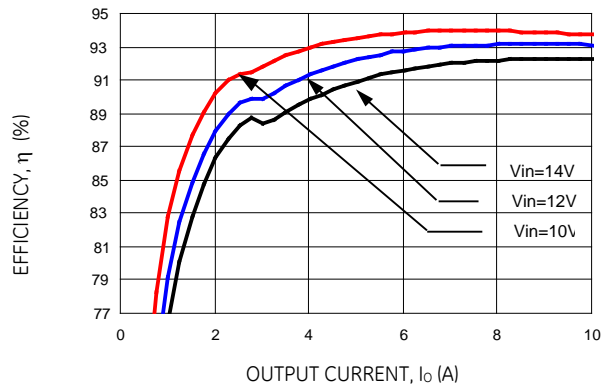

Figure 5. Converter Efficiency versus Output Current (Vout = 3.3Vdc).

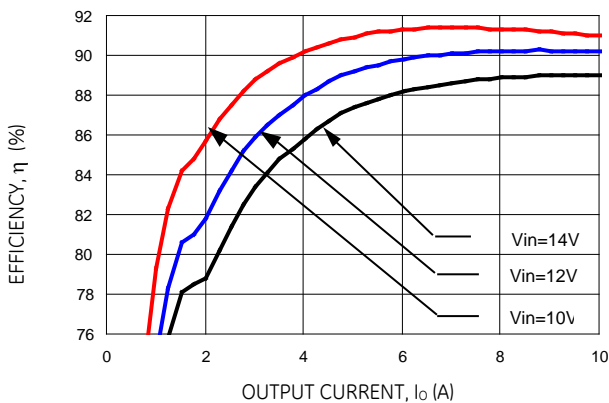

Figure 3. Converter Efficiency versus Output Current (Vout = 1.8Vdc).

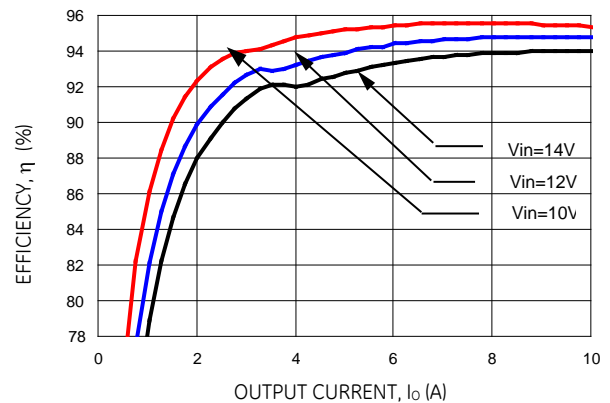
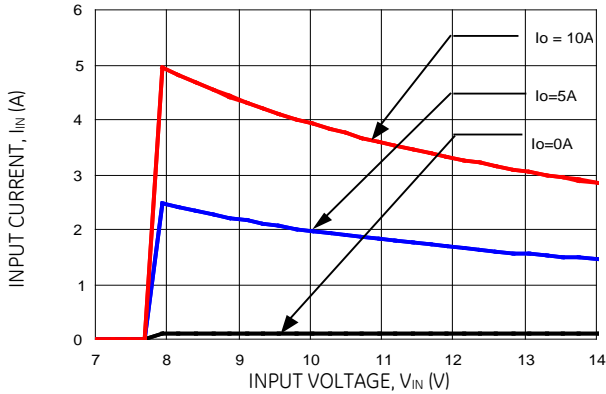

Figure 6. Converter Efficiency versus Output Current (Vout = 5.0Vdc).

# 12V AustinLynx™10A: Non-Isolated DC-DC Power Modules, Programmable 10Vdc – 14Vdc input; 0.75Vdc to 5.5Vdc output; 10A Output Current

## Characteristic Curves (continued)

The following figures provide typical characteristics for the 12V Austin Lynx Programmable SMT modules at 25°C.



**Figure 7. Input voltage vs. Input Current**  
(Vout = 3.3Vdc).

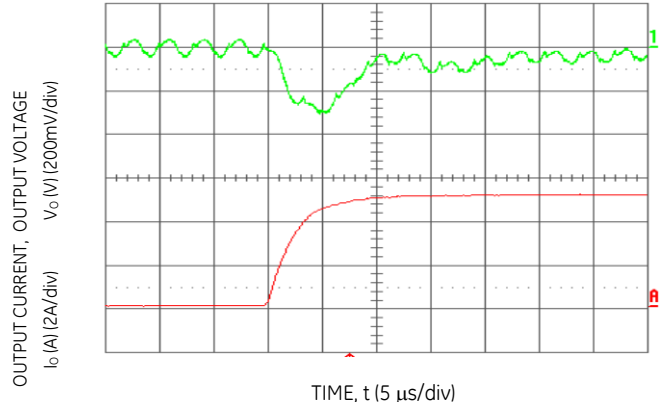

**Figure 10. Transient Response to Dynamic Load Change from 50% to 100% of full load (Vo = 3.3Vdc).**

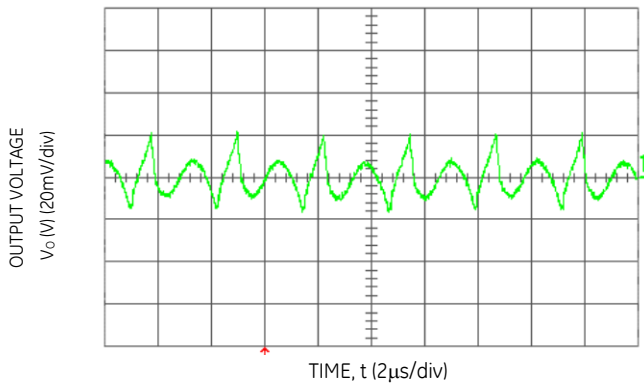

**Figure 8. Typical Output Ripple and Noise**  
(Vin = 12.0V dc, Vo = 2.5 Vdc, Io=10A).

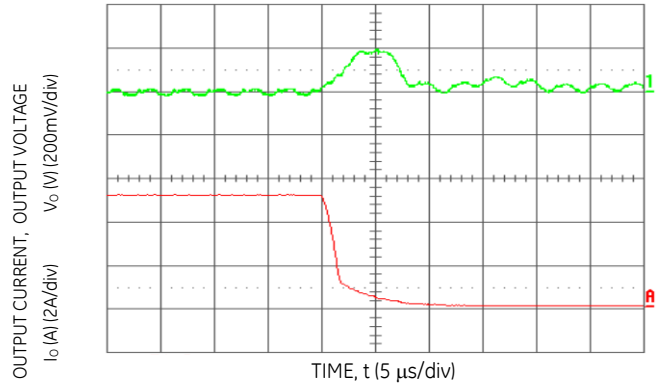

**Figure 11. Transient Response to Dynamic Load Change from 100% to 50% of full load (Vo = 3.3 Vdc).**

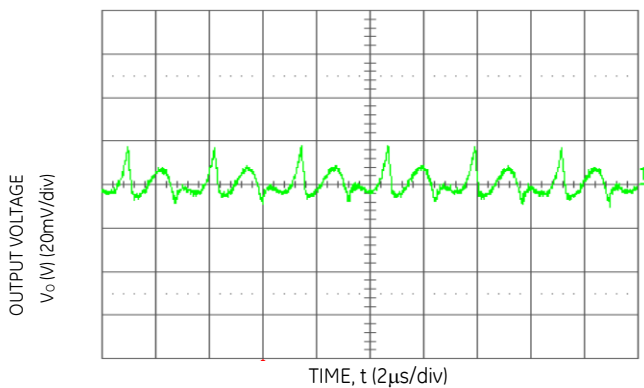

**Figure 9. Typical Output Ripple and Noise**  
(Vin = 12.0V dc, Vo = 5.0 Vdc, Io=10A).

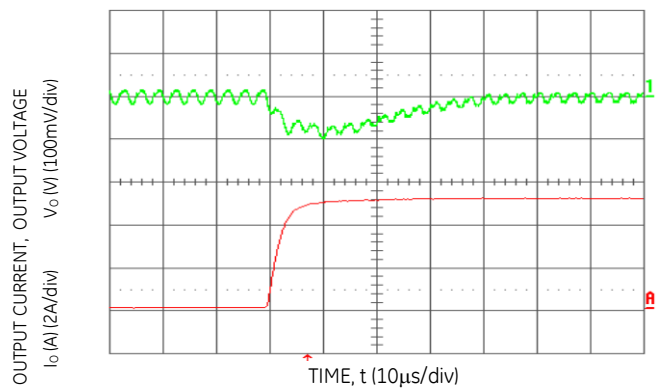
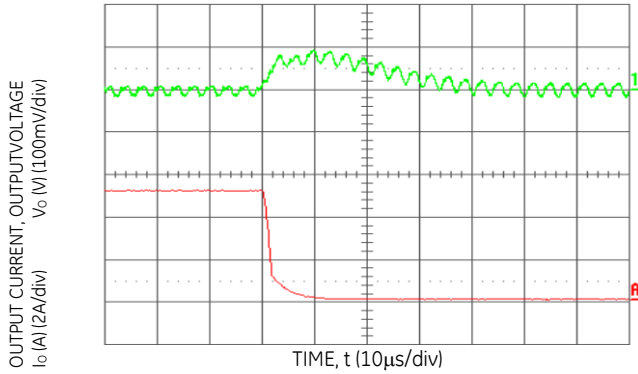

**Figure 12. Transient Response to Dynamic Load Change from 50% to 100% of full load (Vo = 3.3 Vdc, Cext = 2x150 µF Polymer Capacitors).**

# 12V AustinLynx™10A: Non-Isolated DC-DC Power Modules, Programmable 10Vdc –14Vdc input; 0.75Vdc to 5.5Vdc output; 10A Output Current

## Characteristic Curves (continued)

The following figures provide typical characteristics for the 12V Austin Lynx Programmable SMT modules at 25°C.



**Figure 13. Transient Response to Dynamic Load Change from 100% of 50% full load ( $V_o = 5.0\text{Vdc}$ ,  $C_{ext} = 2 \times 150\ \mu\text{F}$  Polymer Capacitors).**

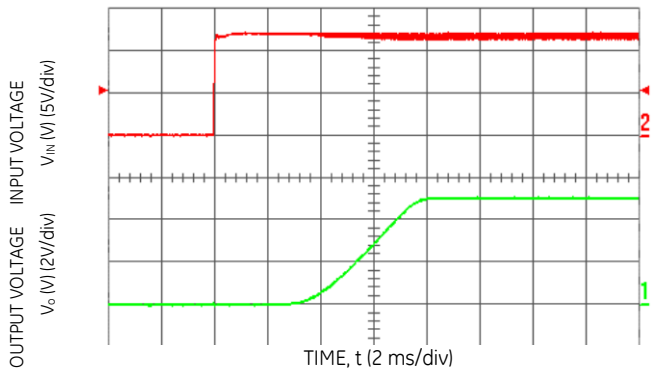

**Figure 16. Typical Start-Up with application of  $V_{in}$  with low-ESR polymer capacitors at the output ( $7 \times 150\ \mu\text{F}$ ) ( $V_{in} = 12\text{Vdc}$ ,  $V_o = 5.0\text{Vdc}$ ,  $I_o = 10\text{A}$ ,  $C_o = 1050\ \mu\text{F}$ ).**

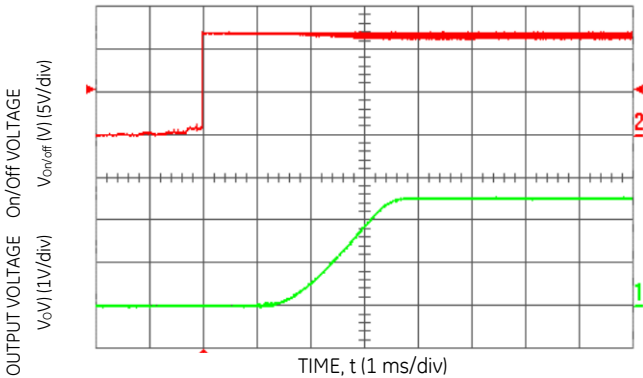

**Figure 14. Typical Start-Up Using Remote On/Off ( $V_{in} = 12.0\text{Vdc}$ ,  $V_o = 5.0\text{Vdc}$ ,  $I_o = 10.0\text{A}$ ).**

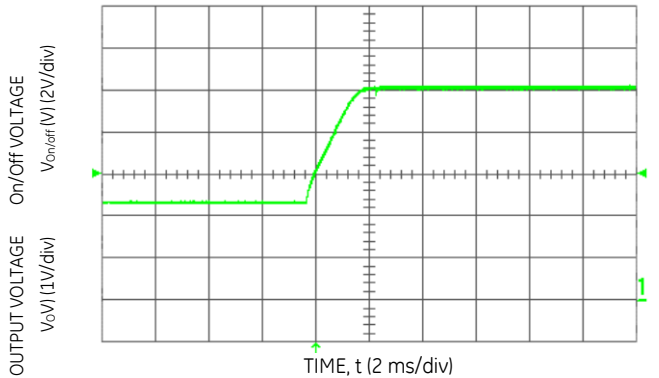

**Figure 17 Typical Start-Up Using Remote On/Off with Prebias ( $V_{in} = 12.0\text{Vdc}$ ,  $V_o = 2.5\text{Vdc}$ ,  $I_o = 1.0\text{A}$ ,  $V_{bias} = 1.2\text{Vdc}$ ).**

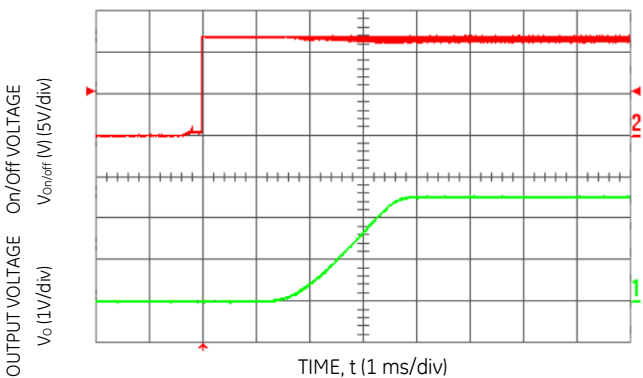

**Figure 15. Typical Start-Up Using Remote On/Off with Low-ESR external capacitors ( $C_o = 5000\ \mu\text{F}$ ) ( $V_{in} = 12.0\text{Vdc}$ ,  $V_o = 5.0\text{Vdc}$ ,  $I_o = 10.0\text{A}$ ,  $C_o = 1050\ \mu\text{F}$ ).**

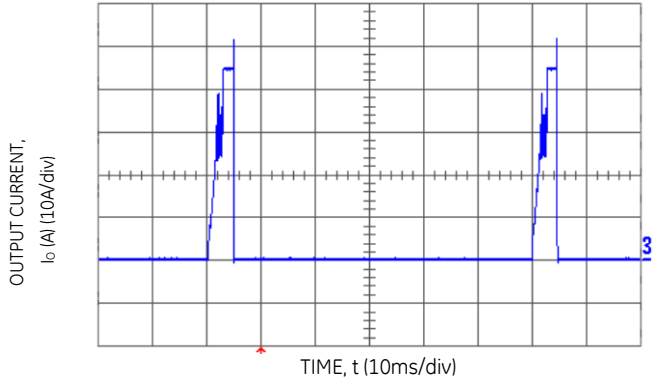

**Figure 18. Output short circuit Current ( $V_{in} = 12.0\text{Vdc}$ ,  $V_o = 0.75\text{Vdc}$ ).**



# 12V AustinLynx™10A: Non-Isolated DC-DC Power Modules, Programmable 10Vdc – 14Vdc input; 0.75Vdc to 5.5Vdc output; 10A Output Current

## Characteristic Curves (continued)

The following figures provide thermal derating curves for the 12V Austin Lynx Programmable SMT modules.

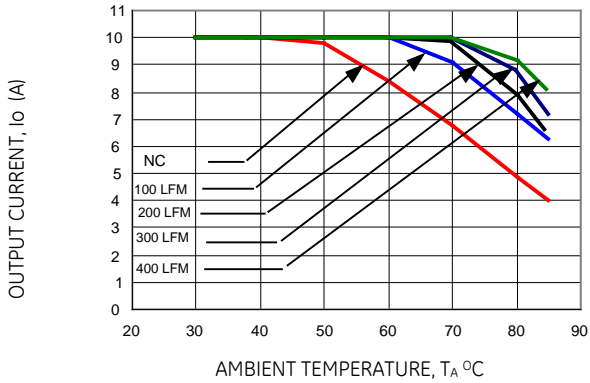

Figure 19. Derating Output Current versus Local Ambient Temperature and Airflow ( $V_{in} = 12.0$  Vdc,  $V_o=0.75$ Vdc).

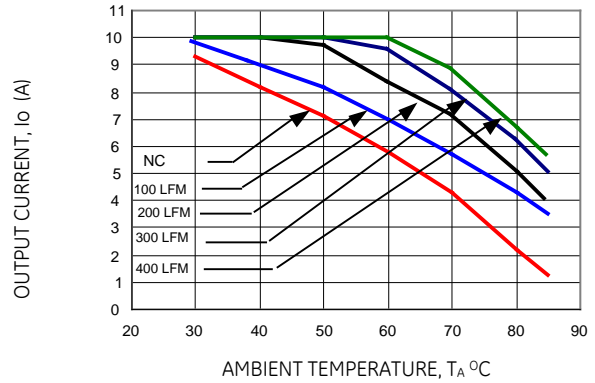

Figure 22. Derating Output Current versus Local Ambient Temperature and Airflow ( $V_{in} = 12.0$  Vdc,  $V_o=5.0$  Vdc).

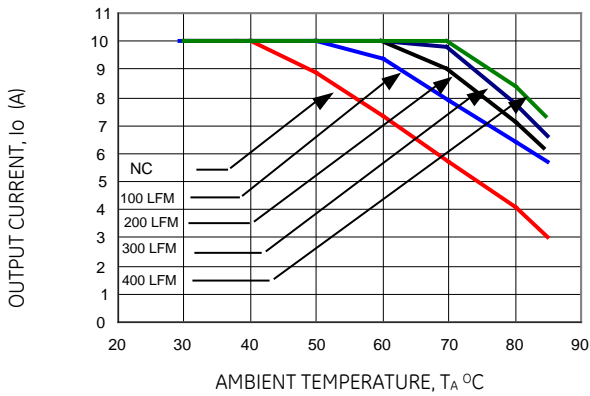

Figure 20. Derating Output Current versus Local Ambient Temperature and Airflow ( $V_{in} = 12.0$ Vdc,  $V_o=1.8$  Vdc).

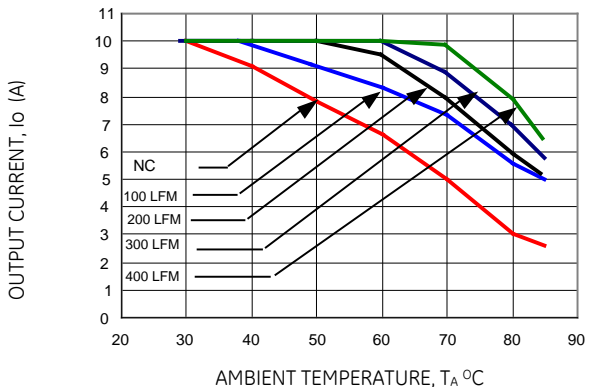
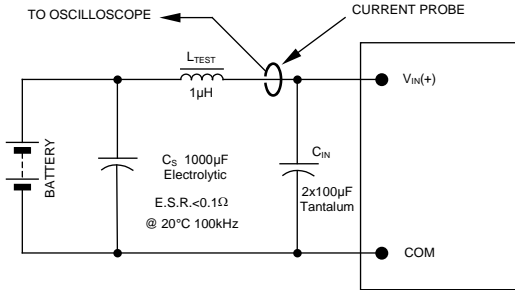

Figure 21. Derating Output Current versus Local Ambient Temperature and Airflow ( $V_{in} = 12.0$ Vdc,  $V_o=3.3$  Vdc).

# 12V AustinLynx™10A: Non-Isolated DC-DC Power Modules, Programmable 10Vdc –14Vdc input; 0.75Vdc to 5.5Vdc output; 10A Output Current

## Test Configurations



NOTE: Measure input reflected ripple current with a simulated source inductance ( $L_{TEST}$ ) of 1µH. Capacitor  $C_S$  offsets possible battery impedance. Measure current as shown above.

Figure 23. Input Reflected Ripple Current Test Setup.

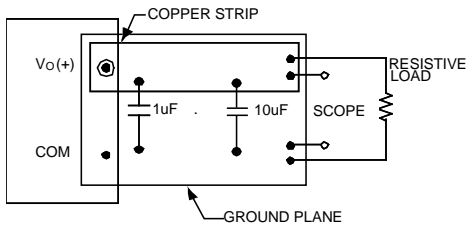

NOTE: All voltage measurements to be taken at the module terminals, as shown above. If sockets are used then Kelvin connections are required at the module terminals to avoid measurement errors due to socket contact resistance.

Figure 24. Output Ripple and Noise Test Setup.

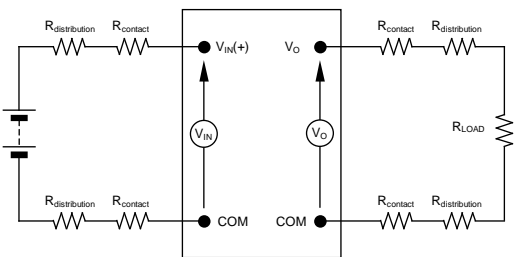

NOTE: All voltage measurements to be taken at the module terminals, as shown above. If sockets are used then Kelvin connections are required at the module terminals to avoid measurement errors due to socket contact resistance.

Figure 25. Output Voltage and Efficiency Test Setup.

$$\text{Efficiency } \eta = \frac{V_O \cdot I_O}{V_{IN} \cdot I_{IN}} \times 100 \%$$

## Design Considerations

### Input Filtering

The 12V Austin Lynx Programmable SMT module should be connected to a low ac-impedance source. A highly inductive source can affect the stability of the module. An input capacitance must be placed directly adjacent to the input pin of the module, to minimize input ripple voltage and ensure module stability.

In a typical application, 4x47 µF low-ESR tantalum capacitors (AVX part #: TPSE476M025R0100, 47µF 25V 100 mΩ ESR tantalum capacitor) will be sufficient to provide adequate ripple voltage at the input of the module. To minimize ripple voltage at the input, low ESR ceramic capacitors are recommended at the input of the module. Figure 26 shows input ripple voltage (mVp-p) for various outputs with 4x47 µF tantalum capacitors and with 4x22 µF ceramic capacitor (TDK part #: C4532X5R1C226M) at full load.

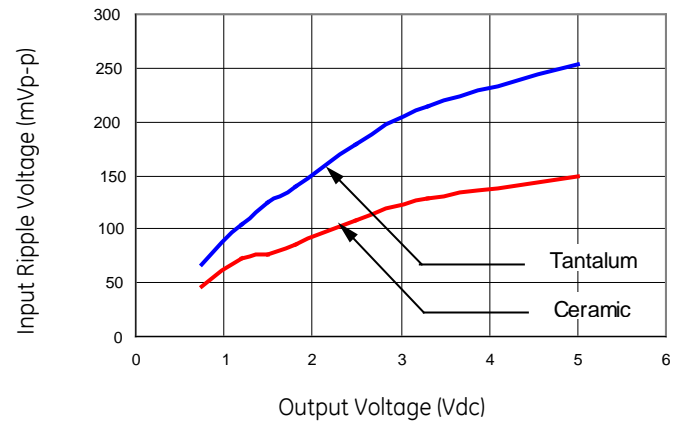

Figure 26. Input ripple voltage for various output with 4x22 µF polymer and 4x47 µF ceramic capacitors at the input (full load).

## 12V AustinLynx™10A: Non-Isolated DC-DC Power Modules, Programmable 10Vdc –14Vdc input; 0.75Vdc to 5.5Vdc output; 10A Output Current

### Design Considerations *(continued)*

#### Output Filtering

The 12V Austin Lynx Programmable SMT module is designed for low output ripple voltage and will meet the maximum output ripple specification with 1  $\mu$ F ceramic and 10  $\mu$ F tantalum capacitors at the output of the module. However, additional output filtering may be required by the system designer for a number of reasons. First, there may be a need to further reduce the output ripple and noise of the module. Second, the dynamic response characteristics may need to be customized to a particular load step change.

To reduce the output ripple and improve the dynamic response to a step load change, additional capacitance at the output can be used. Low ESR polymer and ceramic capacitors are recommended to improve the dynamic response of the module. For stable operation of the module, limit the capacitance to less than the maximum output capacitance as specified in the electrical specification table.

### Safety Considerations

For safety agency approval the power module must be installed in compliance with the spacing and separation requirements of the end-use safety agency standards, i.e., UL 60950-1, CSA C22.2 No. 60950-1-03, and VDE 0850:2001-12 (EN60950-1) Licensed.

For the converter output to be considered meeting the requirements of safety extra-low voltage (SELV), the input must meet SELV requirements. The power module has extra-low voltage (ELV) outputs when all inputs are ELV.

The input to these units is to be provided with a fast-acting fuse with a maximum rating of 15A in the positive input lead.

# 12V AustinLynx™10A: Non-Isolated DC-DC Power Modules, Programmable 10Vdc –14Vdc input; 0.75Vdc to 5.5Vdc output; 10A Output Current

## Feature Description

### Remote On/Off

The 12V Austin Lynx Programmable SMT power modules feature an On/Off pin for remote On/Off operation. If not using the remote On/Off pin, leave the pin open (module will be On). The On/Off pin signal (Von/Off) is referenced to ground. To switch the module on and off using remote On/Off, connect an open collector npn transistor between the On/Off pin and the ground pin (See Figure 27).

During a logic-high (On/Off pin is pulled high internal to the module) when the transistor is in the Off state, the power module is ON. The maximum allowable leakage current of the transistor when  $V_{on/off} = V_{IN,max}$  is 10µA. During a logic-low when the transistor is turned-on, the power module is OFF. During this state  $V_{On/Off}$  is less than 0.3V and the maximum  $I_{On/Off} = 1mA$ .

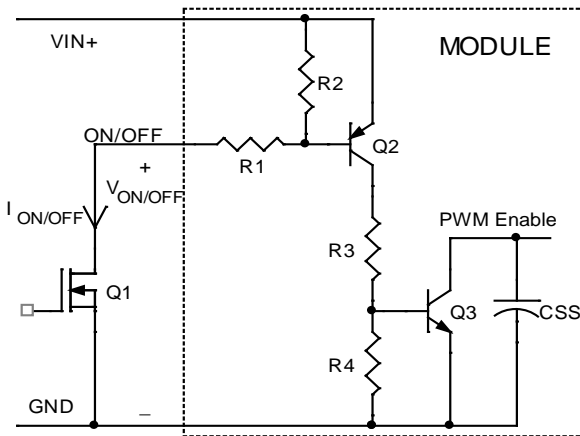

Figure 27. Remote On/Off Implementation.

### Overcurrent Protection

To provide protection in a fault (output overload) condition, the unit is equipped with internal current-limiting circuitry and can endure current limiting continuously. At the point of current-limit inception, the unit enters hiccup mode. The unit operates normally once the output current is brought back into its specified range. The typical average output current during hiccup is 3 A.

### Input Undervoltage Lockout

At input voltages below the input undervoltage lockout limit, module operation is disabled. The module will begin to operate at an input voltage above the undervoltage lockout turn-on threshold.

### Overtemperature Protection

To provide over temperature protection in a fault condition, the unit relies upon the thermal protection feature of the controller IC. The unit will shutdown if the thermal reference point  $T_{ref}$ , exceeds 125°C (typical), but the thermal shutdown is not intended as a guarantee that the unit will survive temperatures

beyond its rating. The module will automatically restart after it cools down.

### Output Voltage Programming

The output voltage of the 12V Austin Lynx Programmable SMT module can be programmed to any voltage from 0.75Vdc to 5.5Vdc by connecting a resistor (shown as  $R_{trim}$  in Figure 28) between Trim and GND pins of the module. Without an external resistor between Trim and GND pins, the output of the module will be 0.7525Vdc. To calculate the value of the trim resistor,  $R_{trim}$  for a desired output voltage, use the following equation:

$$R_{trim} = \left[ \frac{10500}{V_o - 0.7525} - 1000 \right] \Omega$$

For example, to program the output voltage of the 12V Austin Lynx Programmable SMT module to 1.8 Vdc,  $R_{trim}$  is calculated as follows:

$$R_{trim} = \left[ \frac{10500}{1.8 - 0.75} - 1000 \right]$$

$$R_{trim} = 9.024k\Omega$$

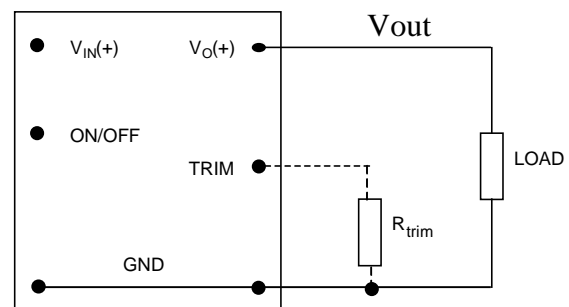

Figure 28. Circuit configuration for programming output voltage using an external resistor.

Table 1 provides  $R_{trim}$  values required for some common output voltages

Table 1

| $V_{o, set}$ (V) | $R_{trim}$ (KΩ) |
|------------------|-----------------|
| 0.7525           | Open            |
| 1.2              | 22.46           |
| 1.5              | 13.05           |
| 1.8              | 9.024           |
| 2.5              | 5.009           |
| 3.3              | 3.122           |
| 5.0              | 1.472           |

# 12V AustinLynx™10A: Non-Isolated DC-DC Power Modules, Programmable 10Vdc –14Vdc input; 0.75Vdc to 5.5Vdc output; 10A Output Current

## Feature Descriptions (continued)

By using a 1% tolerance trim resistor, set point tolerance of ±2% is achieved as specified in the electrical specification. The POL Programming Tool, available at [www.gecriticalpower.com](http://www.gecriticalpower.com) under the Design Tools section, helps determine the required external trim resistor needed for a specific output voltage.

The amount of power delivered by the module is defined as the voltage at the output terminals multiplied by the output current. When using the trim feature, the output voltage of the module can be increased, which at the same output current would increase the power output of the module. Care should be taken to ensure that the maximum output power of the module remains at or below the maximum rated power ( $P_{max} = V_{o,set} \times I_{o,max}$ ).

## Remote Sense

The 12V Austin Lynx Programmable SMT power modules have a Remote Sense feature to minimize the effects of distribution losses by regulating the voltage at the Remote Sense and GND pins (See Figure 29). The voltage between the Sense pin and  $V_o$  pin must not exceed 0.5V. Although both the Remote Sense and the TRIM features can increase the output voltage  $V_o$ , the maximum increase is not the sum of both. The maximum  $V_o$  increase is the larger of either the Remote Sense or TRIM.

The amount of power delivered by the module is defined as the output voltage multiplied by the output current ( $V_o \times I_o$ ). When using Remote Sense and/or TRIM, the output voltage of the module can increase, which if the same output is maintained, increases the power output by the module. Make sure that the maximum output power of the module remains at or below the maximum rated power. When the Remote Sense feature is not being used, leave the Remote Sense pin unconnected.

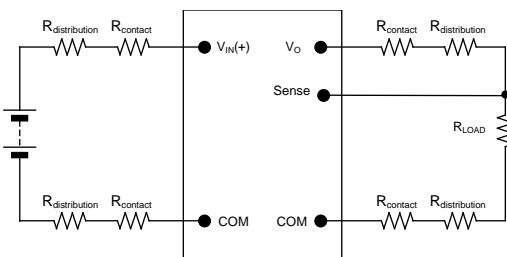

Figure 29. Remote sense circuit configuration

## Voltage Margining

Output voltage margining can be implemented in the 12V Austin Lynx Programmable SMT modules by connecting a resistor,  $R_{margin-up}$ , from Trim pin to ground pin for margining-up the output voltage and by connecting a resistor,  $R_{margin-down}$ , from Trim pin to Output pin. Figure 30 shows the circuit configuration for output voltage margining. The POL Programming Tool, available at [www.gecriticalpower.com](http://www.gecriticalpower.com)

under the Design Tools section, also calculates the values of  $R_{margin-up}$  and  $R_{margin-down}$  for a specific output voltage and % margin. Please consult your local GE technical representative for additional details

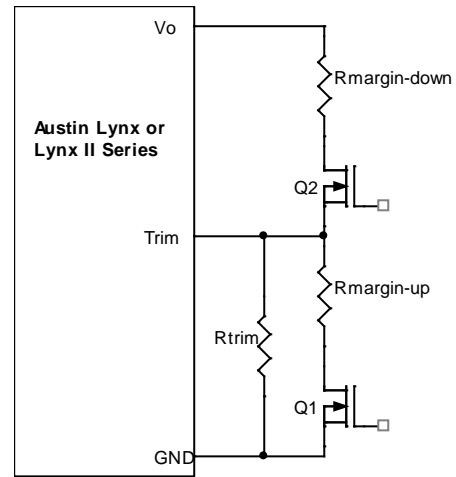

Figure 30. Circuit Configuration for margining Output voltage.

# 12V AustinLynx™10A: Non-Isolated DC-DC Power Modules, Programmable 10Vdc – 14Vdc input; 0.75Vdc to 5.5Vdc output; 10A Output Current

## Thermal Considerations

Power modules operate in a variety of thermal environments; however, sufficient cooling should always be provided to help ensure reliable operation.

Considerations include ambient temperature, airflow, module power dissipation, and the need for increased reliability. A reduction in the operating temperature of the module will result in an increase in reliability. The thermal data presented here is based on physical measurements taken in a wind tunnel. The test set-up is shown in Figure 32. Note that the airflow is parallel to the short axis of the module as shown in figure 31. The derating data applies to airflow in either direction of the module's short axis.

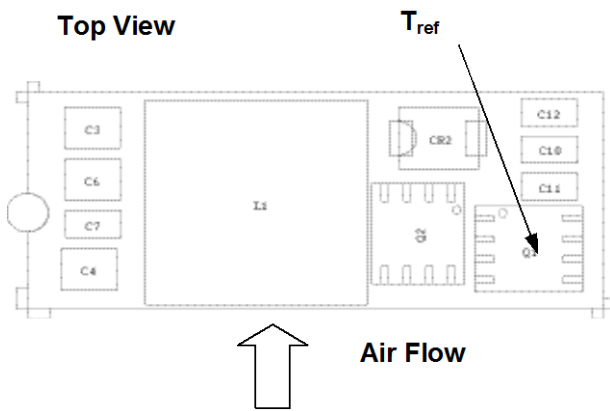

Figure 31. T<sub>ref</sub> Temperature measurement location.

The thermal reference point, T<sub>ref</sub> used in the specifications is shown in Figure 31. For reliable operation this temperature should not exceed 115°C.

The output power of the module should not exceed the rated power of the module (V<sub>o,set</sub> x I<sub>o,max</sub>).

Please refer to the Application Note “Thermal Characterization Process For Open-Frame Board-Mounted Power Modules” for a detailed discussion of thermal aspects including maximum device temperatures.

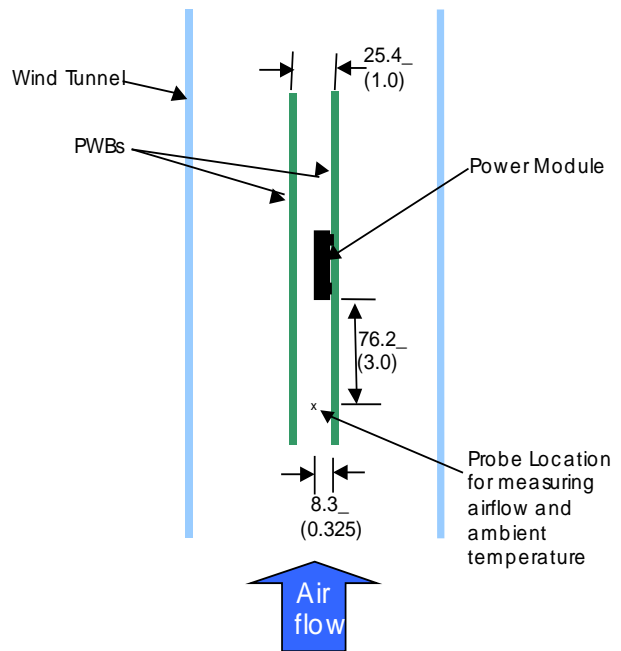

Figure 32. Thermal Test Set-up.

## Heat Transfer via Convection

Increased airflow over the module enhances the heat transfer via convection. Thermal derating curves showing the maximum output current that can be delivered at different local ambient temperatures (T<sub>A</sub>) for airflow conditions ranging from natural convection and up to 2m/s (400 ft./min) are shown in the Characteristics Curves section.

# 12V AustinLynx™10A: Non-Isolated DC-DC Power Modules, Programmable

10Vdc – 14Vdc input; 0.75Vdc to 5.5Vdc output; 10A Output Current

## Mechanical Outline

Dimensions are in millimeters and (inches).

Tolerances: x.x mm ± 0.5 mm (x.xx in. ± 0.02 in.) [unless otherwise indicated]

x.xx mm ± 0.25 mm (x.xxx in ± 0.010 in.)

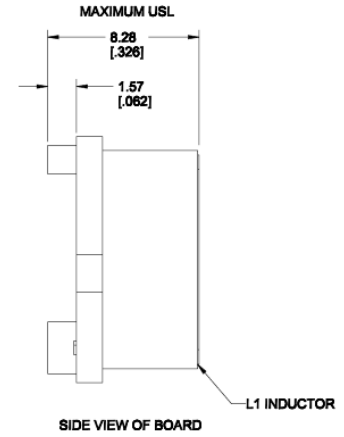
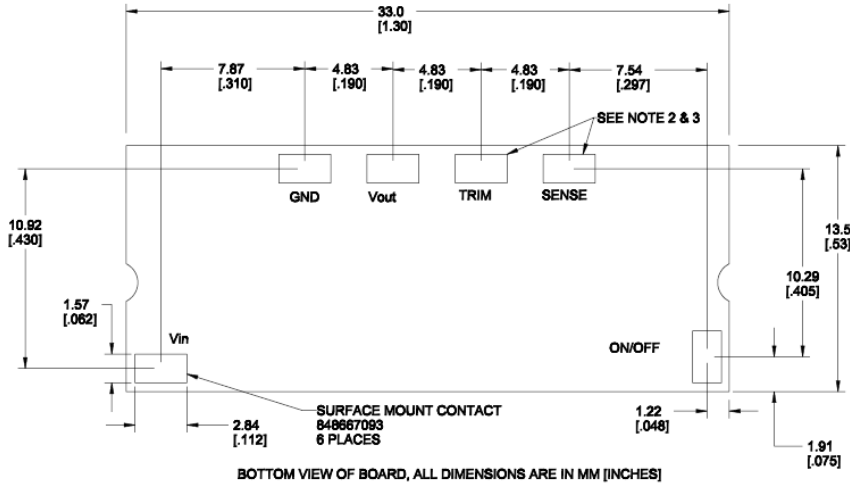

# 12V AustinLynx™10A: Non-Isolated DC-DC Power Modules, Programmable

10Vdc –14Vdc input; 0.75Vdc to 5.5Vdc output; 10A Output Current

## Recommended Pad Layout

Dimensions are in millimeters and (inches).

Tolerances: x.x mm ± 0.5 mm (x.xx in. ± 0.02 in.) [unless otherwise indicated]

x.xx mm ± 0.25 mm (x.xxx in ± 0.010 in.)

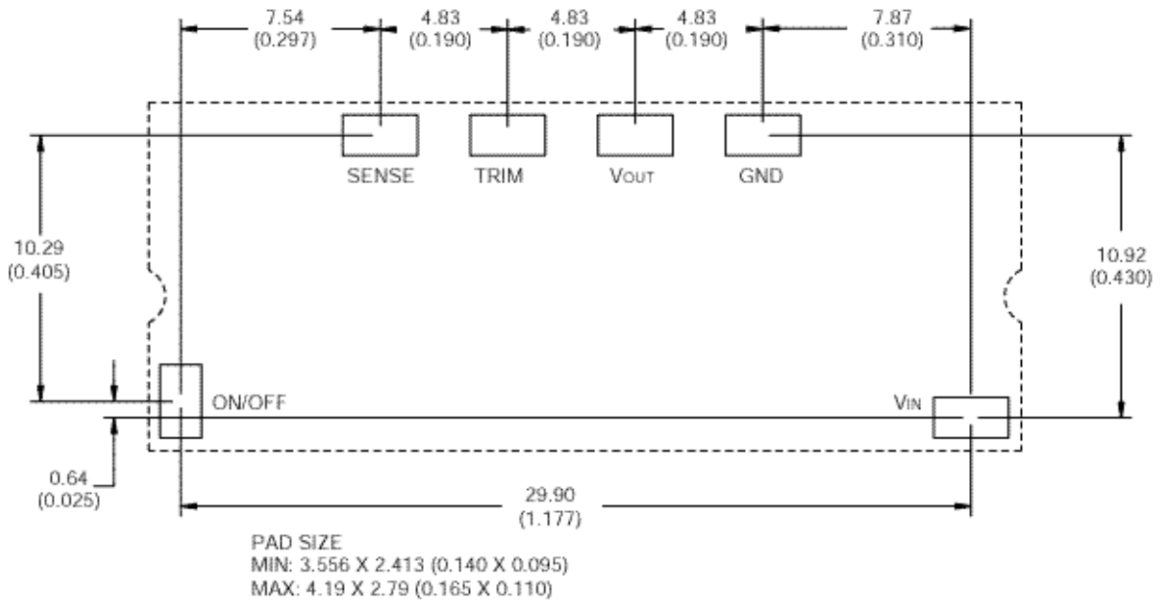



# 12V AustinLynx™10A: Non-Isolated DC-DC Power Modules, Programmable 10Vdc –14Vdc input; 0.75Vdc to 5.5Vdc output; 10A Output Current

## Packaging Details

The 12V Austin Lynx Programmable SMT version is supplied in tape & reel as standard. Modules are shipped in quantities of 250 modules per reel.

All Dimensions are in millimeters and (in inches).

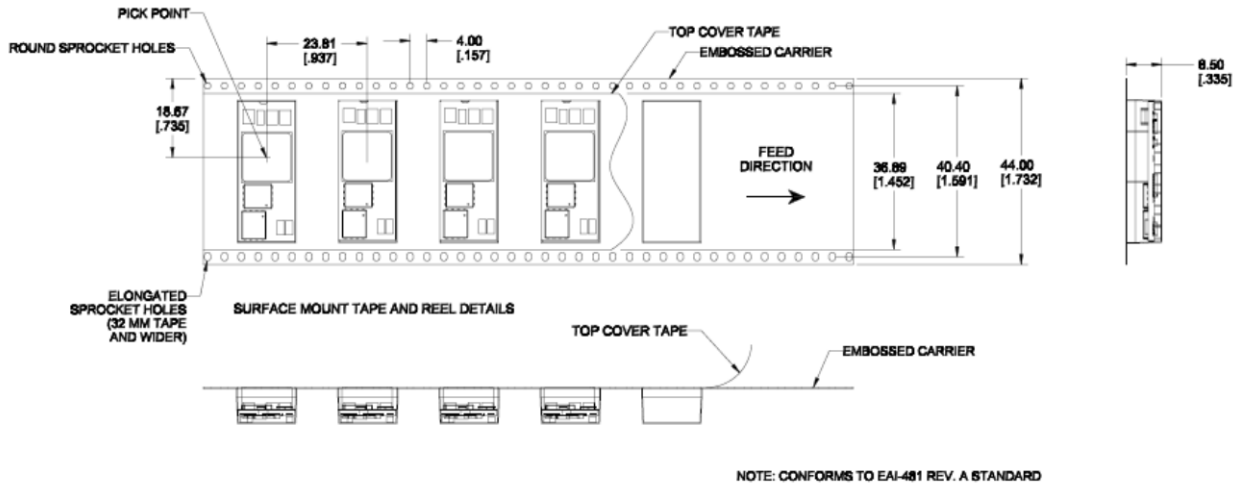

Reel Dimensions:

Outside Dimensions: 330.2 mm (13.00)

Inside Dimensions: 177.8 mm (7.00")

Tape Width: 44.00 mm (1.732")

# 12V AustinLynx™10A: Non-Isolated DC-DC Power Modules, Programmable 10Vdc –14Vdc input; 0.75Vdc to 5.5Vdc output; 10A Output Current

## Surface Mount Information

### Pick and Place

The 12V Austin Lynx Programmable SMT modules use an open frame construction and are designed for a fully automated assembly process. The modules are fitted with a label designed to provide a large surface area for pick and place operations. The label meets all the requirements for surface mount processing, as well as safety standards, and is able to withstand reflow temperatures of up to 300°C. The label also carries product information such as product code, serial number and the location of manufacture.

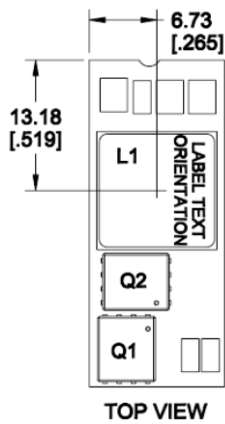

Figure 33. Pick and Place Location.

### Nozzle Recommendations

The module weight has been kept to a minimum by using open frame construction. Even so, these modules have a relatively large mass when compared to conventional SMT components. Variables such as nozzle size, tip style, vacuum pressure and placement speed should be considered to optimize this process. The minimum recommended nozzle diameter for reliable operation is 6mm. The maximum nozzle outer diameter, which will safely fit within the allowable component spacing, is 9 mm.

Oblong or oval nozzles up to 11 x 9 mm may also be used within the space available.

### Tin Lead Soldering

The Austin Lynx™ 12 V SMT power modules are lead free modules and can be soldered either in a lead-free solder process or in a conventional Tin/Lead (Sn/Pb) process. It is recommended that the customer review data sheets in order to customize the solder reflow profile for each application board assembly. The following instructions must be observed when soldering these units. Failure to observe these instructions may result in the failure of or cause damage to the modules, and can adversely affect long-term reliability.

In a conventional Tin/Lead (Sn/Pb) solder process peak reflow temperatures are limited to less than 235°C.

Typically, the eutectic solder melts at 183°C, wets the land, and subsequently wicks the device connection. Sufficient time must be allowed to fuse the plating on the connection to ensure a reliable solder joint. There are several types of SMT reflow technologies currently used in the industry. These surface mount power modules can be reliably soldered using natural forced convection, IR (radiant infrared), or a combination of convection/IR. For reliable soldering the solder reflow profile should be established by accurately measuring the modules CP connector temperatures.

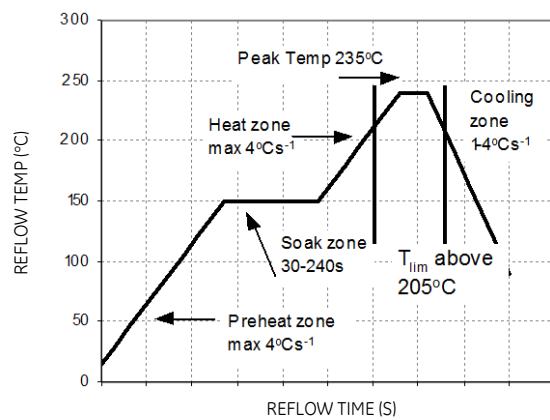

Figure 34. Reflow Profile for Tin/Lead (Sn/Pb) process.

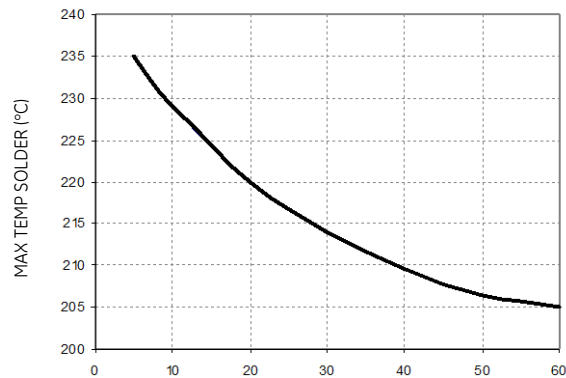

Figure 35. Time Limit Curve Above 205°C for Tin/Lead (Sn/Pb) process.

# 12V AustinLynx™10A: Non-Isolated DC-DC Power Modules, Programmable 10Vdc –14Vdc input; 0.75Vdc to 5.5Vdc output; 10A Output Current

## Surface Mount Information (continued)

### Lead Free Soldering

The -Z version 12V Austin Lynx Programmable SMT modules are lead-free (Pb-free) and RoHS compliant and are both forward and backward compatible in a Pb-free and a SnPb soldering process. Failure to observe the instructions below may result in the failure of or cause damage to the modules and can adversely affect long-term reliability.

### Pb-free Reflow Profile

Power Systems will comply with J-STD-020 Rev. C (Moisture/Reflow Sensitivity Classification for Nonhermetic Solid State Surface Mount Devices) for both Pb-free solder profiles and MSL classification procedures. This standard provides a recommended forced-air-convection reflow profile based on the volume and thickness of the package (table 4-2). The suggested Pb-free solder paste is Sn/Ag/Cu (SAC). The recommended linear reflow profile using Sn/Ag/Cu solder is shown in Fig. 36.

### MSL Rating

The 12V Austin Lynx Programmable SMT modules have a MSL rating of 2a.

### Storage and Handling

The recommended storage environment and handling procedures for moisture-sensitive surface mount packages is detailed in J-STD-033 Rev. A (Handling, Packing, Shipping and Use of Moisture/Reflow Sensitive Surface Mount Devices). Moisture barrier bags (MBB) with desiccant are required for MSL ratings of 2 or greater. These sealed packages should not be broken until time of use. Once the original package is broken, the floor life of the product at conditions of  $\leq 30^{\circ}\text{C}$  and 60% relative humidity varies according to the MSL rating (see J-STD-033A). The shelf life for dry packed SMT packages will be a minimum of 12 months from the bag seal date, when stored at the following conditions:  $< 40^{\circ}\text{C}$ ,  $< 90\%$  relative humidity.

### Post Solder Cleaning and Drying Considerations

Post solder cleaning is usually the final circuit-board assembly process prior to electrical board testing. The result of inadequate cleaning and drying can affect both the reliability of a power module and the testability of the finished circuit-board assembly. For guidance on appropriate soldering, cleaning and drying procedures, refer to *Board Mounted Power Modules: Soldering and Cleaning* Application Note (AN04-001).

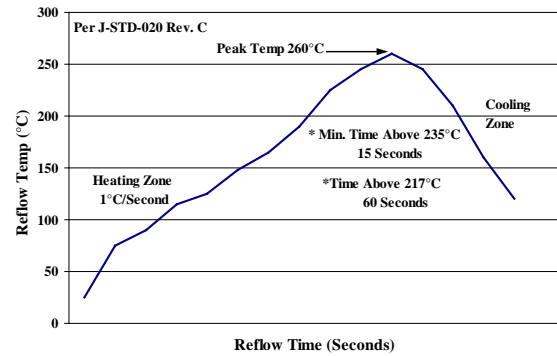

Figure 36. Recommended linear reflow profile using Sn/Ag/Cu solder.

## 12V AustinLynx™10A: Non-Isolated DC-DC Power Modules, Programmable 10Vdc – 14Vdc input; 0.75Vdc to 5.5Vdc output; 10A Output Current

### Ordering Information

Please contact your GE Sales Representative for pricing, availability and optional features.

**Table 2. Device Codes**

| Device Code    | Input Voltage | Output Voltage | Output Current | Efficiency | Connector Type | Comcodes    |
|----------------|---------------|----------------|----------------|------------|----------------|-------------|
| AXA010A0X3-SR  | 10 – 14Vdc    | 0.75 – 5.5 V   | 10 A           | 93%        | SMT            | 108970138   |
| AXA010A0X3-SRZ | 10 – 14Vdc    | 0.75 – 5.5 V   | 10 A           | 93%        | SMT            | CC109101326 |

-Z refers to RoHS-compliant versions



## Contact Us

For more information, call us at

USA/Canada:

**+1 877 546 3243**, or +1 972 244 9288

Asia-Pacific:

+86.021.54279977\*808

Europe, Middle-East and Africa:

+49.89.878067-280

[www.gecriticalpower.com](http://www.gecriticalpower.com)

GE Critical Power reserves the right to make changes to the product(s) or information contained herein without notice, and no liability is assumed as a result of their use or application. No rights under any patent accompany the sale of any such product(s) or information.