

DO NOT SCALE FROM THIS PRINT

TABLE 1		
LEAD STYLE	"A"	"B"
-02	.075 [1.91] $\text{\textcircled{C}}$	0.075
-03	.065 [1.65] $\text{\textcircled{C}}$	0.055

No OF POS PER ROW
-02 THRU -50
(SEE NOTE 10)

LEAD STYLE
-02: .075 [1.91]
(USE T-1S16-03-XX-2)
-03: .065 [1.65]
(USE T-1S16-04-XX-2)

PLATING SPECIFICATION
-L: 10 μ " LIGHT SELECTIVE GOLD IN CONTACT AREA, MATTE TIN ON TAIL
-F: 3 μ " FLASH SELECTIVE GOLD IN CONTACT AREA, MATTE TIN ON TAIL
-H: 30 μ " HEAVY GOLD IN CONTACT AREA, 3 μ " FLASH GOLD ON TAIL
-G: 10 μ " GOLD IN CONTACT AREA, 3 μ " FLASH GOLD ON TAIL
-LM: 10 μ " LIGHT SELECTIVE GOLD IN CONTACT AREA, MATTE TIN ON TAIL
-FM: 3 μ " FLASH SELECTIVE GOLD IN CONTACT AREA, MATTE TIN ON TAIL

OPTIONS
-P: PICK & PLACE PAD (USE PPP-30)
(USE PPP-30-NT FOR TAPE & REEL)
(SEE FIG 3, SHT 4: 6 POS MIN)
-TR: TAPE & REEL PACKAGING
-ES: SNAP ON END SHROUDS
(SEE FIG 2, SHT 2: 9 POS MIN)
MOLD TO POSITION END SHROUDS
(5 POS MIN; SEE FIG 2, SHT 2)
(SAMTEC DISCRETION ON WHICH END SHROUDS ARE USED FOR POSITIONS -09 AND GREATER)
-EP: GUIDE POST (SEE FIG 4, SHT 4: 9 POS MIN)
(USE ONLY WHEN MATING WITH A CLM)
-EC: LOCKING CLIP (SEE FIG 5, SHT 4)
(SEE NOTE 9; 9 POS MIN)
-A: ALIGNMENT PIN (SEE FIG 6 & 7, SHT 5)
(SAMTEC DISCRETION ON WHICH -A PIN IS USED)
(MOLDED: 3 POS MIN, USE FTMH-75-D-XX)
(STAKED: 7 POS MIN, USE FTMH-60-D)

ROW SPECIFICATION
-DV: DOUBLE ROW VERTICAL
(USE FTMH-75-D)

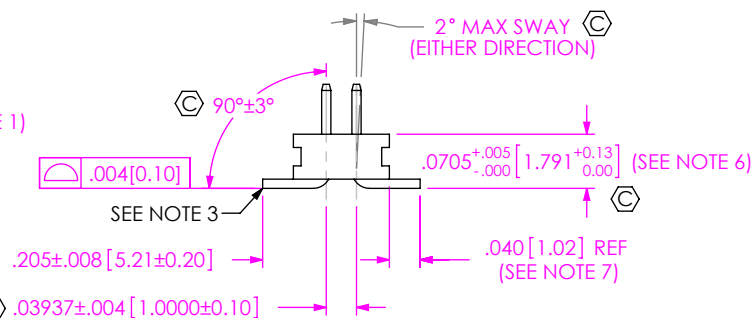
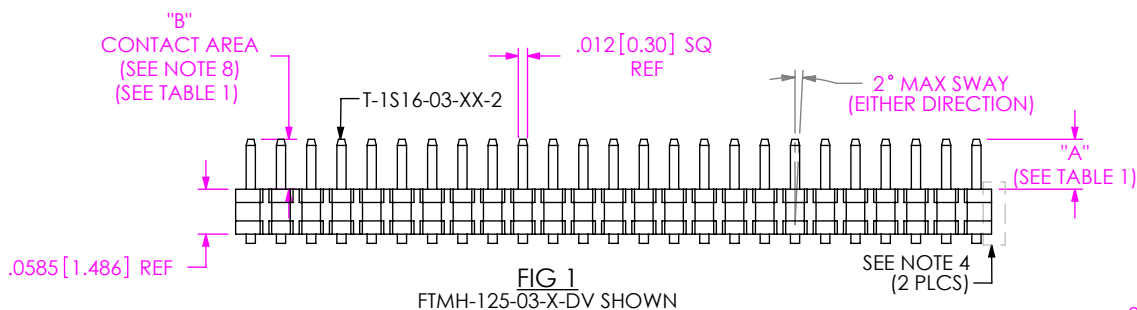
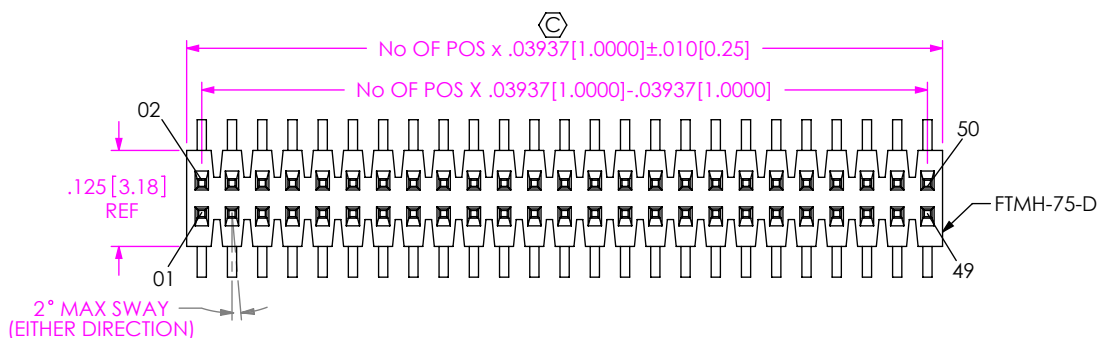

NOTES:

- $\text{\textcircled{C}}$ REPRESENTS CRITICAL DIMENSION.
- MINIMUM PUSHOUT FORCE: 1.0 LB = 16 OZ.
- MAXIMUM BURR: .003 [0.08]
- MAXIMUM CUT FLASH: .010 [0.25]
- POSITIONS -02 THRU -04 TO BE LAYER PACKAGED.
- MEASURED AT BEND RADIUS.
- SHEAR TAILS TO DIMENSION SHOWN.
- FOR SELECTIVE PLATING OPTIONS, GOLD PLATING TO BE ON POST, TIN PLATING TO BE ON TAIL.
- DUE TO THE HIGH AMOUNT OF INSERTION FORCE NEEDED, THE -EC OPTION IS NOT COMPATIBLE WITH AUTO PLACEMENT. SAMTEC RECOMMENDS MANUAL PLACEMENT FOR ALL ASSEMBLIES WITH THE -EC OPTION.
- NUMBER OF POSITIONS MAY BE AS HIGH AS -75 FOR SAMTEC MANUFACTURING ONLY.

UNLESS OTHERWISE SPECIFIED, DIMENSIONS ARE IN INCHES.

TOLERANCES ARE:

DECIMALS ANGLES
.XX: ± .01 [0.3]
.XXX: ± .005 [0.13]
.XXXX: ± .0020 [0.051]

PROPRIETARY NOTE

THIS DOCUMENT CONTAINS CONFIDENTIAL AND PROPRIETARY INFORMATION AND ALL DESIGN, MANUFACTURING, REPRODUCTION, USE, PATENT RIGHTS AND SALES RIGHTS ARE EXPRESSLY RESERVED BY SAMTEC, INC. THIS DOCUMENT SHALL NOT BE DISCLOSED, IN WHOLE OR PART, TO ANY UNAUTHORIZED PERSON OR ENTITY NOR REPRODUCED, TRANSFERRED OR INCORPORATED IN ANY OTHER PROJECT IN ANY MANNER WITHOUT THE EXPRESS WRITTEN CONSENT OF SAMTEC, INC.



520 PARK EAST BLVD, NEW ALBANY, IN 47150
PHONE: 812-944-6733 FAX: 812-948-5047
e-Mail: info@SAMTEC.com code: 55322

MATERIAL DO NOT SCALE DRAWING SHEET SCALE: 5:1

INSULATOR: BLACK, LCP, UL-94-V-0
TERMINAL: PHOSPHOR BRONZE

DESCRIPTION: 1mm x 1mm DOUBLE VERTICAL SMT TERMINAL STRIP

DWG. NO. FTMH-1XX-XX-XX-DV-XX

BY: PURVIS 04/22/96 SHEET 1 OF 5

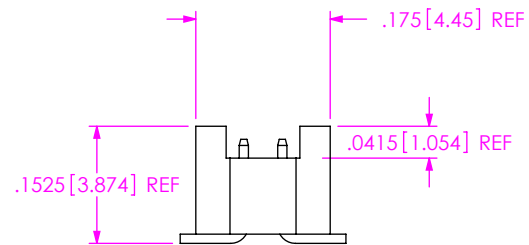
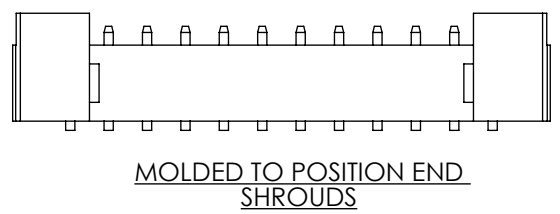
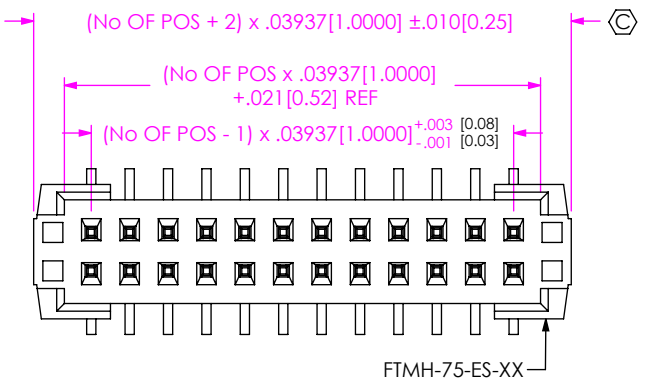
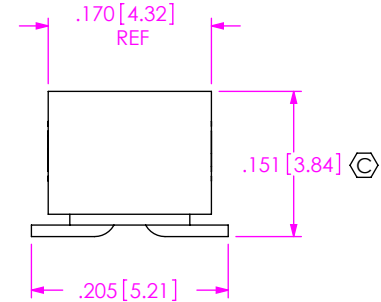
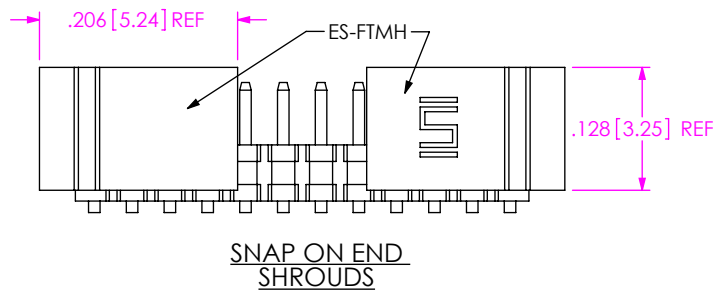
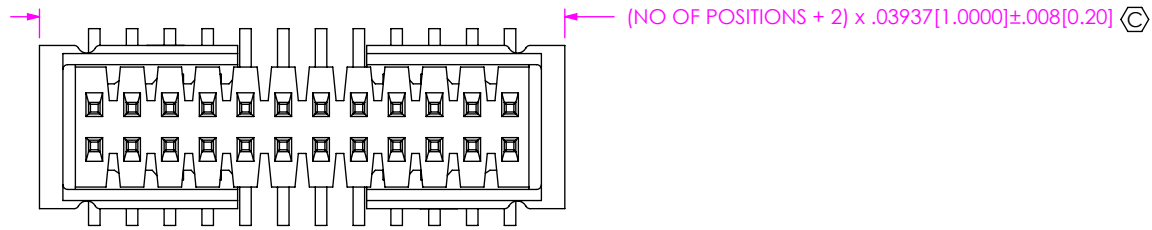

FIG 2
-ES: END SHROUDS
FTMH-112-02-X-DV-ES SHOWN
(DIFFERENT AS SHOWN, OTHERWISE SAME AS FIG 1)

PROPRIETARY NOTE
THIS DOCUMENT CONTAINS CONFIDENTIAL AND PROPRIETARY INFORMATION AND ALL DESIGN, MANUFACTURING, REPRODUCTION, USE, PATENT RIGHTS AND SALES RIGHTS ARE EXPRESSLY RESERVED BY SAMTEC, INC. THIS DOCUMENT SHALL NOT BE DISCLOSED, IN WHOLE OR PART, TO ANY UNAUTHORIZED PERSON OR ENTITY NOR REPRODUCED, TRANSFERRED OR INCORPORATED IN ANY OTHER PROJECT IN ANY MANNER WITHOUT THE EXPRESS WRITTEN CONSENT OF SAMTEC, INC.

DO NOT SCALE DRAWING

SHEET SCALE: 5:1



DESCRIPTION:
1mm x 1mm DOUBLE VERTICAL SMT TERMINAL STRIP

DWG. NO.
FTMH-1XX-XX-XX-DV-XX

BY: PURVIS 04/22/96 SHEET 2 OF 5

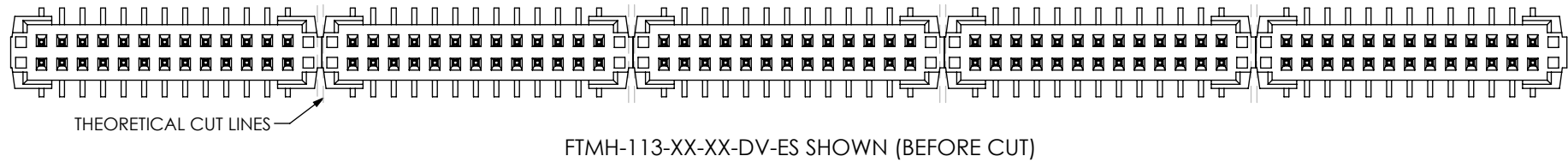
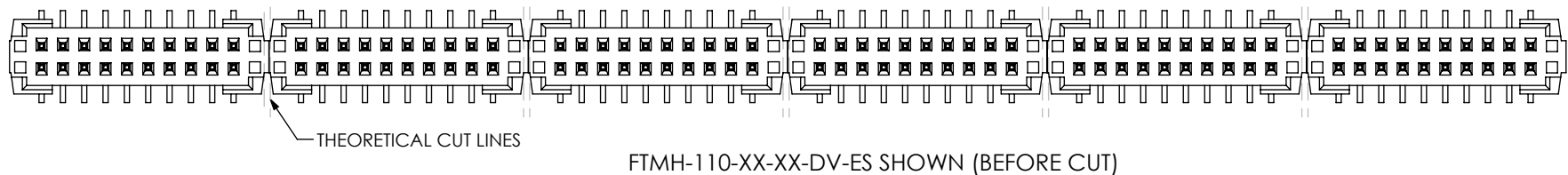
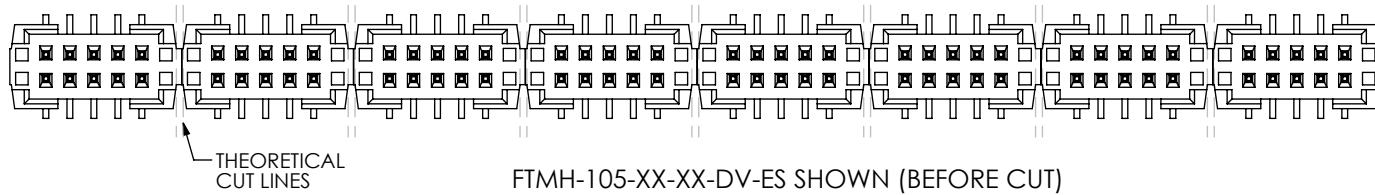

PROPRIETARY NOTE
 * THIS DOCUMENT CONTAINS CONFIDENTIAL AND PROPRIETARY INFORMATION AND ALL DESIGN, MANUFACTURING, REPRODUCTION, USE, PATENT RIGHTS AND SALES RIGHTS ARE EXPRESSLY RESERVED BY SAMTEC, INC. THIS DOCUMENT SHALL NOT BE DISCLOSED, IN WHOLE OR PART, TO ANY UNAUTHORIZED PERSON OR ENTITY NOR REPRODUCED, TRANSFERRED OR INCORPORATED IN ANY OTHER PROJECT IN ANY MANNER WITHOUT THE EXPRESS WRITTEN CONSENT OF SAMTEC, INC. *

DO NOT SCALE DRAWING
 SHEET SCALE: 5:1



520 PARK EAST BLVD, NEW ALBANY, IN 47150
 PHONE: 812-944-6733 FAX: 812-948-5047
 e-Mail: info@SAMTEC.com code: 55322

DESCRIPTION:	1mm x 1mm DOUBLE VERTICAL SMT TERMINAL STRIP
DWG. NO.	FTMH-1XX-XX-XX-DV-XX
BY: PURVIS	04/22/96
	SHEET 3 OF 5

NOTE
 "M" = USED MEASURED DIMENSION (REF)
 "P" = $(("M" - .200[5.08]) / 2) \pm .020[.51]$

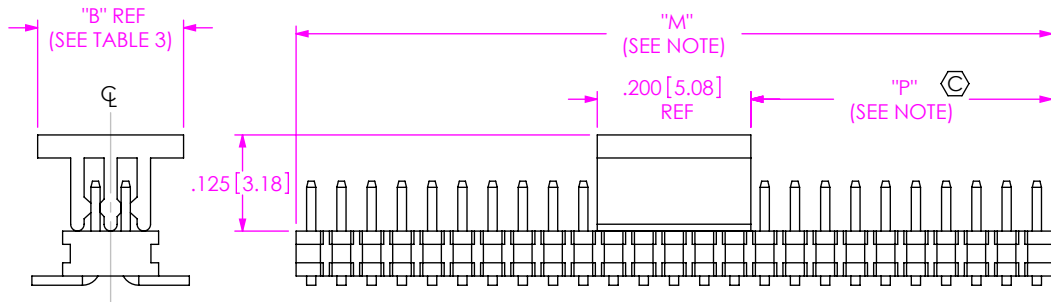

FIG 3
 -P: PICK & PLACE PAD
 FTMH-125-03-X-DV-P SHOWN
 (DIFFERENT AS SHOWN, OTHERWISE SAME AS FIG 1)

TABLE 3	
PAD	"B"
PPP-30	.125[3.18]
PPP-30-NT	.190[4.83]

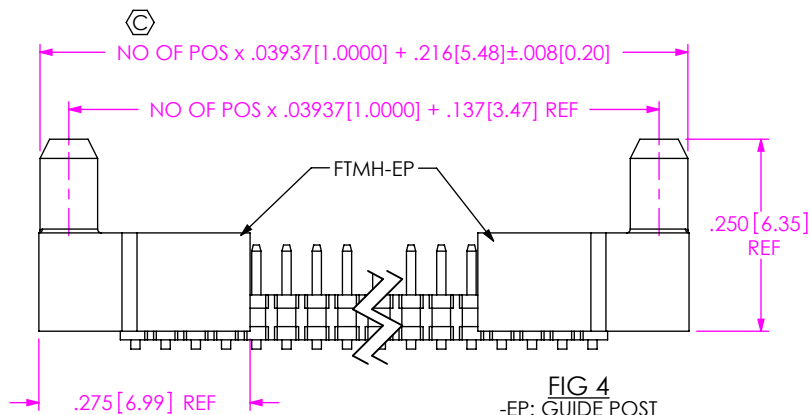

FIG 4
 -EP: GUIDE POST
 FTMH-125-03-X-DV-EP SHOWN
 (DIFFERENT AS SHOWN, OTHERWISE SAME AS FIG 1)

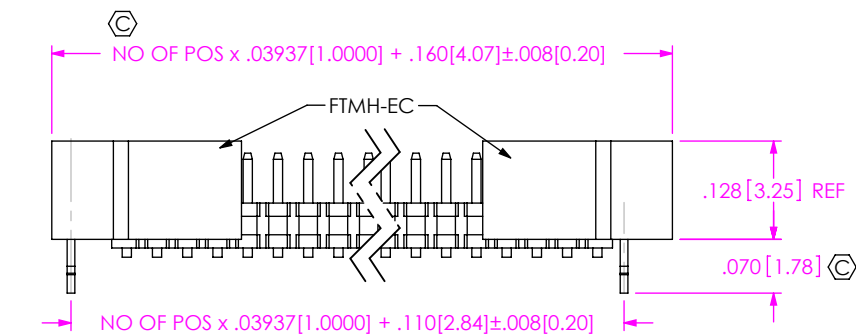
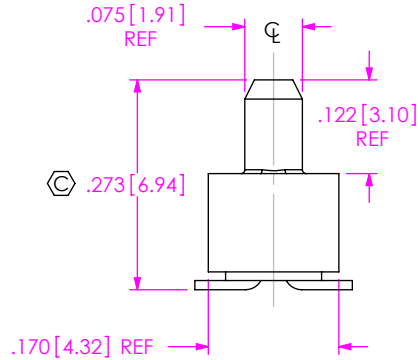
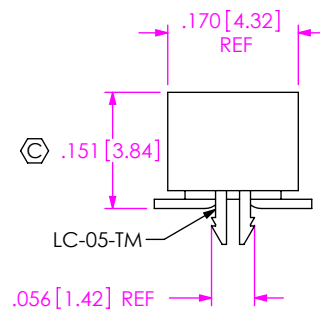

FIG 5
 -EC: LOCKING CLIP
 FTMH-125-03-X-DV-EC SHOWN
 (DIFFERENT AS SHOWN, OTHERWISE SAME AS FIG 1)



PROPRIETARY NOTE
 THIS DOCUMENT CONTAINS CONFIDENTIAL AND PROPRIETARY INFORMATION AND ALL DESIGN, MANUFACTURING, REPRODUCTION, USE, PATENT RIGHTS AND SALES RIGHTS ARE EXPRESSLY RESERVED BY SAMTEC, INC. THIS DOCUMENT SHALL NOT BE DISCLOSED, IN WHOLE OR PART, TO ANY UNAUTHORIZED PERSON OR ENTITY NOR REPRODUCED, TRANSFERRED OR INCORPORATED IN ANY OTHER PROJECT IN ANY MANNER WITHOUT THE EXPRESS WRITTEN CONSENT OF SAMTEC, INC.

DO NOT SCALE DRAWING

SHEET SCALE: 5:1



520 PARK EAST BLVD, NEW ALBANY, IN 47150
 PHONE: 812-944-6733 FAX: 812-948-5047
 e-Mail: info@SAMTEC.com code: 55322

DESCRIPTION:
 1mm x 1mm DOUBLE VERTICAL SMT TERMINAL STRIP

DWG. NO.
FTMH-1XX-XX-XX-DV-XX

BY: PURVIS 04/22/96 SHEET 4 OF 5

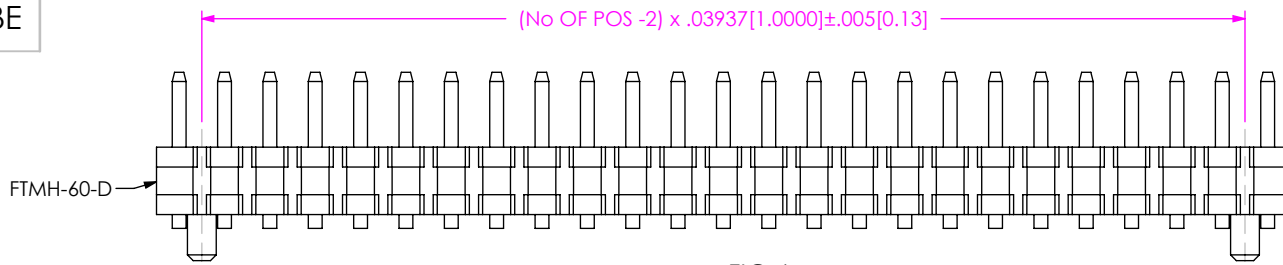

FTMH-60-D

FIG 6
 -A: ALIGNMENT PIN (STAKED)
 (MIN 7 POSITIONS)
 FTMH-125-03-X-DV-A SHOWN
 (DIFFERENT AS SHOWN, OTHERWISE SAME AS FIG 1)

⊕ .028 [0.71]

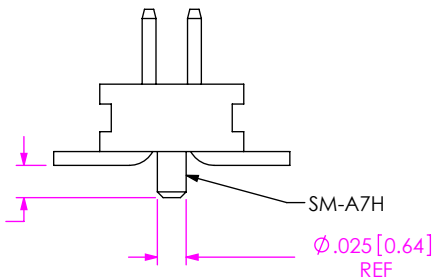

SM-A7H

∅.025 [0.64] REF

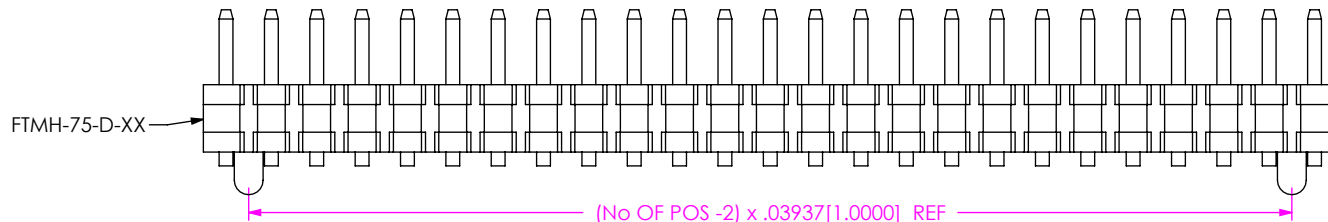

FTMH-75-D-XX

FIG 7
 -A: ALIGNMENT PIN (MOLDED)
 (MIN 3 POSITIONS)
 FTMH-125-03-X-DV-A SHOWN
 (DIFFERENT AS SHOWN, OTHERWISE SAME AS FIG 1)

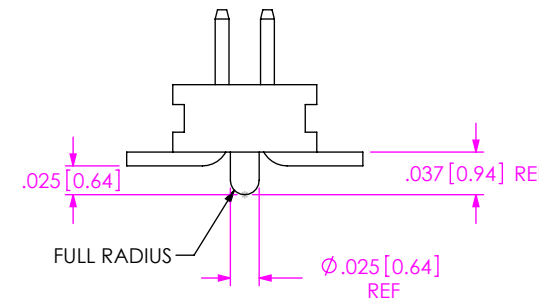

FULL RADIUS

∅.025 [0.64] REF

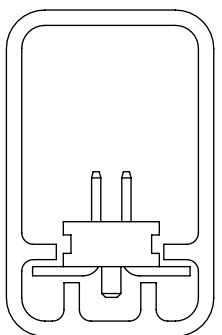

-A OPTION
 PT-1-24-01-60

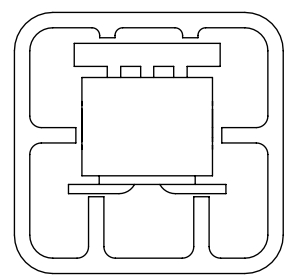

-ES-P OPTION
 PT-1-24-01-63

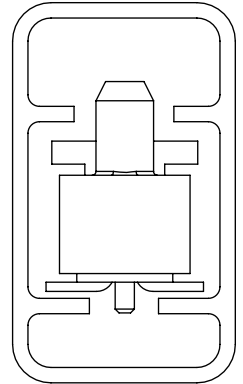

-EP-A-P OPTION
 PT-1-24-02-15

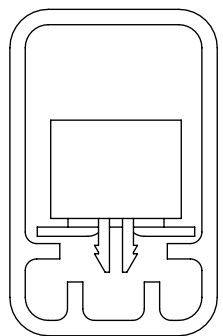

-EC OPTION
 PT-1-24-01-60 **BE**

PACKAGING VIEWS

TABLE 2
(SEE NOTE 5 FOR PACKAGING NOTES)

LEAD STYLE	OPTION (S)	PACKAGING TUBE	TUBE PLUG
-02, -03	-NONE	PT-1-24-01-60	TP-03 (x 2)
-02, -03	-A	PT-1-24-01-60	TP-03 (x 2)
-02, -03	-P, -A-P	PT-1-24-01-60	TP-03 (x 2)
-02, -03	-ES, -ES-P, -ES-A, EP	PT-1-24-01-63	TP-24 (x 2)
-02, -03	-EC, -EC-P, -EC-A	PT-1-24-01-60	TP-03 (x 2)
-02, -03	-EP-A, -EP-A-P	PT-1-24-02-15	TP-03 (x 2)

PROPRIETARY NOTE
 THIS DOCUMENT CONTAINS CONFIDENTIAL AND PROPRIETARY INFORMATION AND ALL DESIGN, MANUFACTURING, REPRODUCTION, USE, PATENT RIGHTS AND SALES RIGHTS ARE EXPRESSLY RESERVED BY SAMTEC, INC. THIS DOCUMENT SHALL NOT BE DISCLOSED, IN WHOLE OR PART, TO ANY UNAUTHORIZED PERSON OR ENTITY NOR REPRODUCED, TRANSFERRED OR INCORPORATED IN ANY OTHER PROJECT IN ANY MANNER WITHOUT THE EXPRESS WRITTEN CONSENT OF SAMTEC, INC.

DO NOT SCALE DRAWING

SHEET SCALE: 5:1



520 PARK EAST BLVD, NEW ALBANY, IN 47150
 PHONE: 812-944-6733 FAX: 812-948-5047
 e-Mail: info@SAMTEC.com code: 55322

DESCRIPTION:
 1mm x 1mm DOUBLE VERTICAL SMT TERMINAL STRIP

DWG. NO. **FTMH-1XX-XX-XX-DV-XX**

BY: PURVIS 04/22/96 SHEET 5 OF 5