

WINNIE-O

~60° 20° oval beam. Holder with 35 mm screw hole distance according to Zhaga standard. Compatible with Bender Wirth 4xx Typ L5 connector.

TECHNICAL SPECIFICATIONS:

Dimensions	Ø 49.8 mm
Height	19.3 mm
Fastening	screw
Colour	white
Box size	
Box weight	0 kg
Quantity in Box	364 pcs
ROHS compliant	yes ⓘ



MATERIAL SPECIFICATIONS:

Component	Type	Material	Colour
WINNIE-O	Lens	PMMA	clear
WINNIE-HOLDER	Holder	PC	white

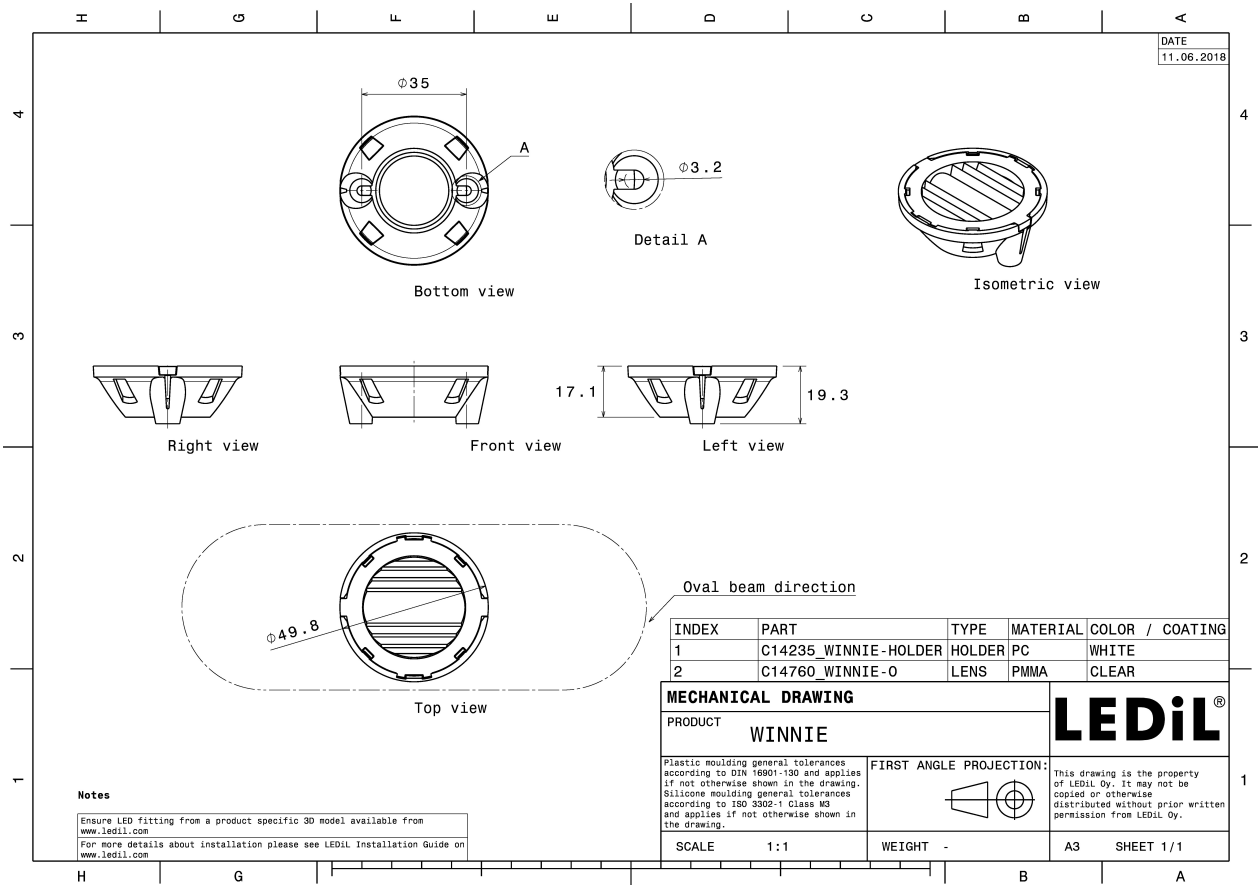

PHOTOMETRIC DATA (MEASURED):

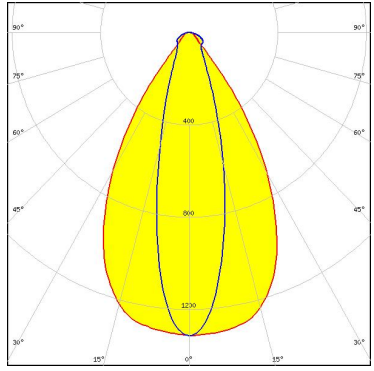
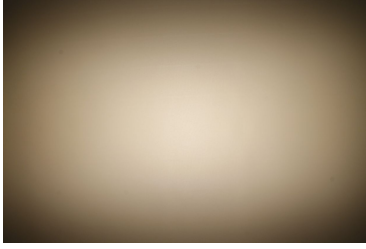
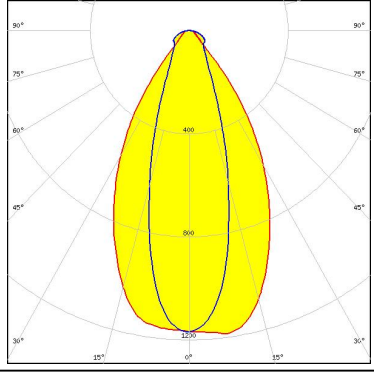
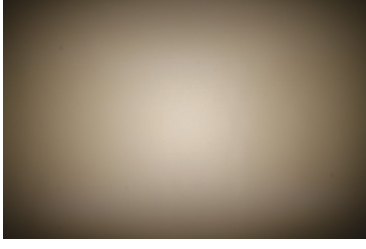
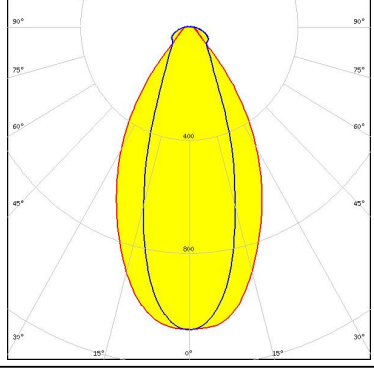
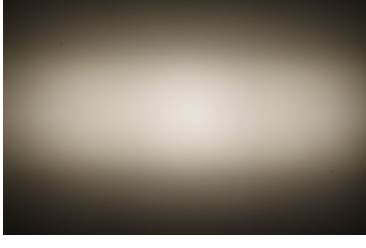
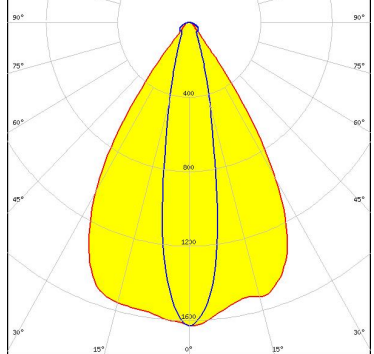
<p>bridgelux.</p> <p>LED V13 Gen6 FWHM 62.0 + 27.0° Efficiency 88 % Peak intensity 1.300 cd/lm Required components:</p>		
<p>bridgelux.</p> <p>LED V15 Gen6 FWHM 59.0 + 31.0° Efficiency 89 % Peak intensity 1.200 cd/lm Required components:</p>		
<p>bridgelux.</p> <p>LED V18 Gen6 FWHM 57.0 + 35.0° Efficiency 89 % Peak intensity 1.100 cd/lm Required components:</p>		
<p>bridgelux.</p> <p>LED V8 Gen6 FWHM 65.0 + 21.0° Efficiency 89 % Peak intensity 1.600 cd/lm Required components:</p>		

PHOTOMETRIC DATA (MEASURED):

CITIZEN

LED CLL02x/CLU02x (LES10)
 FWHM 63.0 + 22.0°
 Efficiency 90 %
 Peak intensity 1.600 cd/lm
 Required components:
 Bender Wirth: 434 Typ L5

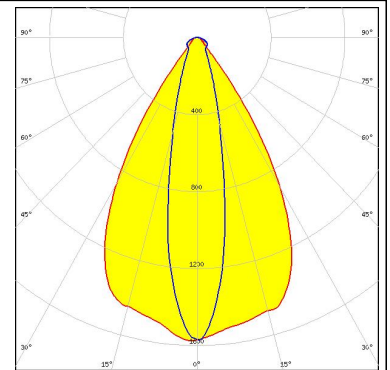
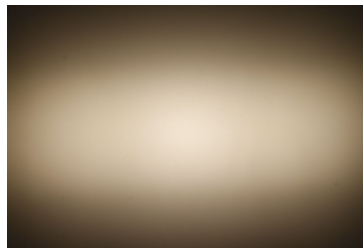

CITIZEN

LED CLL03x/CLU03x
 FWHM 59.0 + 29.0°
 Efficiency 90 %
 Peak intensity 1.200 cd/lm
 Required components:
 Bender Wirth: 433 Typ L5

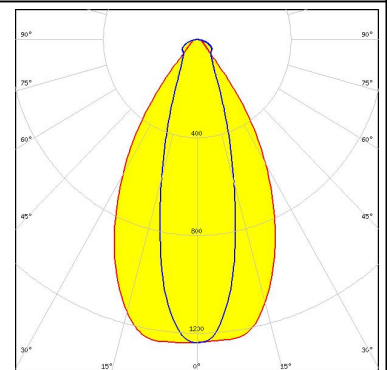
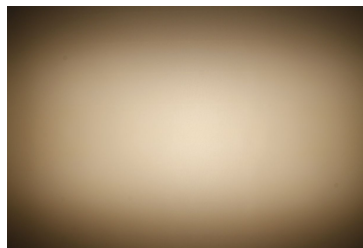

CITIZEN

LED CLU700/701
 FWHM 64.0 + 18.0°
 Efficiency 91 %
 Peak intensity 1.800 cd/lm
 Required components:

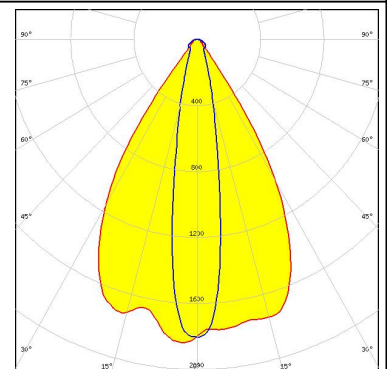
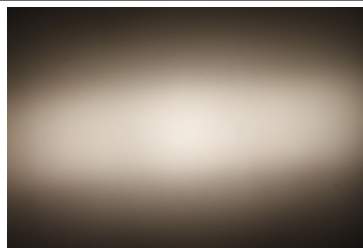

CITIZEN

LED CLU710/711
 FWHM 63.0 + 20.0°
 Efficiency 91 %
 Peak intensity 1.700 cd/lm
 Required components:
 Bender Wirth: 470 Typ L5

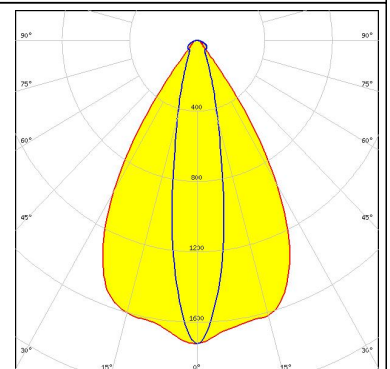
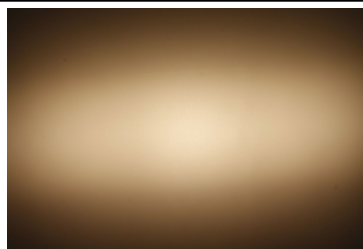

PHOTOMETRIC DATA (MEASURED):

CITIZEN

LED CLU720/721
 FWHM 61.0 + 23.0°
 Efficiency 90 %
 Peak intensity 1.500 cd/lm
 Required components:
 Bender Wirth: 433 Typ L5

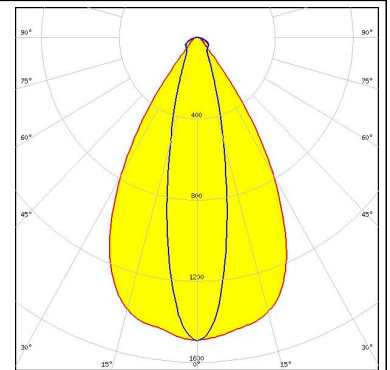
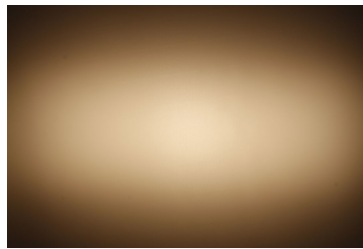

CREE

LED CXA/B 13xx
 FWHM 66.0 + 20.0°
 Efficiency 90 %
 Peak intensity 1.700 cd/lm
 Required components:

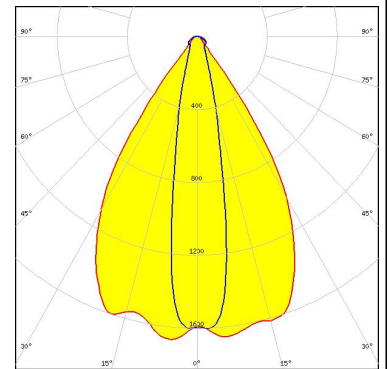
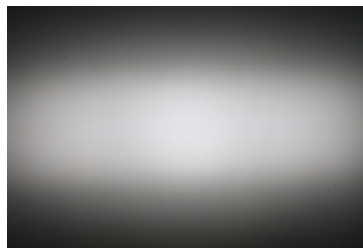

CREE

LED CXA/B 15xx
 FWHM 65.0 + 23.0°
 Efficiency 89 %
 Peak intensity 1.500 cd/lm
 Required components:

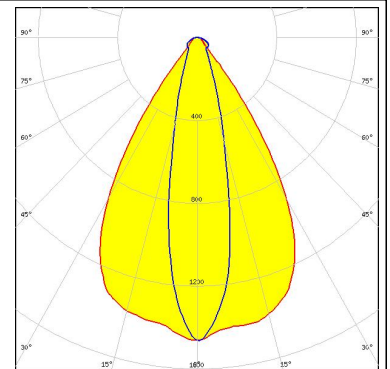
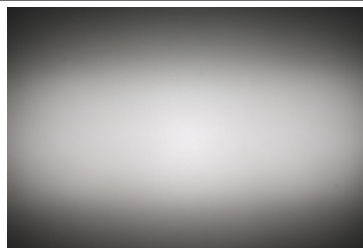

CREE

LED CXA/B 25xx
 FWHM 57.0 + 37.0°
 Efficiency 89 %
 Peak intensity 1.000 cd/lm
 Required components:

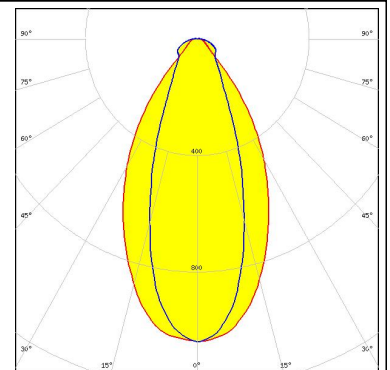
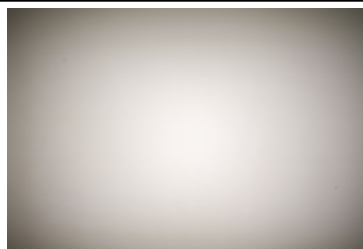

PHOTOMETRIC DATA (MEASURED):



LED LUXEON CoB 1202/1203
 FWHM 64.0 + 23.0°
 Efficiency 89 %
 Peak intensity 1.500 cd/lm
 Required components:

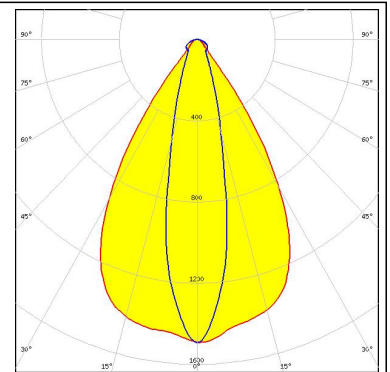
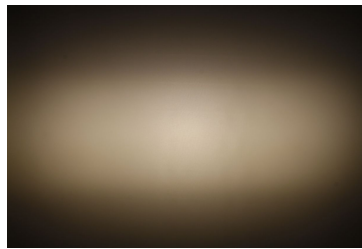

LED LUXEON CoB 1202s
 FWHM 65.0 + 19.0°
 Efficiency 90 %
 Peak intensity 1800.000 cd/lm
 Required components:

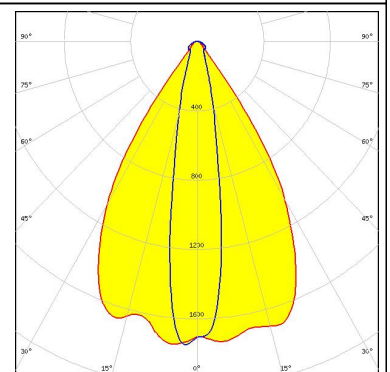
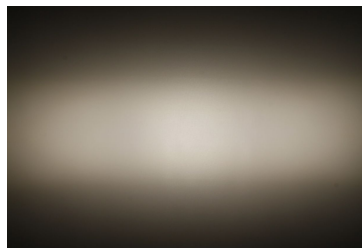

LED LUXEON CoB Compact
 FWHM 65.0 + 20.0°
 Efficiency 88 %
 Peak intensity 1.600 cd/lm
 Required components:

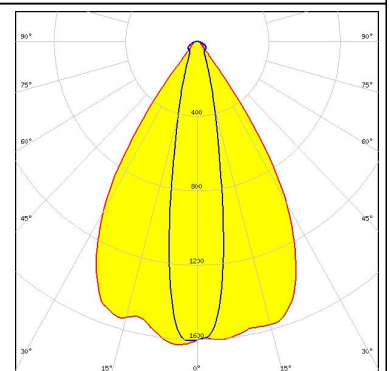
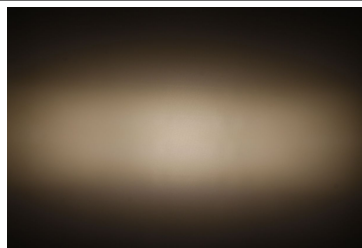

LED Soleriq P13
 FWHM 61.0 + 28.0°
 Efficiency 90 %
 Peak intensity 1.300 cd/lm
 Required components:

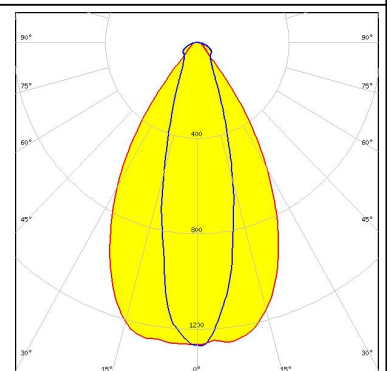
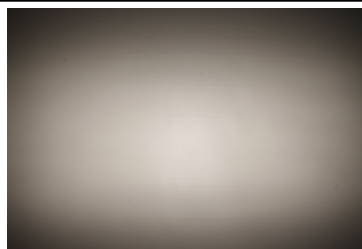

PHOTOMETRIC DATA (MEASURED):

OSRAM
Opto Semiconductors

LED Soleriq P6
FWHM 65.0 + 19.0°
Efficiency 89 %
Peak intensity 1.800 cd/lm
Required components:

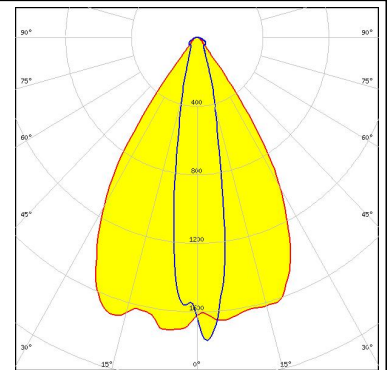
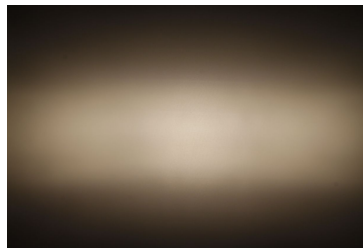

OSRAM
Opto Semiconductors

LED Soleriq P9
FWHM 64.0 + 22.0°
Efficiency 89 %
Peak intensity 1.600 cd/lm
Required components:

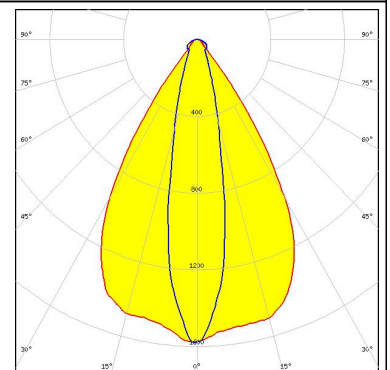
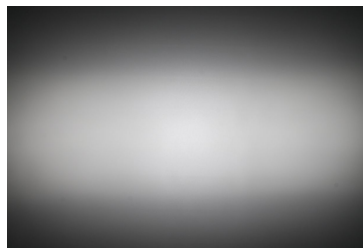

SAMSUNG

LED COB D Series LES 14.5 mm
FWHM 59.0 + 31.0°
Efficiency 85 %
Peak intensity 1.150 cd/lm
Required components:

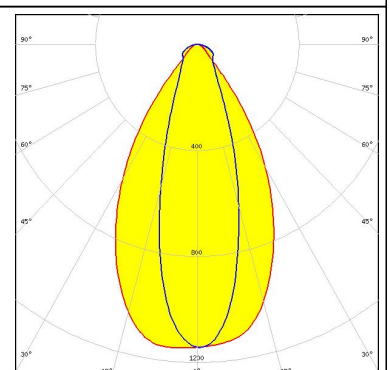
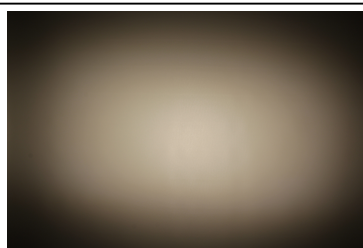



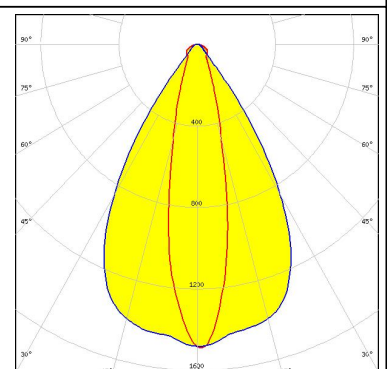
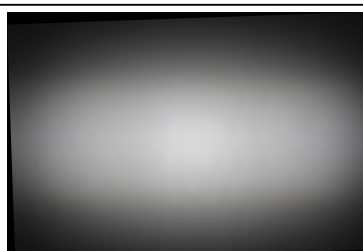

SAMSUNG

LED COB D Series LES 9.8 mm
FWHM 63.0 + 23.0°
Efficiency 87 %
Peak intensity 1.500 cd/lm
Required components:

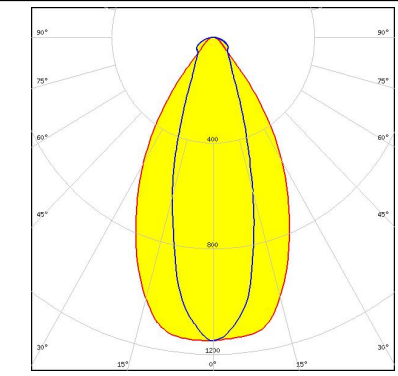

PHOTOMETRIC DATA (MEASURED):

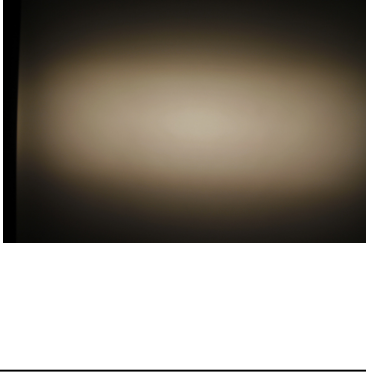
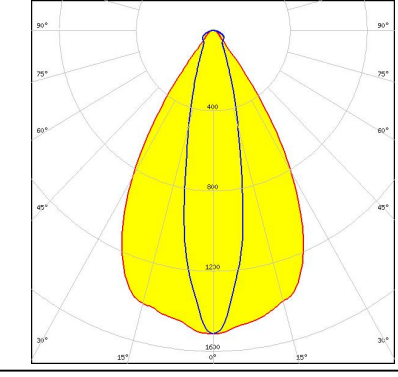
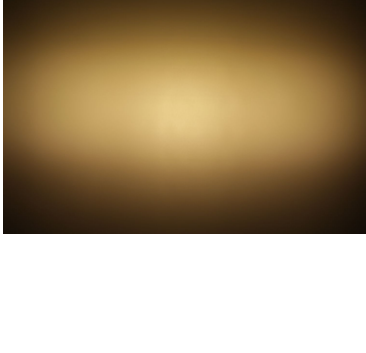
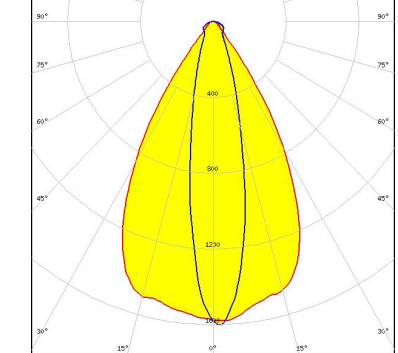
<p> SEOUL SEMICONDUCTOR</p> <p>LED MJT COB LES 14.5 FWHM 58.0 + 32.0° Efficiency 86 % Peak intensity 1.100 cd/lm Required components: Bender Wirth: 433 Typ L5</p>		
<p> SEOUL SEMICONDUCTOR</p> <p>LED MJT COB LES 9.8 FWHM 62.0 + 23.0° Efficiency 89 % Peak intensity 1.500 cd/lm Required components: Bender Wirth: 434 Typ L5</p>		
<p>TRIDONIC</p> <p>LED SLE G5 LES11 FWHM 61.0 + 21.0° Efficiency 89 % Peak intensity 1.600 cd/lm Required components:</p>		

PHOTOMETRIC DATA (SIMULATED):

OSRAM
Opto Semiconductors

LED Soleriq S9
 FWHM 61.0 + 24.0°
 Efficiency 88 %
 Peak intensity 1.600 cd/lm
 Required components:

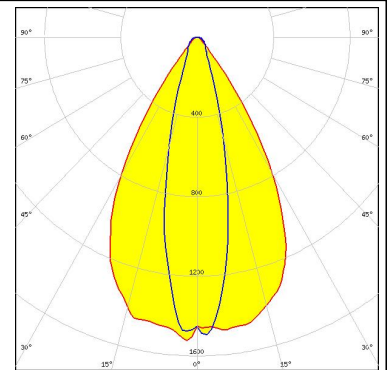

SAMSUNG

LED LC010C
 FWHM 56.0 + 16.0°
 Efficiency 92 %
 Peak intensity 2.200 cd/lm
 Required components:
 Bender Wirth: 479 Typ L5

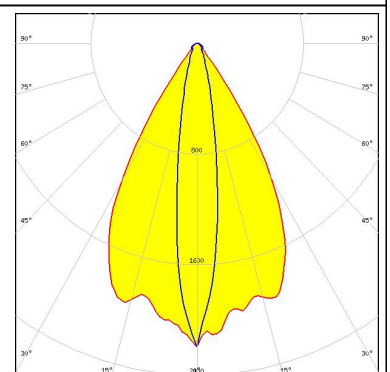

SAMSUNG

LED LC020C
 FWHM 60.0 + 18.0°
 Efficiency 89 %
 Peak intensity 1.900 cd/lm
 Required components:
 Bender Wirth: 479 Typ L5

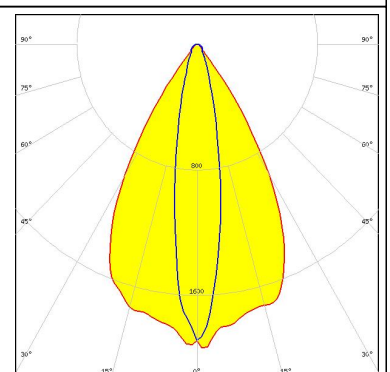

SAMSUNG

LED LC040C
 FWHM 60.0 + 24.0°
 Efficiency 87 %
 Peak intensity 1.500 cd/lm
 Required components:
 Bender Wirth: 479 Typ L5

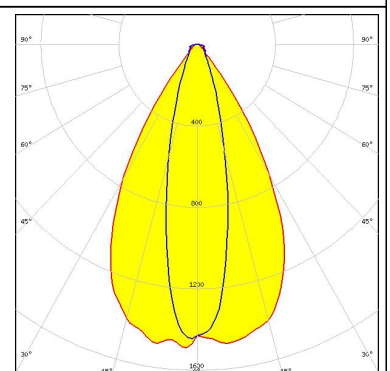

PHOTOMETRIC DATA (SIMULATED):

TRIDONIC

LED SLE G6 LES10
FWHM 20.0 + 60.0°
Efficiency 93 %
Peak intensity 1.910 cd/lm
Required components:
Bender Wirth: 434 Typ L5

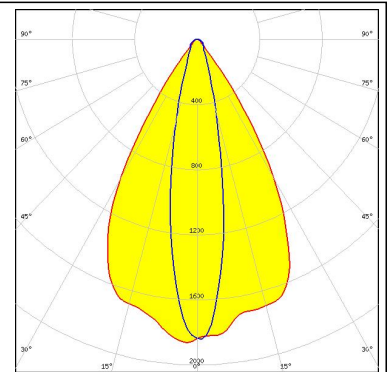

TRIDONIC

LED SLE G6 LES15
FWHM 59.0 + 28.0°
Efficiency 89 %
Peak intensity 1.400 cd/lm
Required components:
Bender Wirth: 433 Typ L5

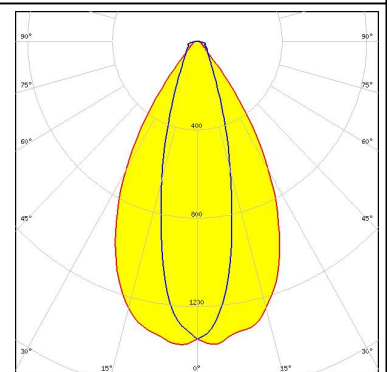

TRIDONIC

LED SLE G6 LES17
FWHM 55.0 + 27.0°
Efficiency 92 %
Peak intensity 1.420 cd/lm
Required components:
Bender Wirth: 433 Typ L5

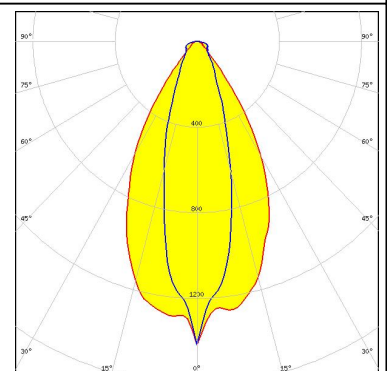

GENERAL INFORMATION:

NOTE: The typical beam angle will be changed by different color, chip size and chip position tolerance. The typical total beam angle is the full angle measured where the luminous intensity is half of the peak value.

Due to use of high power COB's with this product, special attention to proper thermal design is highly recommended. LEDiL has no liability for direct, indirect or consecutive damages arising from the LEDiL products being used outside of the recommended temperature range.

MATERIALS:

As part of our continuous research and improvement processes, and to ensure the best possible quality and availability of our products, LEDiL reserves the right to change material grades without notice.

PRODUCT DATA USER AGREEMENT AND DISCLAIMER:

The measured data in the provided downloadable LEDiL Product Datasheets and Mechanical 2D-Drawings is rounded and provided as reference for planning. LEDiL Oy's optical specifications have been verified by conducting performance testing of the products in accordance with the company's quality system. The reported data are averaged results of multiple measurements with typical variation. LEDiL Oy reserves the right to without prior notification make changes and improvements to its products.

LEDiL Oy assumes neither warranty, nor guarantee nor any other liability of any kind for the contents and correctness of the provided data. The provided data has been generated with highest diligence but the provided data may in reality not represent the complete possible variation range of all intrinsic parameters. Therefore, in certain cases a deviation from the provided data could occur.

LEDiL Oy reserves the right to undertake technical changes of its products without further notification which could lead to changes in the provided data. LEDiL Oy assumes no liability of any kind for the possible deviation from any provided data or any other damage resulting from the usage of the provided data.

The user agrees to this disclaimer and user agreement with the download or usage of the provided files.

LEDiL Oy

Joensuunkatu 13
FI-24240 SALO
Finland

LEDiL Inc.

228 West Page Street
Suite D
Sycamore IL 60178
USA

Local sales and technical support

[www.ledil.com/
where_to_buy](http://www.ledil.com/where_to_buy)

Shipping locations

Salo, Finland
Hong Kong, China

Distribution Partners

[www.ledil.com/
where_to_buy](http://www.ledil.com/where_to_buy)