

V_{DSS}	-20V
$R_{DS(on)}(Max.)$	430mΩ
I_D	±1.5A
P_D	1.25W

●Features

- 1) The QS6U22 combines Pch MOSFET with a Schottky barrier diode in a single TSMT6 package.
- 2) High-speed switching, Low On-resistance.
- 3) Low voltage drive (2.5V drive).
- 4) Built-in Low V_F schottky barrier diode.
- 5) Pb-free lead plating ; RoHS compliant.

●Application

switching

●Absolute maximum ratings ($T_a = 25^\circ C$)

<MOSFET>

Parameter	Symbol	Value	Unit
Drain - Source voltage	V_{DSS}	-20	V
Gate - Source voltage	V_{GSS}	±12	V
Continuous drain current	I_D	±1.5	A
Pulsed drain current	$I_{D,pulse}^{*1}$	±6.0	A
Continuous source current (body diode)	I_S	-0.75	A
Pulsed source current (body diode)	$I_{S,pulse}^{*1}$	-6.0	A
Power dissipation	P_D^{*3}	0.9	W/element
Junction temperature	T_j	150	°C

●Outline

TSMT6

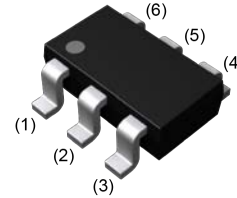

●Inner circuit

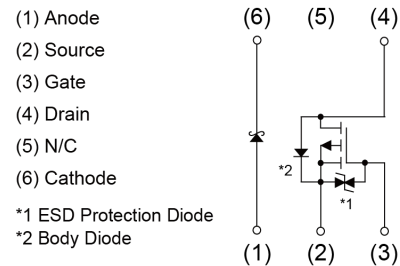

●Packaging specifications

Type	Packing	Embossed Tape
	Reel size (mm)	180
	Tape width (mm)	8
	Basic ordering unit (pcs)	3000
	Taping code	TR
	Marking	U22

● **Absolute maximum ratings** ($T_a = 25^\circ\text{C}$)

<SBD>

Parameter	Symbol	Value	Unit
Repetitive peak reverse voltage	V_{RM}	25	V
Reverse voltage	V_R	20	V
Forward current	I_F	0.7	A
Forward current surge peak	I_{FSM}^{*2}	3.0	A
Power dissipation	P_D^{*3}	0.7	W/element
Junction temperature	T_j	150	$^\circ\text{C}$

<MOSFET + SBD>

Parameter	Symbol	Value	Unit
Power dissipation	P_D^{*3}	1.25	W/total
Range of storage temperature	T_{stg}	-55 to +150	$^\circ\text{C}$

● **Electrical characteristics** ($T_a = 25^\circ\text{C}$)

<MOSFET>

Parameter	Symbol	Conditions	Values			Unit
			Min.	Typ.	Max.	
Gate - Source leakage current	I_{GSS}	$V_{GS} = \pm 12\text{V}, V_{DS} = 0\text{V}$	-	-	± 10	μA
Drain - Source breakdown voltage	$V_{(BR)DSS}$	$V_{GS} = 0\text{V}, I_D = -1\text{mA}$	-20	-	-	V
Zero gate voltage drain current	I_{DSS}	$V_{DS} = -20\text{V}, V_{GS} = 0\text{V}$	-	-	-1	μA
Gate threshold voltage	$V_{GS(th)}$	$V_{DS} = -10\text{V}, I_D = -1\text{mA}$	-0.7	-	-2.0	V
Static drain - source on - state resistance	$R_{DS(on)}^{*4}$	$V_{GS} = -4.5\text{V}, I_D = -1.5\text{A}$	-	155	215	m Ω
		$V_{GS} = -4\text{V}, I_D = -1.5\text{A}$	-	170	235	
		$V_{GS} = -2.5\text{V}, I_D = -0.75\text{A}$	-	310	430	
Transconductance	g_{fs}^{*4}	$V_{DS} = -10\text{V}, I_D = -0.75\text{A}$	1.0	-	-	S

● **Electrical characteristics** ($T_a = 25^\circ\text{C}$)

<MOSFET>

Parameter	Symbol	Conditions	Values			Unit
			Min.	Typ.	Max.	
Input capacitance	C_{iss}	$V_{GS} = 0V$	-	270	-	pF
Output capacitance	C_{oss}	$V_{DS} = -10V$	-	40	-	
Reverse transfer capacitance	C_{rss}	$f = 1\text{MHz}$	-	35	-	
Turn - on delay time	$t_{d(on)}^{*4}$	$V_{DD} \approx -15V, V_{GS} = -4.5V$	-	10	-	ns
Rise time	t_r^{*4}	$I_D = -0.75A$	-	12	-	
Turn - off delay time	$t_{d(off)}^{*4}$	$R_L = 20\Omega$	-	45	-	
Fall time	t_f^{*4}	$R_G = 10\Omega$	-	20	-	

● **Gate charge characteristics** ($T_a = 25^\circ\text{C}$)

<MOSFET>

Parameter	Symbol	Conditions	Values			Unit
			Min.	Typ.	Max.	
Total gate charge	Q_g^{*4}	$V_{DD} \approx -15V, I_D = -1.5A$ $V_{GS} = -4.5V$	-	3.0	-	nC
Gate - Source charge	Q_{gs}^{*4}		-	0.8	-	
Gate - Drain charge	Q_{gd}^{*4}		-	0.85	-	

● **Body diode electrical characteristics** (Source-Drain) ($T_a = 25^\circ\text{C}$)

<MOSFET>

Parameter	Symbol	Conditions	Values			Unit
			Min.	Typ.	Max.	
Forward voltage	V_{SD}^{*4}	$V_{GS} = 0V, I_S = -0.75A$	-	-	-1.2	V

● **Electrical characteristics** ($T_a = 25^\circ\text{C}$)

<SBD>

Parameter	Symbol	Conditions	Values			Unit
			Min.	Typ.	Max.	
Forward voltage	V_F	$I_F = 0.7\text{A}$	-	-	0.49	V
Reverse current	I_R	$V_R = 20\text{V}$	-	-	200	μA

*1 $P_w \leq 10\mu\text{s}$, Duty cycle $\leq 1\%$

*2 60Hz · 1 cycle

*3 Mounted on a ceramic board

*4 Pulsed

● Electrical characteristic curves <MOSFET>

Fig.1 Typical Capacitance vs. Drain - Source Voltage

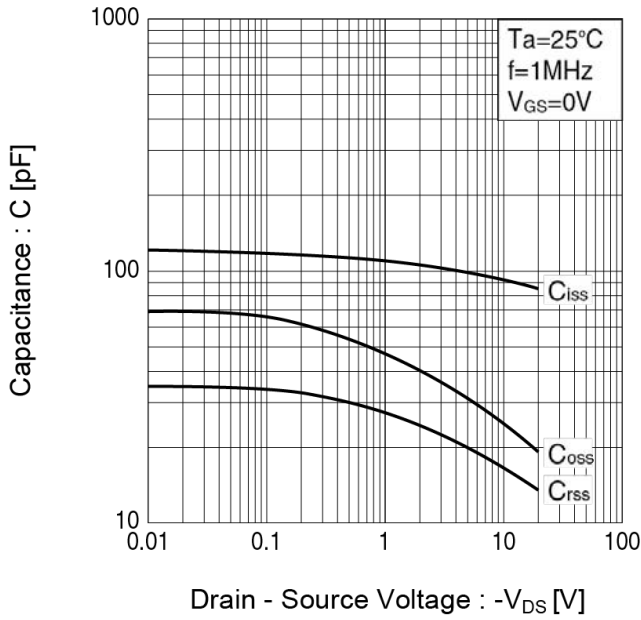

Fig.2 Switching Characteristics

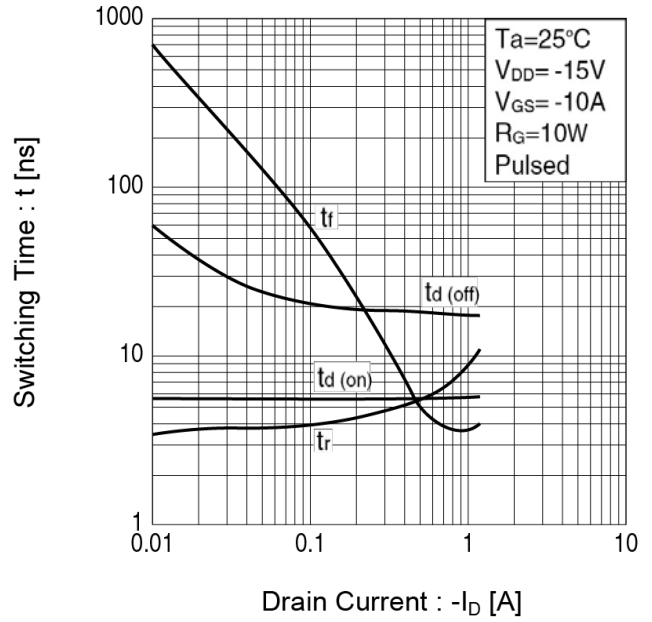
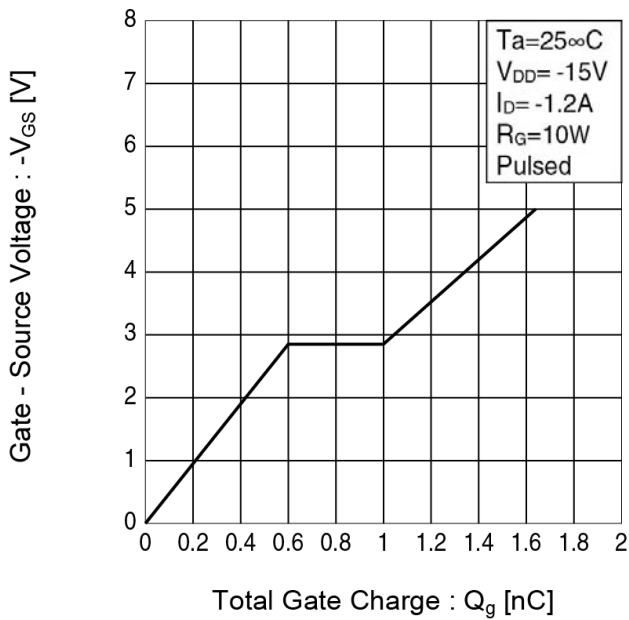

Fig.3 Dynamic Input Characteristics



● Electrical characteristic curves <MOSFET>

Fig.4 Typical Transfer Characteristics

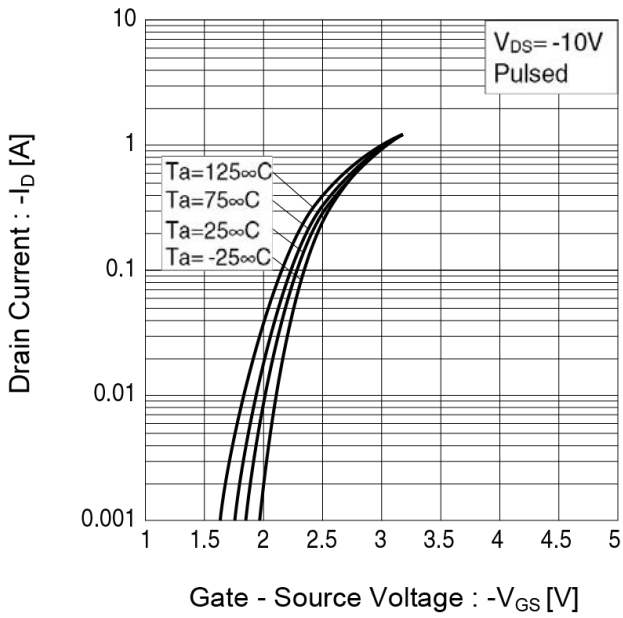

Fig.5 Static Drain - Source On - State Resistance vs. Gate Source Voltage

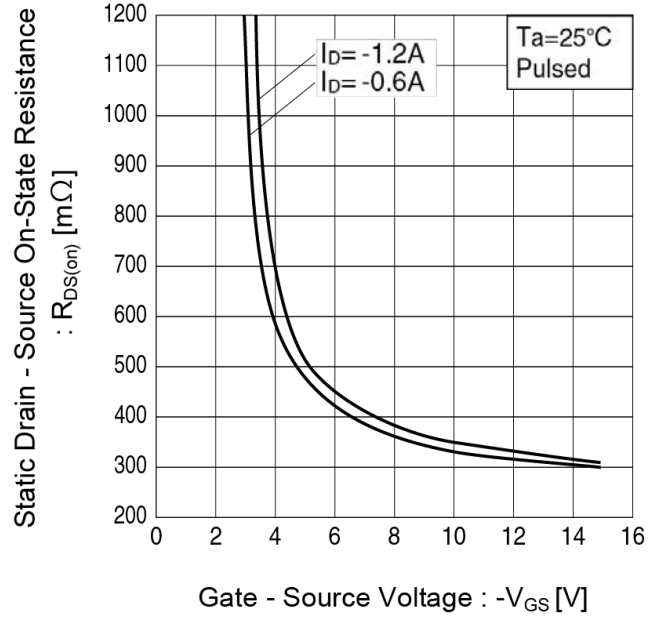
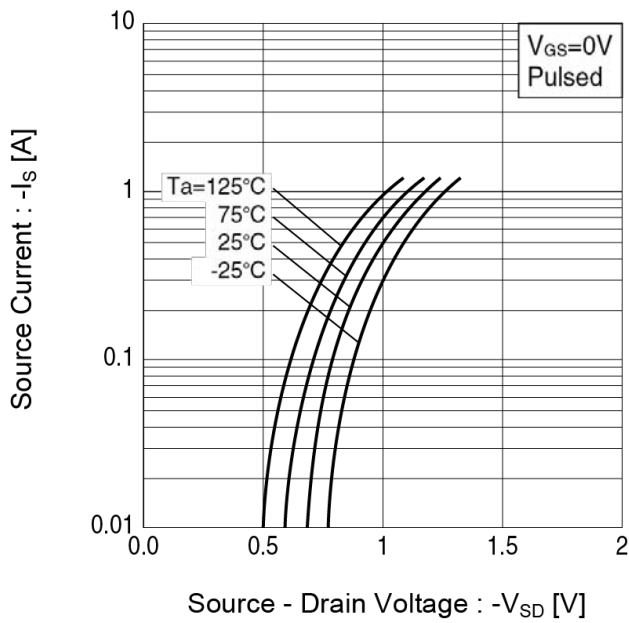

Fig.6 Source Current vs. Source Drain Voltage



● Electrical characteristic curves <MOSFET>

Fig.7 Static Drain - Source On - State Resistance vs. Drain Current (I)

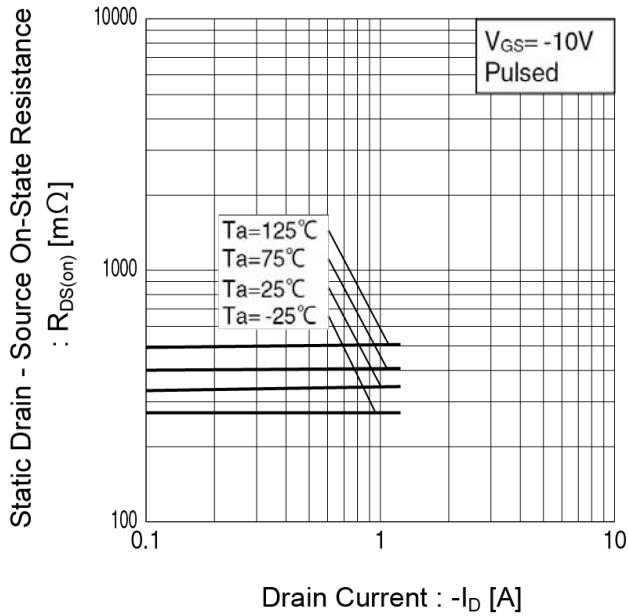

Fig.8 Static Drain - Source On - State Resistance vs. Drain Current (II)

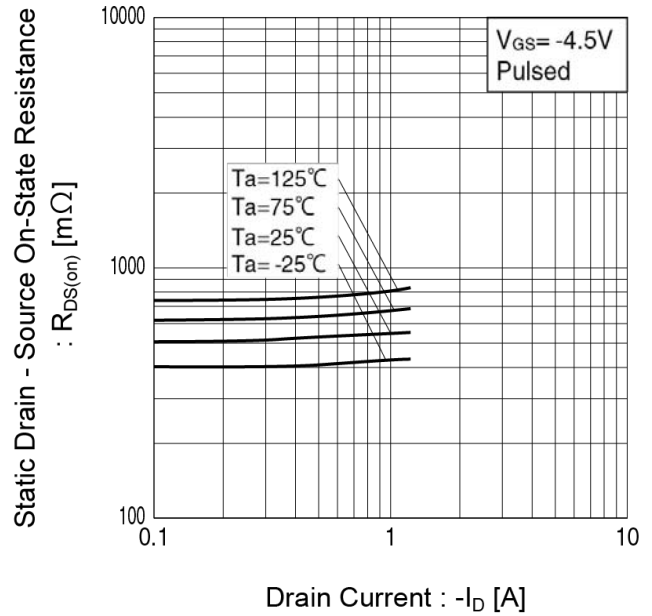

Fig.9 Static Drain - Source On - State Resistance vs. Drain Current (III)

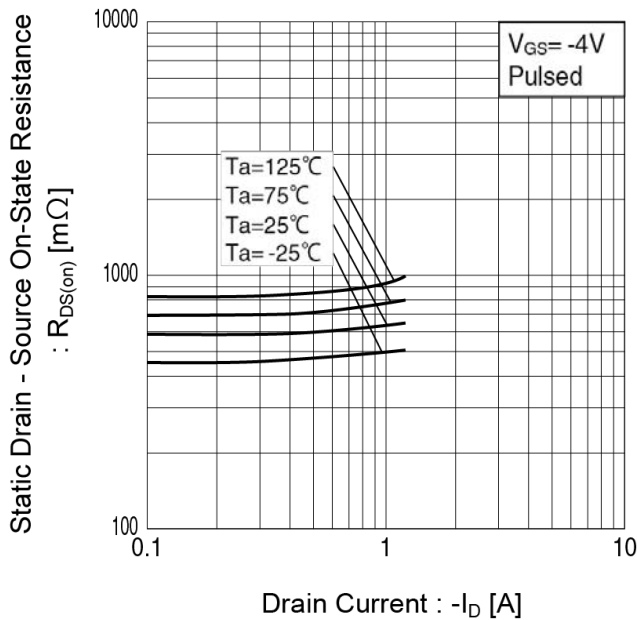
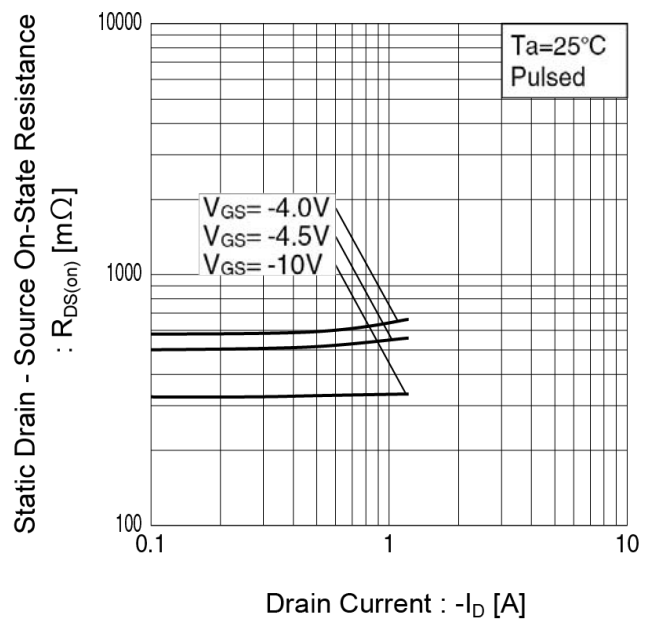

Fig.10 Static Drain - Source On - State Resistance vs. Drain Current (IV)



● Electrical characteristic curves <SBD>

Fig.11 Forward Current vs. Forward Voltage

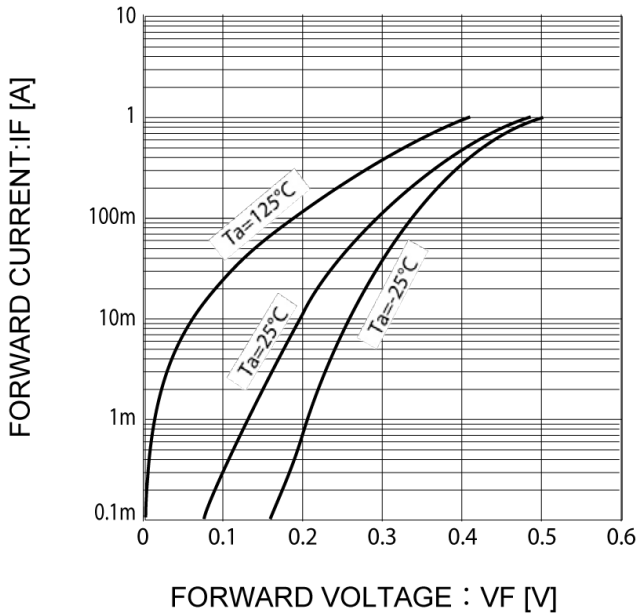
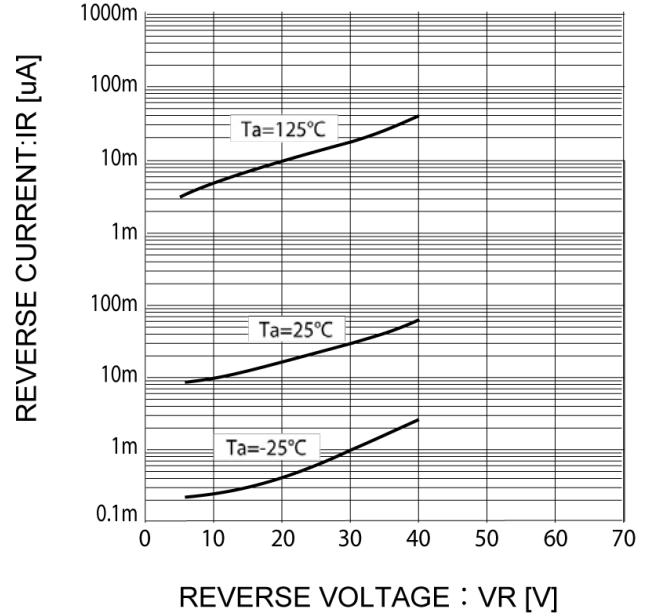

Fig.12 Reverse Current vs. Reverse Voltage



● Notice

1. SBD has a large reverse leak current compared to other type of diode. Therefore, it would raise a junction temperature, and increase a reverse power loss. Further rise of inside temperature would cause a thermal runaway. This built-in SBD has low V_F characteristics and therefore, higher leak current. Please consider enough the surrounding temperature, generating heat of MOSFET and the reverse current.
2. This product might cause chip aging and breakdown under the large electrified environment. Please consider to design ESD protection circuit.

● Measurement circuits

Fig.1-1 Switching Time Measurement Circuit

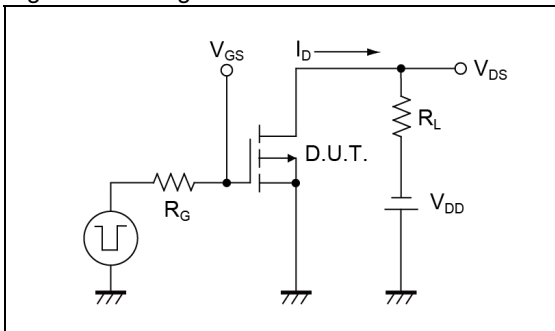

Fig.1-2 Switching Waveforms

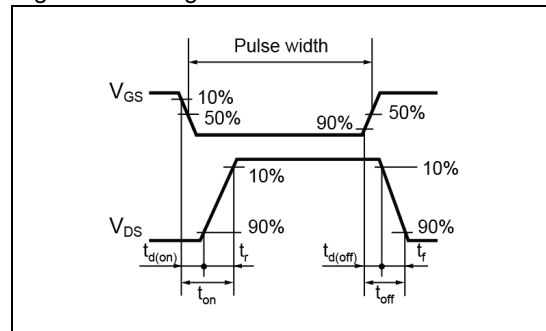

Fig.2-1 Gate Charge Measurement Circuit

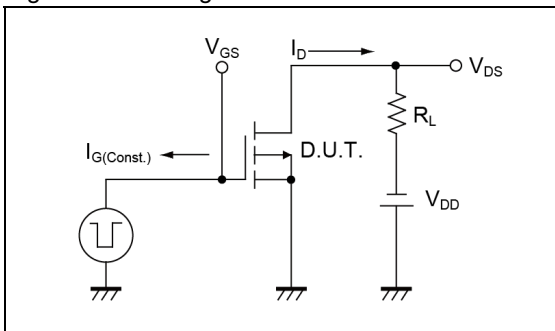
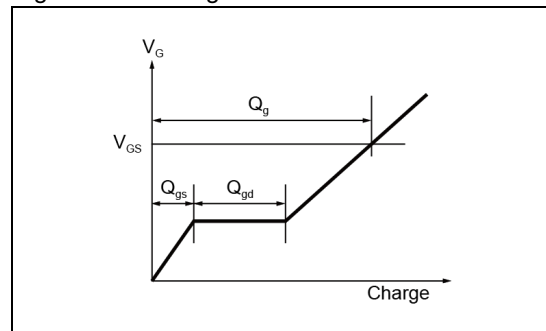
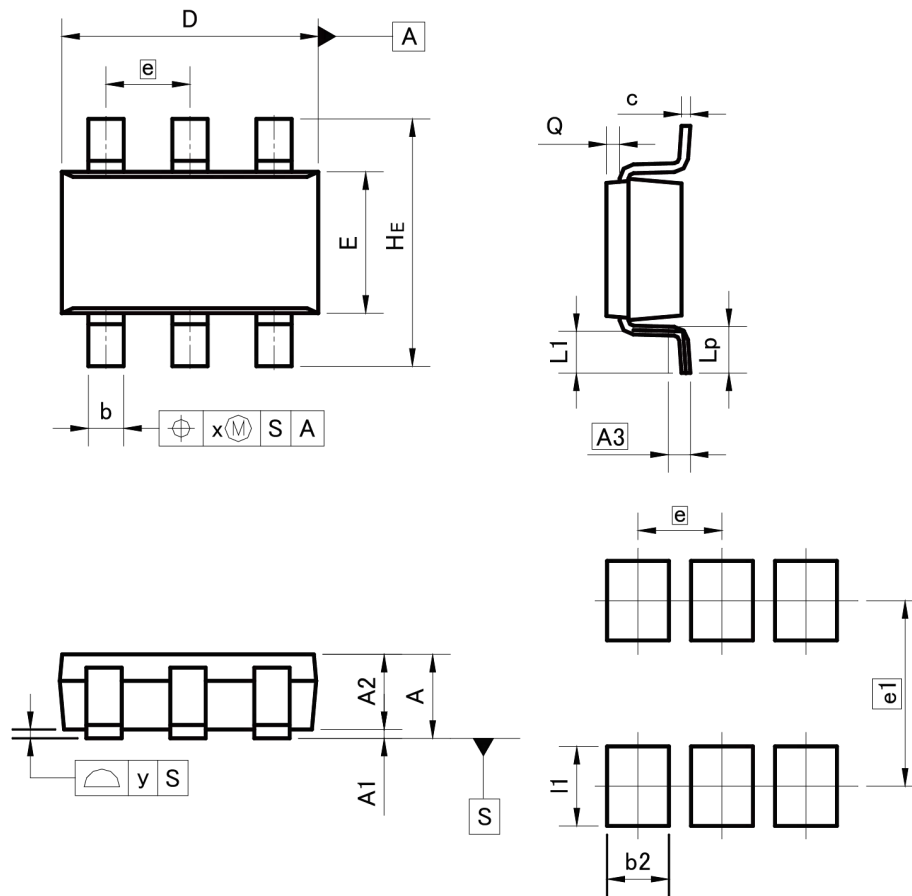

Fig.2-2 Gate Charge Waveform



●Dimensions

TSMT6



Pattern of terminal position areas
[Not a recommended pattern of soldering pads]

DIM	MILIMETERS		INCHES	
	MIN	MAX	MIN	MAX
A	-	1.00	-	0.039
A1	0.00	0.10	0.000	0.004
A2	0.75	0.95	0.030	0.037
A3	0.25		0.010	
b	0.35	0.50	0.014	0.020
c	0.10	0.26	0.004	0.010
D	2.80	3.00	0.110	0.118
E	1.50	1.80	0.059	0.071
e	0.95		0.037	
HE	2.60	3.00	0.102	0.118
L1	0.30	0.60	0.012	0.024
Lp	0.40	0.70	0.016	0.028
Q	0.05	0.25	0.002	0.010
x	-	0.20	-	0.008
y	-	0.10	-	0.004

DIM	MILIMETERS		INCHES	
	MIN	MAX	MIN	MAX
b2	-	0.70	-	0.028
e1	2.10		0.083	
I1	-	0.90	-	0.035

Dimension in mm/inches

Notes

- 1) The information contained herein is subject to change without notice.
- 2) Before you use our Products, please contact our sales representative and verify the latest specifications :
- 3) Although ROHM is continuously working to improve product reliability and quality, semiconductors can break down and malfunction due to various factors. Therefore, in order to prevent personal injury or fire arising from failure, please take safety measures such as complying with the derating characteristics, implementing redundant and fire prevention designs, and utilizing backups and fail-safe procedures. ROHM shall have no responsibility for any damages arising out of the use of our Products beyond the rating specified by ROHM.
- 4) Examples of application circuits, circuit constants and any other information contained herein are provided only to illustrate the standard usage and operations of the Products. The peripheral conditions must be taken into account when designing circuits for mass production.
- 5) The technical information specified herein is intended only to show the typical functions of and examples of application circuits for the Products. ROHM does not grant you, explicitly or implicitly, any license to use or exercise intellectual property or other rights held by ROHM or any other parties. ROHM shall have no responsibility whatsoever for any dispute arising out of the use of such technical information.
- 6) The Products are intended for use in general electronic equipment (i.e. AV/OA devices, communication, consumer systems, gaming/entertainment sets) as well as the applications indicated in this document.
- 7) The Products specified in this document are not designed to be radiation tolerant.
- 8) For use of our Products in applications requiring a high degree of reliability (as exemplified below), please contact and consult with a ROHM representative : transportation equipment (i.e. cars, ships, trains), primary communication equipment, traffic lights, fire/crime prevention, safety equipment, medical systems, servers, solar cells, and power transmission systems.
- 9) Do not use our Products in applications requiring extremely high reliability, such as aerospace equipment, nuclear power control systems, and submarine repeaters.
- 10) ROHM shall have no responsibility for any damages or injury arising from non-compliance with the recommended usage conditions and specifications contained herein.
- 11) ROHM has used reasonable care to ensure the accuracy of the information contained in this document. However, ROHM does not warrants that such information is error-free, and ROHM shall have no responsibility for any damages arising from any inaccuracy or misprint of such information.
- 12) Please use the Products in accordance with any applicable environmental laws and regulations, such as the RoHS Directive. For more details, including RoHS compatibility, please contact a ROHM sales office. ROHM shall have no responsibility for any damages or losses resulting non-compliance with any applicable laws or regulations.
- 13) When providing our Products and technologies contained in this document to other countries, you must abide by the procedures and provisions stipulated in all applicable export laws and regulations, including without limitation the US Export Administration Regulations and the Foreign Exchange and Foreign Trade Act.
- 14) This document, in part or in whole, may not be reprinted or reproduced without prior consent of ROHM.



Thank you for your accessing to ROHM product informations.
More detail product informations and catalogs are available, please contact us.

ROHM Customer Support System

<http://www.rohm.com/contact/>