



PSE Technology Corporation

SPECIFICATION FOR APPROVAL

CUSTOMER	_____
NOMINAL FREQUENCY	156.250000 MHz
PRODUCT TYPE	TYPE UX 5.0x3.2 SEAM SEALED CRYSTAL CLOCK OSCILLATOR
SPEC. NO. (P/N)	UX54F62001
CUSTOMER P/N	_____
ISSUE DATE	August 12, 2015
VERSION	A

APPROVED	PREPARED	QA
		
APPROVED BY CUSTOMER :		AVL Status
Please return one copy with approval to PSE-TW		

PSE Technology Corporation

No.2, Tzu-Chiang 5th Rd, Chung Li Industrial Park,
 Chung Li City, Taoyuan County, Taiwan (R.O.C.)
 TEL: 886-3-451-8888
 FAX: 886-3-461-3865
<http://www.saronix-ecera.com.tw>

- *Pb-free
- *RoHS Compliant
- *HF-Halogen Free
- *REACH Compliant

*** A company of  **PERICOM Semiconductor Corporation** ***

TYPE UX 5.0x3.2 SEAM SEALED CRYSTAL CLOCK OSCILLATOR

UX54F62001

VER. A 12-Aug-15

ELECTRICAL SPECIFICATIONS

SRe Part Number : UX54F62001

Item	Symbol	Specifications	Units	Notes
Nominal Frequency	Fo	156.250000	MHz	
Frequency Stability	FT	± 50	ppm	**See note
Operating Temperature Range	TR	-40 to +85	°C	
Supply Voltage	V _{CC}	+3.3 ± 10.0%	V	
Logic Type	LT	HCSL		
Supply Current, Output Enabled	I _{CC} /OE	60	mA	Max.
Supply Current, Output Disabled	I _{CC} /OD	10	uA	Max.
Duty Cycle (Symmetry)	DC/SY	45 / 55	%	Measured 50% of Waveform
Rise / Fall Time	T _R /T _F	0.85	ns	Max. measured from Vol=0.175V to Voh=0.525V
Output Voltage "0" Level	V _{OL}	-0.150	V	Min. 0.0V Typ.
Output Voltage "1" Level	V _{OH}	0.850	V	Max. 0.660V Min. 0.700V Typ.
Output Load		Rs=33Ω, Rp=50Ω, CL=2pF		Typ. In HCSL termination
Output Phase Jitter-PCIe Gen2		2.5	ps RMS	Max.
Jitter, Phase	RMS	0.11 / 0.16	ps	Typ. / Max. 12KHz ~ 20MHz Frequency Band
Jitter, Accumulated	RMS(1-σ)	4	ps	Max. 20,000 Consecutive Periods
Jitter, Peak to Peak	Pk-Pk	20 / 30	ps	Typ. / Max. 100,000 Random Periods
Phase Noise		-139	dBc/Hz	Typ. at 10kHz offset
Phase Noise		-140	dBc/Hz	Typ. at 100kHz offset
Phase Noise		-153	dBc/Hz	Typ. at 1MHz offset
Phase Noise		-160	dBc/Hz	Typ. at 10MHz offset
Phase Noise		-160	dBc/Hz	Typ. at 20MHz offset
Phase Noise		-160	dBc/Hz	Typ. at 100MHz offset
Edge Rate	Edge_rate	1.0 / 4.0	V/ns	Min. / Max., measured from -150mV to +150mV on the differential waveform
Absolute Crossing Point Voltages	V _{cross absolute}	250 / 550	mV	Min. / Max., measured at crossing point of output and output N on the single ended waveform
Start Up Time		10	ms	Max.
Storage Temperature Range		-55 to +125	°C	

※ This product doesn't include harmful substance that stipulated by SONY SS-00259 Level 1 and S-AT2-001 Level 1 standard. RoHS Compliant (Pb - Free).

**Stability includes all combinations of Operating Temperature, Load changes, rated Input (Supply) Voltage changes, Initial Calibration Tolerance (25°C), Aging (1 year at 25°C Average Effective Ambient Temperature), Shock and Vibration.

Output Enable / Disable Function

Parameter	Min.	Typ.	Max.	Units	Notes
Input Voltage (Pin1), Output Enable	0.7V _{CC}			V	Or Open
Input Voltage (Pin1), Output Disable (low power standby)			0.3V _{CC}	V	Output is Hi-Z
Output Disable Delay			200	ns	
Output Enable Delay			2	ms	

TYPE UX 5.0x3.2 SEAM SEALED CRYSTAL CLOCK OSCILLATOR

UX54F62001

VER. A 12-Aug-15

TEST CIRCUIT

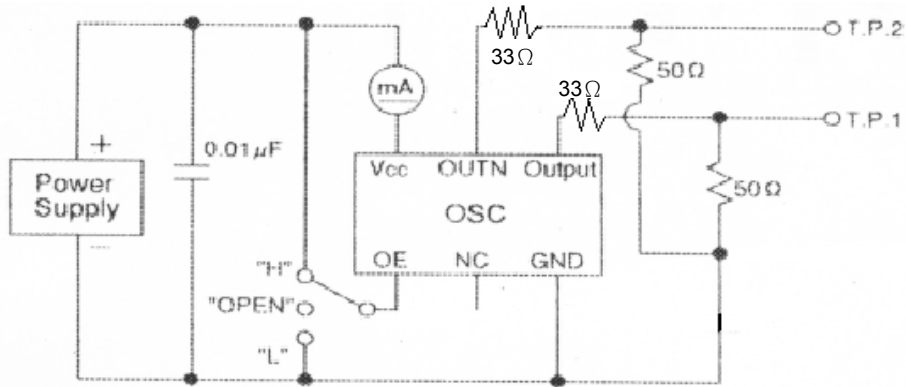

OUTPUT WAVEFORM

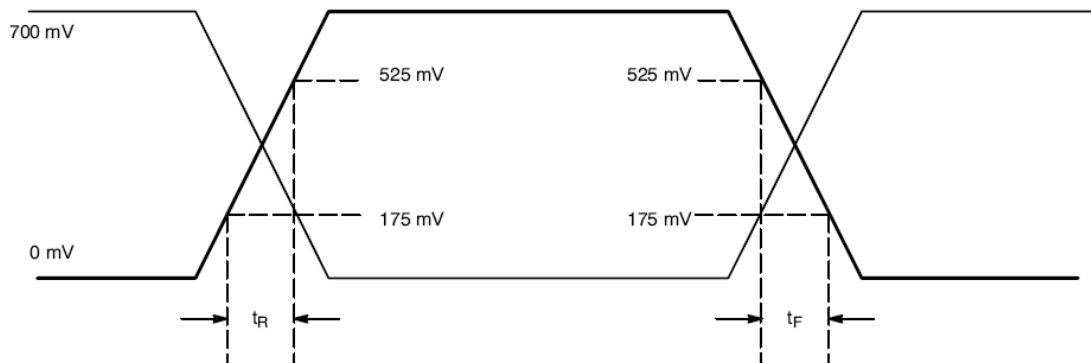

TYPE UX 5.0x3.2 SEAM SEALED CRYSTAL CLOCK OSCILLATOR

UX54F62001

VER. A 12-Aug-15

RELIABILITY SPECIFICATIONS

ENVIRONMENTAL:

- a) THERMAL SHOCK: MIL-STD-883, Method 1011, Condition A
- b) MOISTURE RESISTANCE: MIL-STD-883, Method 1004
- c) VIBRATION: MIL-STD-883, Method 2007, Condition A
- d) RESISTANCE TO SOLDERING HEAT: J-STD-020D Table 5-2 Pb-free devices (except 2 cycles max)
- e) HAZARDOUS SUBSTANCE: Pb - free and RoHS/Green Compliant.

MECHANICAL:

- a) SHOCK: MIL-STD-883, Method 2002, Condition B
- b) SOLDERABILITY: JESD22-B102-D Method 2 (Preconditioning E)
- c) TERMINAL STRENGTH: MIL-STD-883, Method 2004, Test Condition D
- d) GROSS LEAK: MIL-STD-883, Method 1014, Condition C
- e) FINE LEAK: MIL-STD-883, Method 1014, Condition A2, $R1=2 \times 10^{-8}$ atm cc/s
- f) SOLVENT RESISTANCE: MIL-STD-202, Method 215

SUGGESTED IR REFLOW PROFILE

*As per IPC-JEDEC J-STD-020D

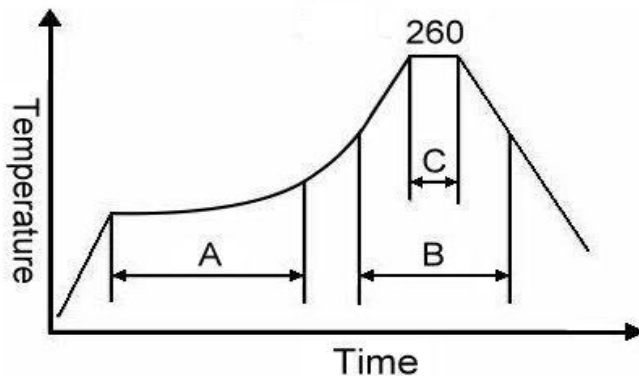

Note:

	Stage	Temperature	Time
A	Preheat	150~200°C	60~120 Sec
B	Primary Heat	217°C	60~150 Sec
C	Peak	260°C	10 Sec

For soldering reflow profile and reliability test ratings go to: <http://www.pericom.com/pdf/sre/reflow.pdf>

TYPE UX 5.0x3.2 SEAM SEALED CRYSTAL CLOCK OSCILLATOR

UX54F62001

VER. A 12-Aug-15

MARKING

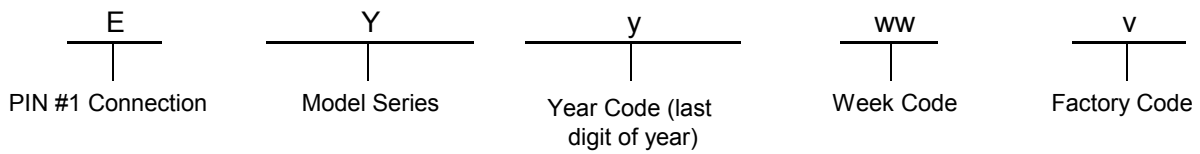
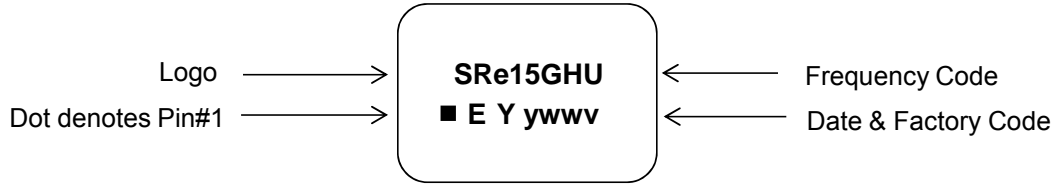

MECHANICAL DRAWINGS (Scale:None. Dimensions are in mm.)

Recommended Land Pattern*

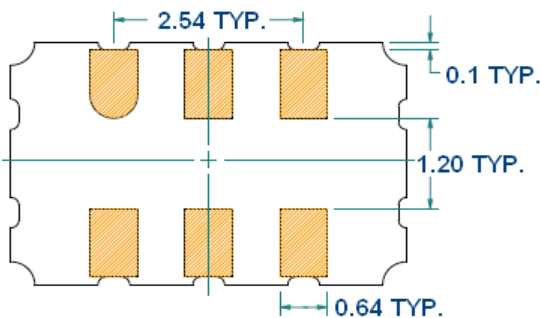
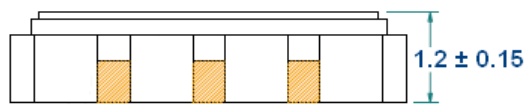
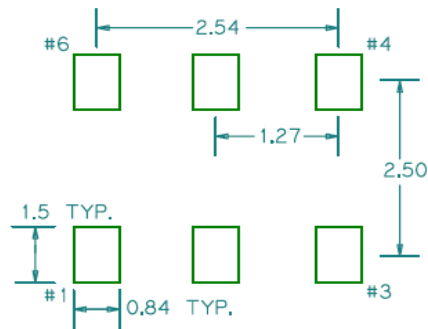
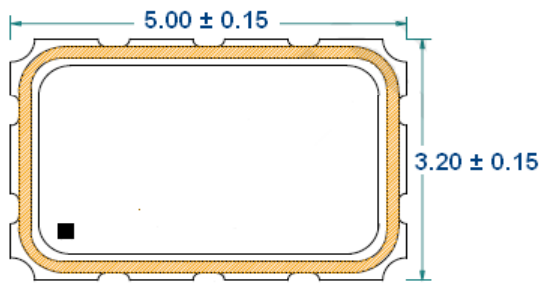

Pin	Function
1	OE
2	NC
3	V _{EE}
4	OUTPUT
5	OUTPUT N
6	V _{CC}

TYPE UX 5.0x3.2 SEAM SEALED CRYSTAL CLOCK OSCILLATOR

UX54F62001

VER. A 12-Aug-15

TAPE&REEL

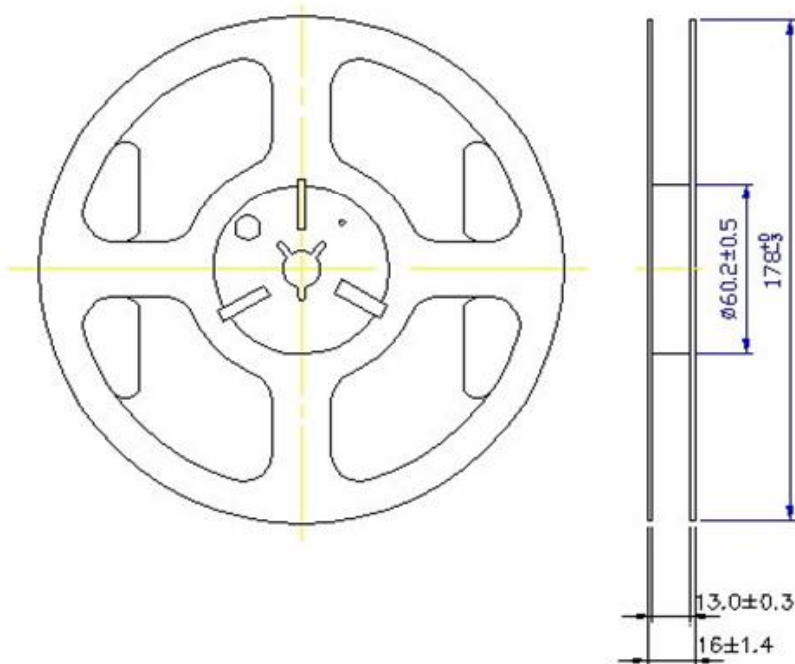
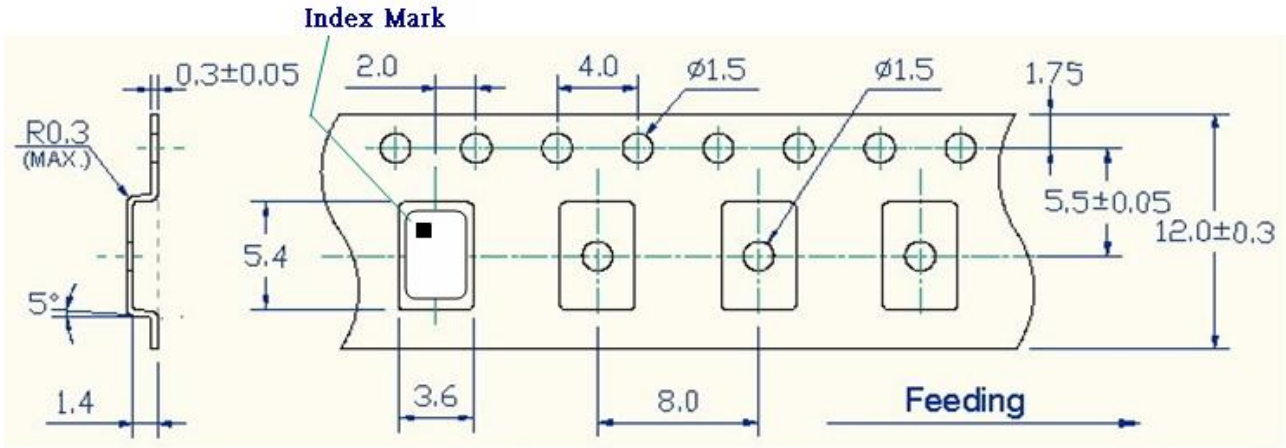

1. 230mm minimum leader which consist of carrier and/or tape followed by a minimum of 160mm of empty carrier tape sealed with cover tape.
2. 160mm minimum trailer of empty carrier tape sealed with cover tape.

TYPE UX 5.0x3.2 SEAM SEALED CRYSTAL CLOCK OSCILLATOR

UX54F62001

VER. A 12-Aug-15

PACKING

