

C3216X8R1H334K160AA

TDK Item Description : C3216X8R1H334KT****



Application & Main Feature

Commercial Grade (High Temperature Application)

Series

C3216 [EIA CC1206]

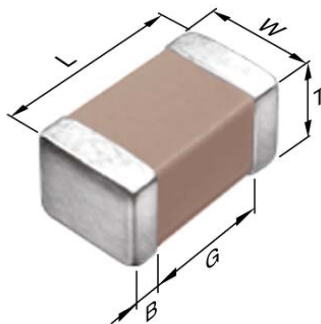

Dimensions

L 3.20mm +/-0.2mm
 W 1.60mm +/-0.2mm
 T 1.60mm +/-0.2mm
 B 0.20mm Min.
 G 1.00mm Min.

Temperature Characteristic

X8R (-55 to 150 degC +/-15%)

Rated Voltage

1H (50Vdc)

Capacitance

330nF

Capacitance Tolerance

K (+/-10%)

Dissipation Factor

3% Max.

Insulation Resistance

1.52Gohm Min.

AEC-Q200

Not Applicable

DC Bias Characteristic

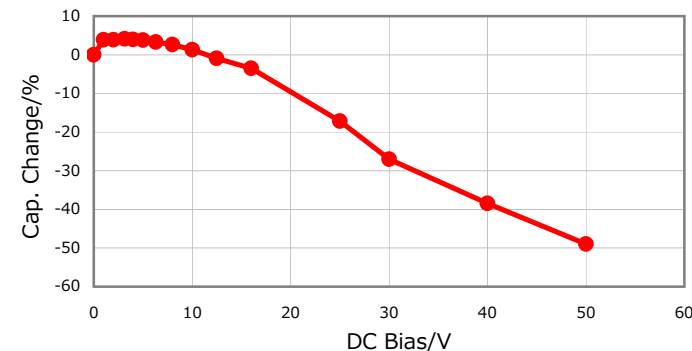

|Z|, ESR vs. Freq. Characteristics

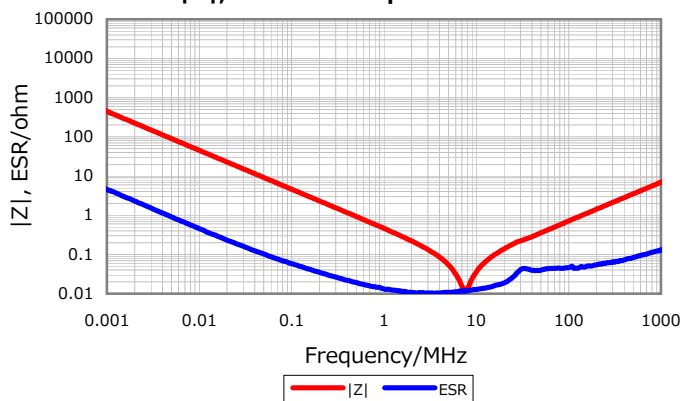

Temperature Characteristics

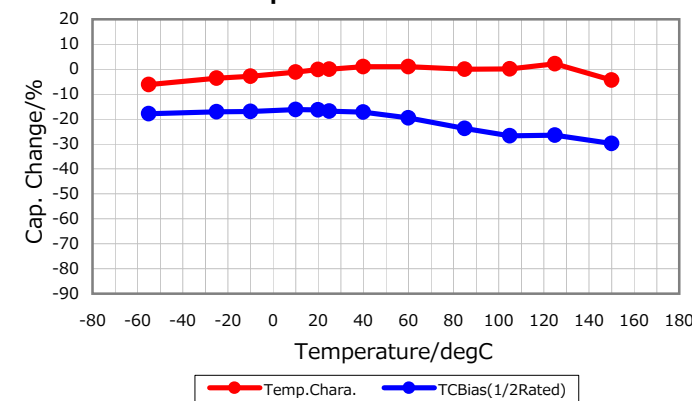

Cap. vs. Freq. Characteristic

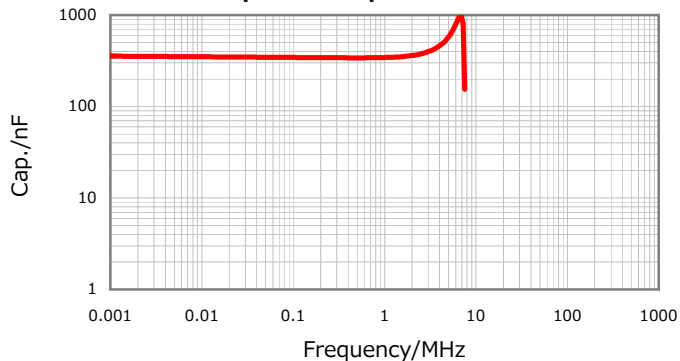

Ripple Temperature Rise Characteristics

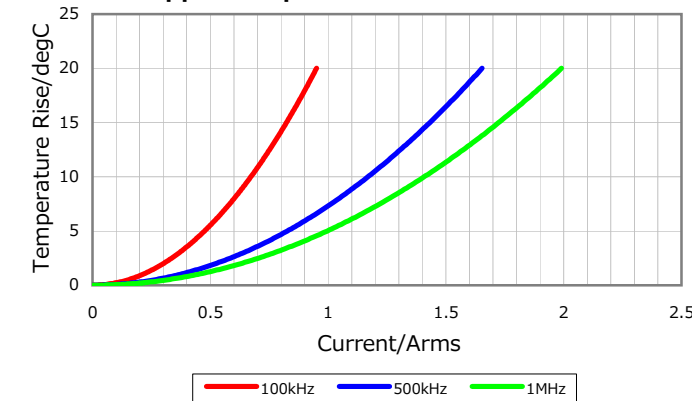

Characterization Sheet (Multilayer Ceramic Chip Capacitors)



All specifications are subject to change without notice.

January 4, 2016