

B45196E, Tantalum, MnO2 Tantalum, 0.22 uF, 10%, 35 V, SMD, Molded, 3216, Height Max = 1.8mm

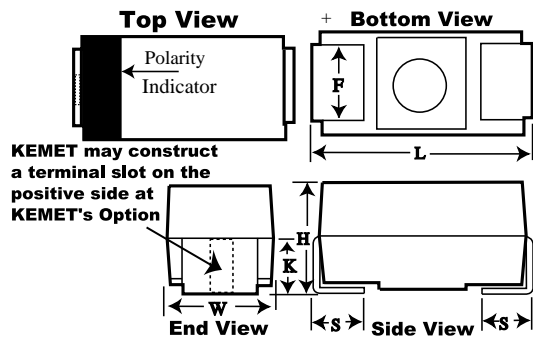

General Information	
Supplier:	KEMET
Series:	B45196E
Dielectric:	MnO2 Tantalum
Style:	SMD Chip
Description:	SMD, Molded
RoHS:	Yes
Termination:	Tin
Notes:	Obsolete. Old Part Number [Obsolete] Was B45196E6224K109

Dimensions	
Footprint	3216
L	3.2mm +/-0.2mm
W	1.6mm +/-0.2mm
H	1.6mm +/-0.2mm
S	0.8mm +/-0.3mm
F	1.2mm +/-0.1mm
K	1.3mm TYP

Specifications	
Capacitance:	0.22 uF
Capacitance Tolerance:	10%
Voltage DC:	35 VDC (85C), 23.45 VDC (125C)
Temperature Range:	-55/+125C
Rated Temperature:	85C
Dissipation Factor:	4%
Failure Rate:	N/A
Leakage Current:	0.5 uA

Packaging Specifications	
Packaging:	T&R, 178mm
Packaging Quantity:	2000