

DESCRIPTION: **RIGHT ANGLE .590" MALE PLASTIC D-SUB**

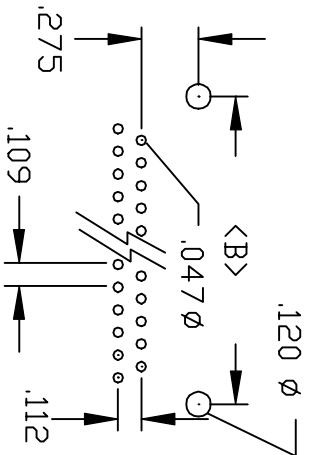

POS.	A	B	C	D	E
09	1.213	0.984	0.452	0.755	0.700
	30.80	24.99	11.48	19.18	17.78
15	1.543	1.312	0.452	1.081	1.402
	39.19	33.32	11.48	27.46	26.47
25	2.087	1.852	0.452	1.635	1.595
	53.00	47.04	11.48	41.53	40.51
37	2.732	2.500	0.452	2.264	2.231
	69.30	63.50	11.48	57.51	56.67

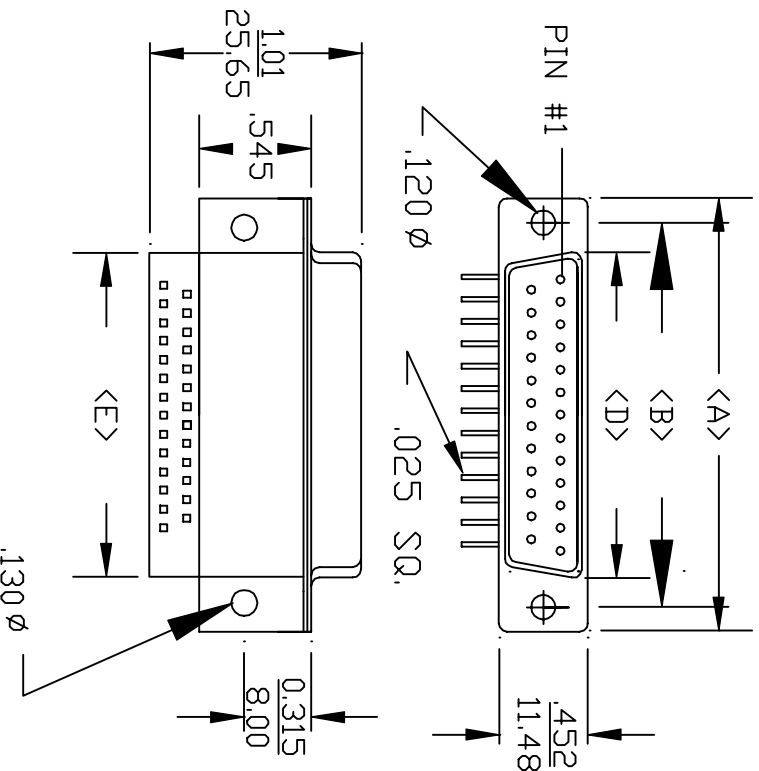
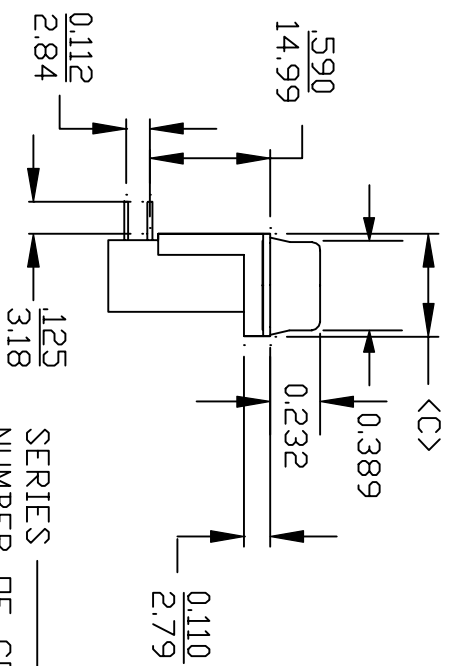

**SPECIFICATIONS:**  
**MATERIALS:**  
 INSULATOR: UL 94V-0 RATED BLACK  
 GLASS FILLED POLYESTER  
 CONTACTS: PHOSPOR BRONZE - GOLD FLASH

**ELECTRICALS:**  
 CURRENT RATING: 5 AMPS  
 DIELECTRIC STRENGTH: 1000V AC RMS  
 INSULATION RESISTANCE: 1000 meg OHMS  
 CONTACT RESISTANCE: 10 MILLIOHMS MAX.  
 TEMPERATURE: -55°C TO +105°C

SERIES \_\_\_\_\_  
 NUMBER OF CONTACTS \_\_\_\_\_  
 GENDER: \_\_\_\_\_  
 1 = MALE  
 2 = FEMALE  
 PC MOUNT \_\_\_\_\_  
 SHELL MATERIAL \_\_\_\_\_  
 0 = ALL PLASTIC

HARDWARE OPTIONS: \_\_\_\_\_  
 (SEE PAGE 2)  
 PLATING: \_\_\_\_\_  
 1 = GOLD FLASH

THESE DRAWINGS AND SPECIFICATIONS ARE THE PROPERTY OF NorComp AND SHALL NOT BE REPRODUCED, COPIED OR USED AS THE BASIS FOR THE MANUFACTURE OR SALE OF APPARATUS WITHOUT WRITTEN PERMISSION.

DRAWN: **PAM JENKINS** DATE: **9-23-98**

CHECKED: \_\_\_\_\_ DATE: \_\_\_\_\_

SCALE: \_\_\_\_\_ SHEET **1** OF **2** REV **5**

**NorComp**

DWG NO. **177-XXX-110-XX1**

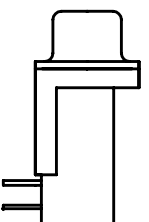
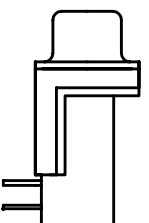
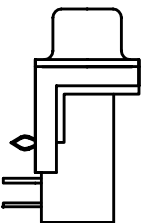
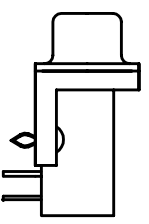
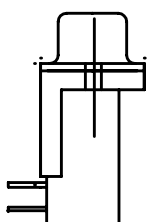
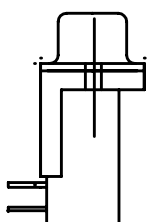
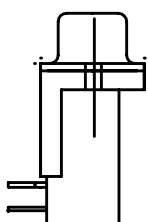
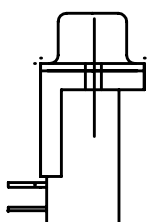
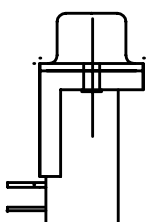
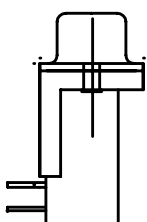
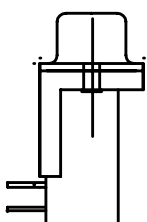
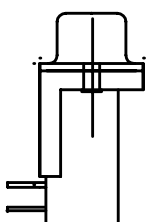
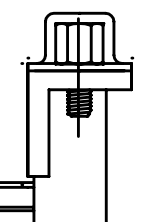
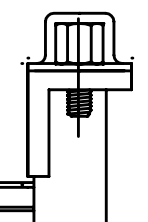
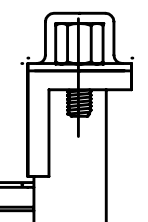
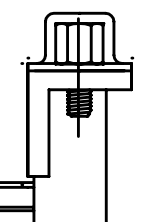
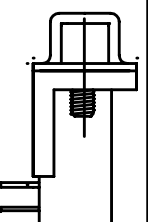
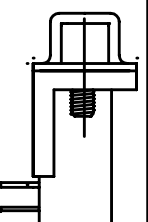
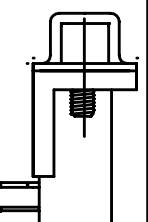
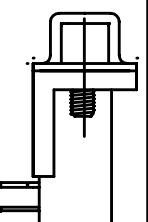
	PLASTIC SHELL		METAL SHELL WITH INSIDE GROUND STRAPS		METAL SHELL WITH RETAINING CLIP GROUND		PLASTIC SHELL WITH PLASTIC SNAP LOCK
	06		16		36		S6
	07		17		37		S7
	08		18		38		S8
	09		19		39		S9 with washers

	THESE DRAWINGS AND SPECIFICATIONS ARE THE PROPERTY OF NorComp AND SHALL NOT BE REPRODUCED, COPIED OR USED AS THE BASIS FOR THE MANUFACTURE OF APPARATUS WITHOUT WRITTEN PERMISSION.		DRAWN: PAM JENKINS	DATE: 11-3-98
	SCALE:	CHECKED:	DATE:	
NorComp	DWG NO.	SHEET 2 OF 2	REV 3	
	177 SERIES HARDWARE			