

Sup/IRBuck™

USER GUIDE FOR IR3832W EVALUATION BOARD

DESCRIPTION

The IR3832W is a synchronous buck converter, providing a compact, high performance and flexible solution in a small 5mmx6mm Power QFN package.

Key features offered by the IR3832W include programmable soft-start ramp, Power Good, thermal protection, programmable switching frequency, tracking input, enable input, input under-voltage lockout for proper start-up, and pre-bias start-up.

An output over-current protection function is implemented by sensing the voltage developed across the on-resistance of the synchronous rectifier MOSFET for optimum cost and performance.

This user guide contains the schematic and bill of materials for the IR3832W evaluation board. The guide describes operation and use of the evaluation board itself. Detailed application information for IR3832W is available in the IR3832W data sheet.

BOARD FEATURES

- $V_{in} = +12V$ (13.2V Max)
- $V_{cc} = +5V$ (5.5V Max)
- $V_{out} = +0.75V @ 0- \pm 4A$
- $F_s = 400kHz$
- $L = 1.50\mu H$
- $C_{in} = 2 \times 10\mu F$ (ceramic 1206) + $330\mu F$ (electrolytic)
- $C_{out} = 6 \times 22\mu F$ (ceramic 0805)

CONNECTIONS and OPERATING INSTRUCTIONS

A well regulated +12V input supply should be connected to VIN+ and VIN-. A maximum ±4A load should be connected to VOUT+ and VOUT-. The connection diagram is shown in Fig. 1 and inputs and outputs of the board are listed in Table I.

IR3832W has two input supplies, one for biasing (Vcc) and the other as input voltage (Vin). Separate supplies should be applied to these inputs. Vcc input should be a well regulated 4.5V-5.5V supply and it would be connected to Vcc+ and Vcc-.

If single 12V application is required, connect R7 (zero Ohm resistor) which enables the on board bias regulator (see schematic). In this case there is no need of external Vcc supply.

The output tracks VDDQ input. The value of R14 and R28 can be selected to provide the desired ratio between the output voltage and the tracking input. *For proper operation of IR3832W, the voltage at Vp pin should not exceed Vcc.*

Table I. Connections

Connection	Signal Name
VIN+	V _{in} (+12V)
VIN-	Ground of V _{in}
Vcc+	Vcc input
Vcc-	Ground for Vcc input
VOUT-	Ground of V _{out}
VOUT+	V _{out} (+0.75V)
Enable	Enable
V _{DDQ}	Tracking Input
PGood	Power Good Signal

LAYOUT

The PCB is a 4-layer board. All of layers are 2 Oz. copper. The IR3832W SupIRBuck and all of the passive components are mounted on the top side of the board.

Power supply decoupling capacitors, the Bootstrap capacitor and feedback components are located close to IR3832W. The feedback resistors are connected to the output voltage at the point of regulation and are located close to the SupIRBuck. To improve efficiency, the circuit board is designed to minimize the length of the on-board power ground current path.

Connection Diagram

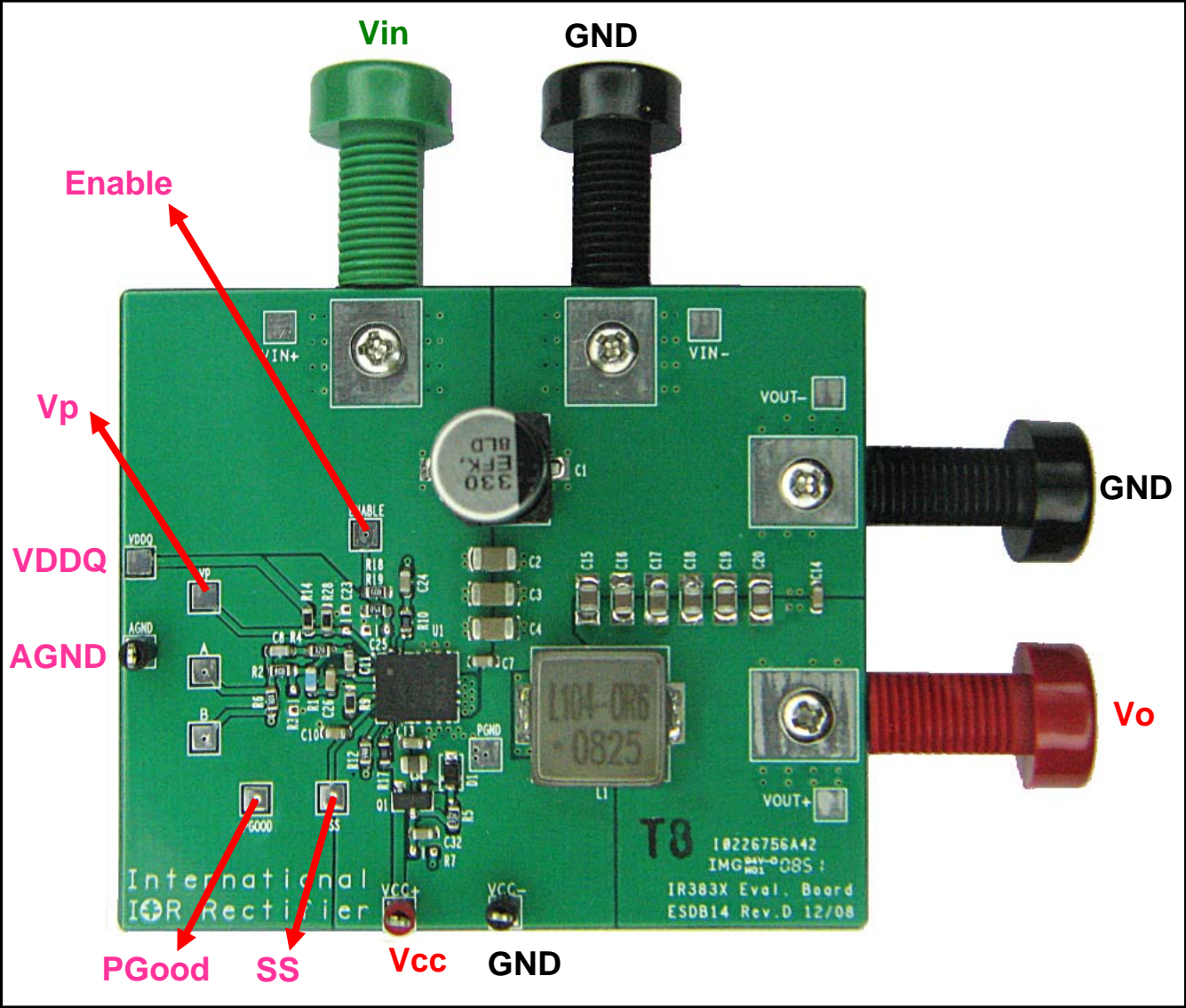

Fig. 1: Connection diagram of IR383xW evaluation boards

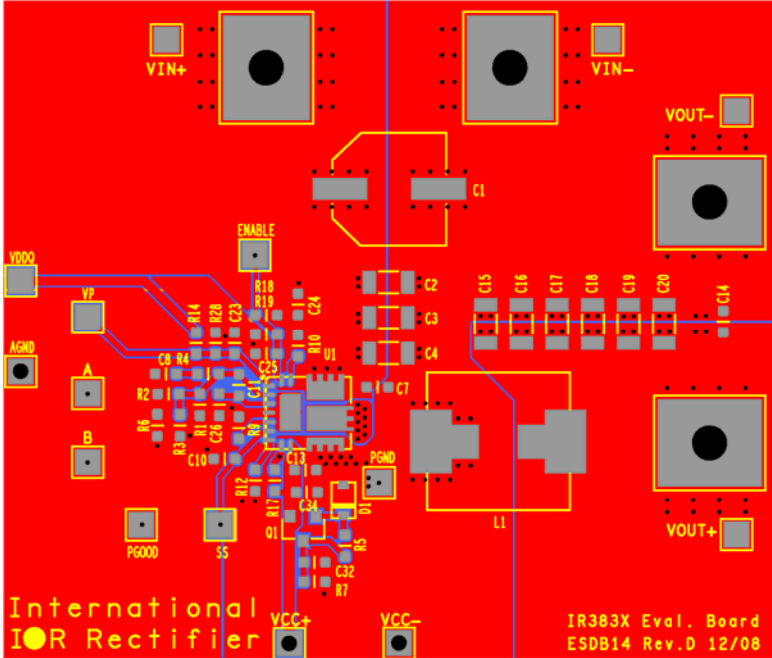

Fig. 2: Board layout, top overlay

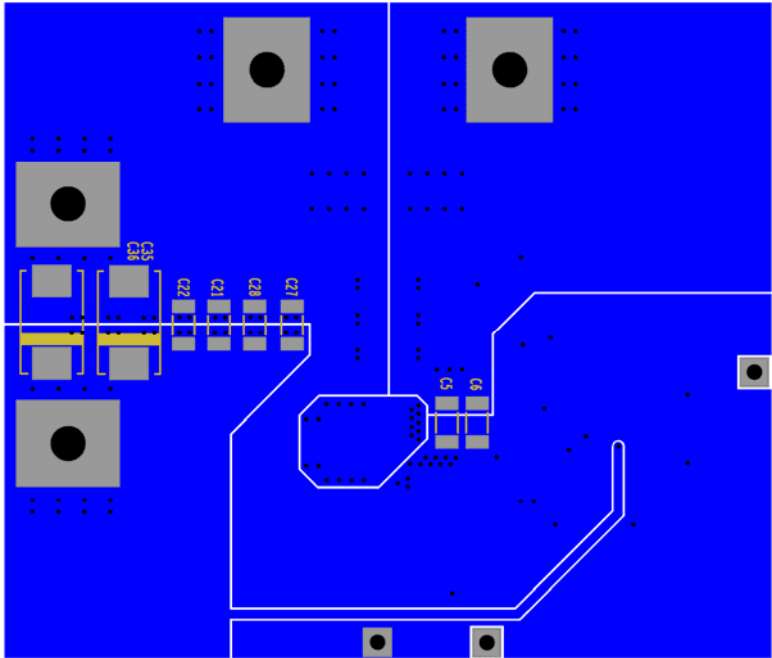

Fig. 3: Board layout, bottom overlay

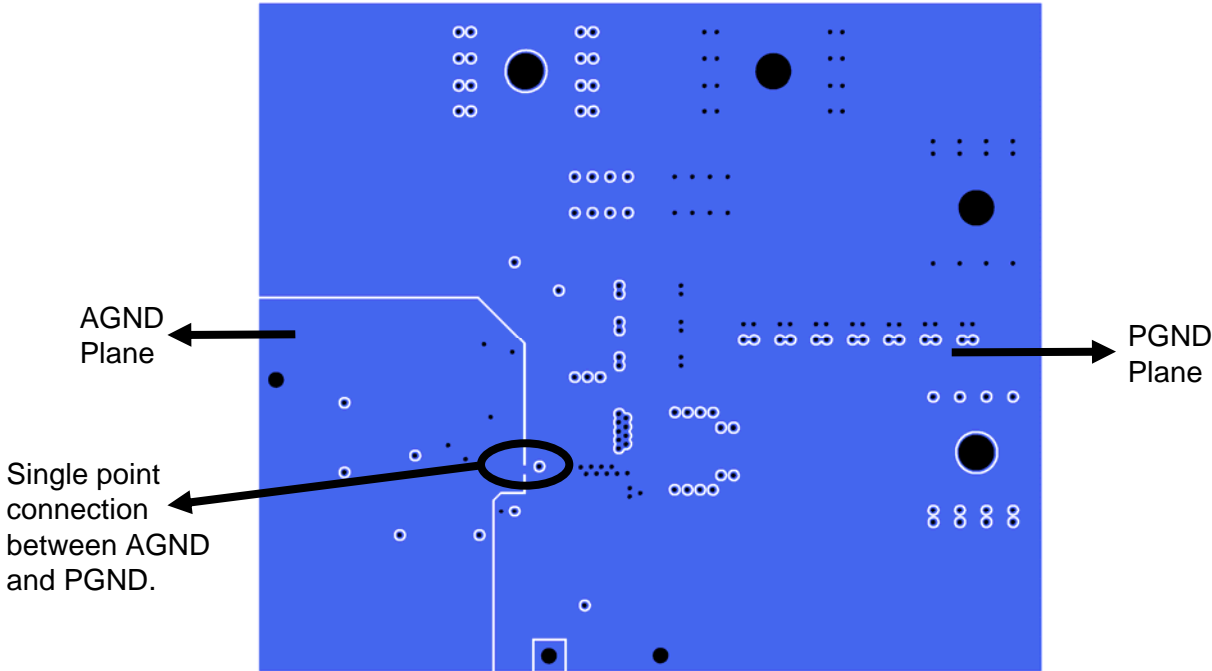

Fig. 4: Board layout, mid-layer I

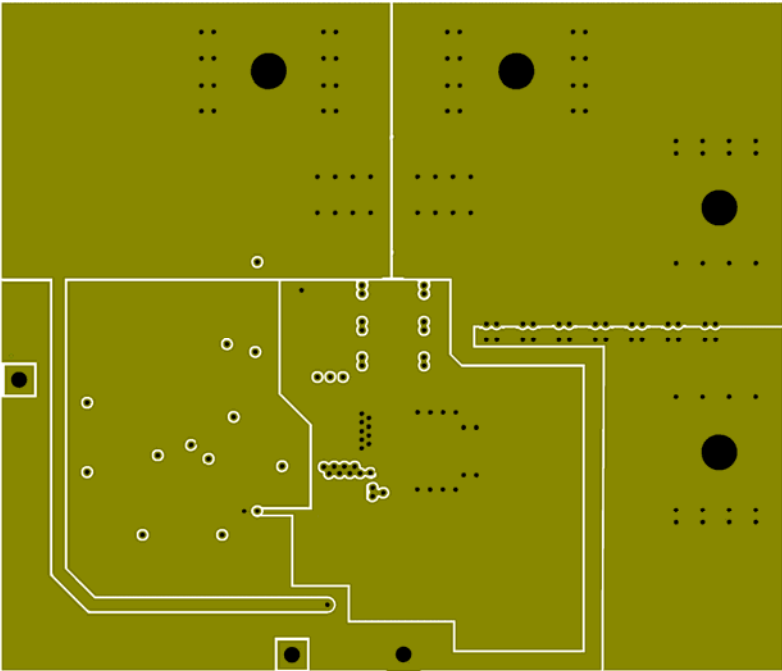
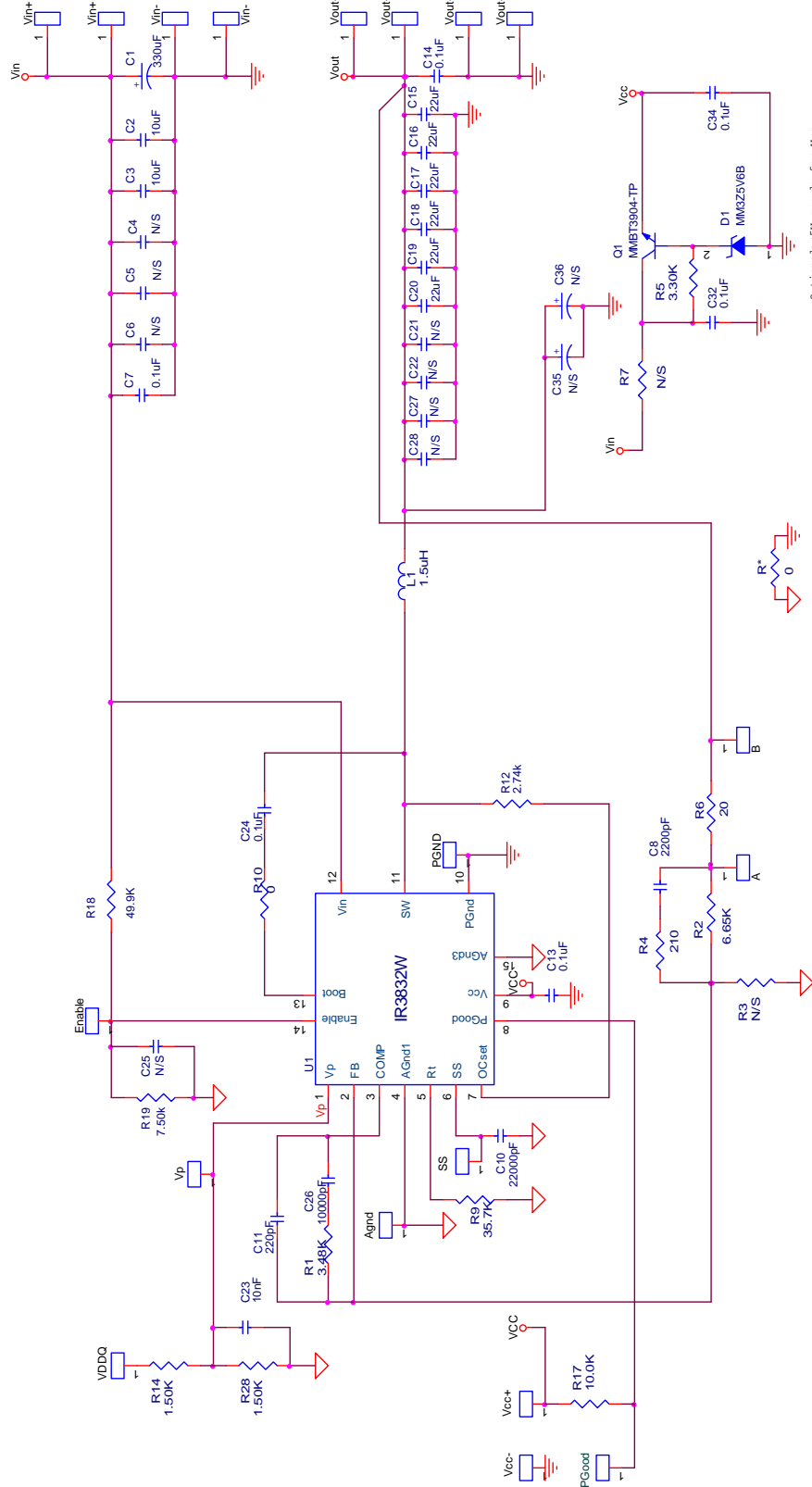

Fig. 5: Board layout, mid-layer II



Single point of connection between Power Ground and Signal ("analog") Ground

Fig. 6: Schematic of the IR3832W evaluation board

Bill of Materials

Item	Quantity	Part Reference	Value	Description	Manufacturer	Part Number
1	1	C1	330uF	SMD Electrolytic, Fsize, 25V, 20%	Panasonic	EEV-FK1E331P
2	2	C2 C3	10uF	1206, 16V, X5R, 20%	Panasonic - ECG	ECJ-3YB1C106M
3	1	C10	0.022uF	0603, 16V, X7R, 10%	Panasonic - ECG	ECJ-1VB1C223K
4	1	C34	10uF	0805, 10V, X5R, 20%	Panasonic - ECG	ECJ-GVB1A106M
5	5	C7 C13 C14 C24 C32	0.1uF	0603, 25V, X7R, 10%	Panasonic - ECG	ECJ-1VB1E104K
6	1	C8	2200pF	0603, 50V, NP0, 5%	Murata	GRM1885C1H222JA01D
7	1	C11	220pF	0603, 50V, NP0, 5%	Panasonic - ECG	ECJ-1VC1H221J
8	6	C15 C16 C17 C18 C19 C20	22uF	0805, 6.3V, X5R, 20%	Panasonic - ECG	ECJ-2FB0J226M
9	2	C25, C26	10000pF	0603, 50V, X7R, 10%	Panasonic - ECG	ECJ-1VB1H103K
10	1	D1	MM3Z5V6B	Zener, 5.6V	Fairchild	MM3Z5V6B
11	1	L1	1.5uH	11.5x10x4mm, 20%, 3.9mOhm	Delta	MPO104-1R51R
12	1	Q1	MMBT3904/SOT	NPN, 40V, 200mA, SOT-23	Fairchild	MMBT3904/SOT
13	1	R5	3.3k	Thick Film, 0603, 1/10W, 1%	Rohm	MCR03EZPFX3301
14	1	R18	49.9k	Thick Film, 0603, 1/10W, 1%	Rohm	MCR03EZPFX4992
15	1	R4	210	Thick Film, 0603, 1/10W, 1%	Panasonic - ECG	ERJ-3EKF2100V
16	1	R6	20	Thick Film, 0603, 1/10 W, 1%	Vishey/Dale	CRCW060320R0FKEA
17	1	R9	35.7k	Thick Film, 0603, 1/10W, 1%	Rohm	MCR03EZPFX3572
18	1	R12	2.74k	Thick Film, 0603, 1/10 W, 1%	Rohm	MCR03EZPFX2741
19	1	R17	10.0k	Thick Film, 0603, 1/10W, 1%	Rohm	MCR03EZPFX1002
20	1	R19	7.5k	Thick Film, 0603, 1/10W, 1%	Rohm	MCR03EZPFX7501
21	1	R10	0	Thick Film, 0603, 1/10W, 1%	Yageo	RC0603FR-100RL
22	1	R1	3.48k	Thick Film, 0603, 1/10W, 1%	Rohm	MCR03EZPFX3481
23	1	R2	6.65k	Thick Film, 0603, 1/10W, 1%	Rohm	MCR03EZPFX6651
24	2	R14, R28	1.50k	Thick Film, 0603, 1/10W, 1%	Rohm	MCR03EZPFX1501
25	1	U1	IR3832W	4A SuplIRBuck, 6mmx5mm	International Rectifier	IR3832WMPbF

TYPICAL OPERATING WAVEFORMS

Vin=12.0V, Vcc=5V, Vo=0.75V, Io=0- ±4A, Room Temperature, No Air Flow

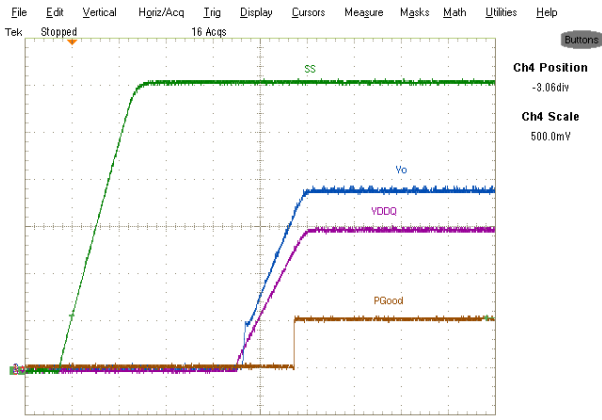

Fig. 7: Start up at 4A, sourcing current
Ch₁:PGood, Ch₂:V_{out}, Ch₃:V_{DDQ}, Ch₄:SS

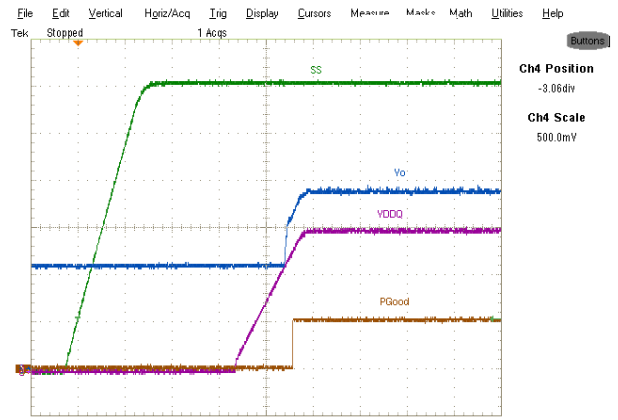

Fig. 8: Start up with Prebias, 0A Load
Ch₁:PGood, Ch₂:V_{out}, Ch₃:V_{DDQ}, Ch₄:SS

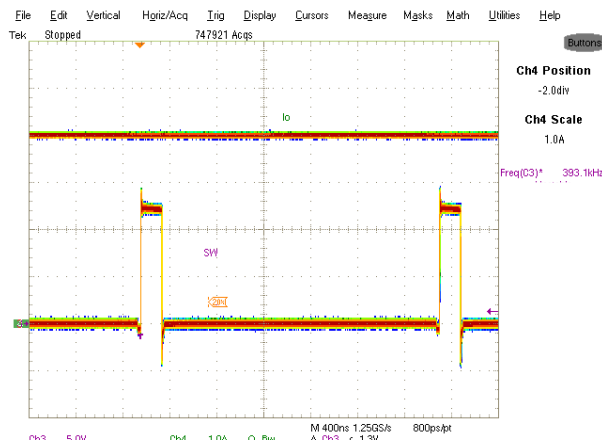

Fig. 9: Inductor node at 4A, sourcing current, Ch₃:SW, Ch₄:I_{out}

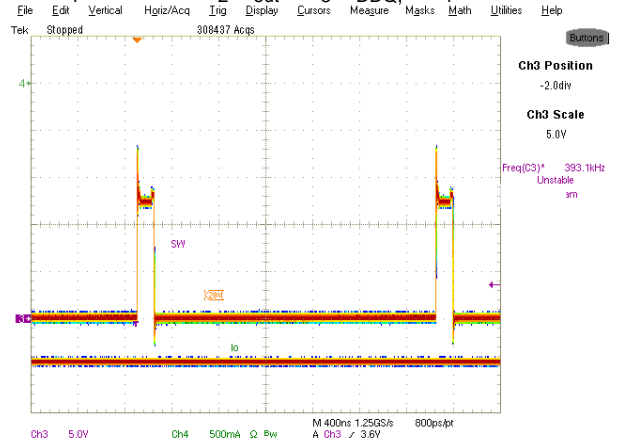

Fig. 10: Inductor node at -3A, sinking current, Ch₃:SW, Ch₄:I_{out}

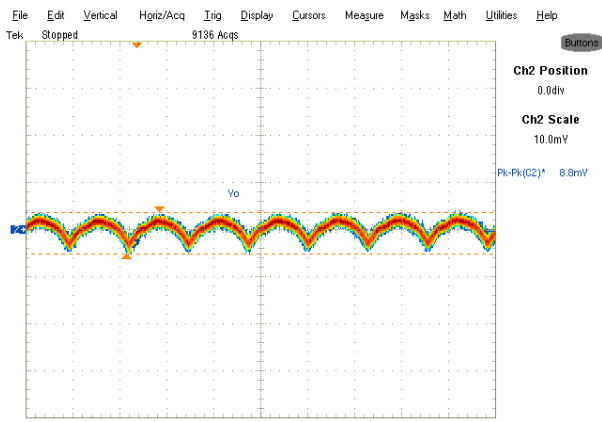

Fig. 11: Output Voltage Ripple, 4A, sourcing current, Ch₂:V_{out}

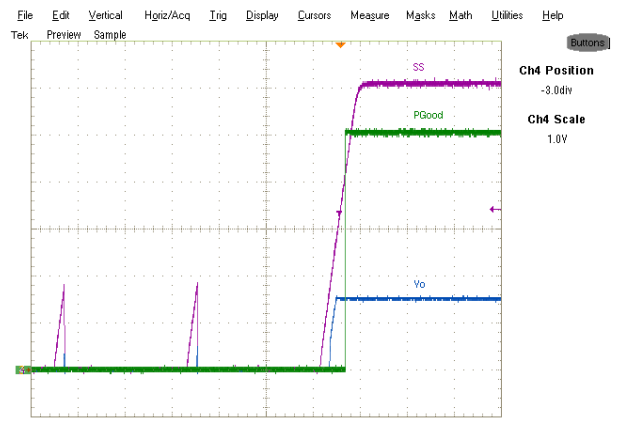

Fig. 12: Short (Hiccup) Recovery
Ch₂:V_{out}, Ch₃:V_{SS}, Ch₄:PGood

TYPICAL OPERATING WAVEFORMS

Vin=12V, Vcc=5V, Vo=0.75V, Room Temperature, No Air Flow

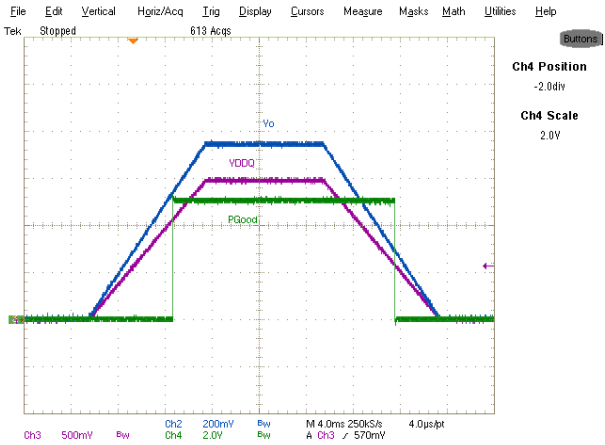

Fig. 13: Tracking 4A, sourcing current, Ch2:V_{out}, Ch3:V_{DDQ}, Ch4:PGood

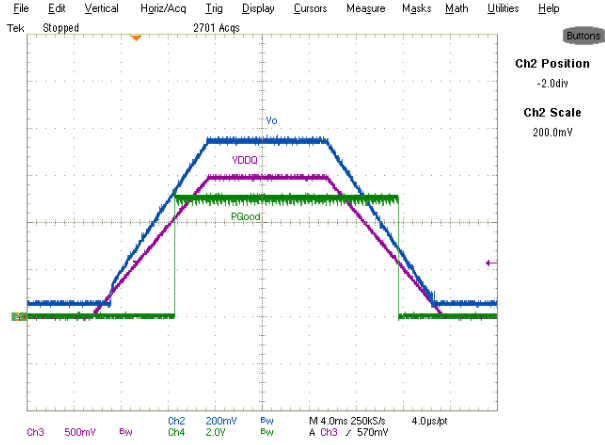

Fig. 14: Tracking -3A load, sinking current, Ch2:V_{out}, Ch3:V_{DDQ}, Ch4:PGood

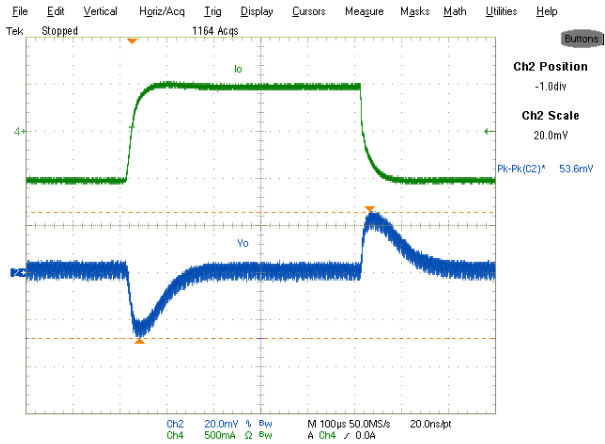

Fig. 15: Transient Response, 1A/us -0.5A to +0.5A load, Ch2:V_{out}, Ch4:I_o

TYPICAL OPERATING WAVEFORMS

Vin=12V, Vcc=5V, Vo=0.75V, Io=+4A, Room Temperature, No Air Flow

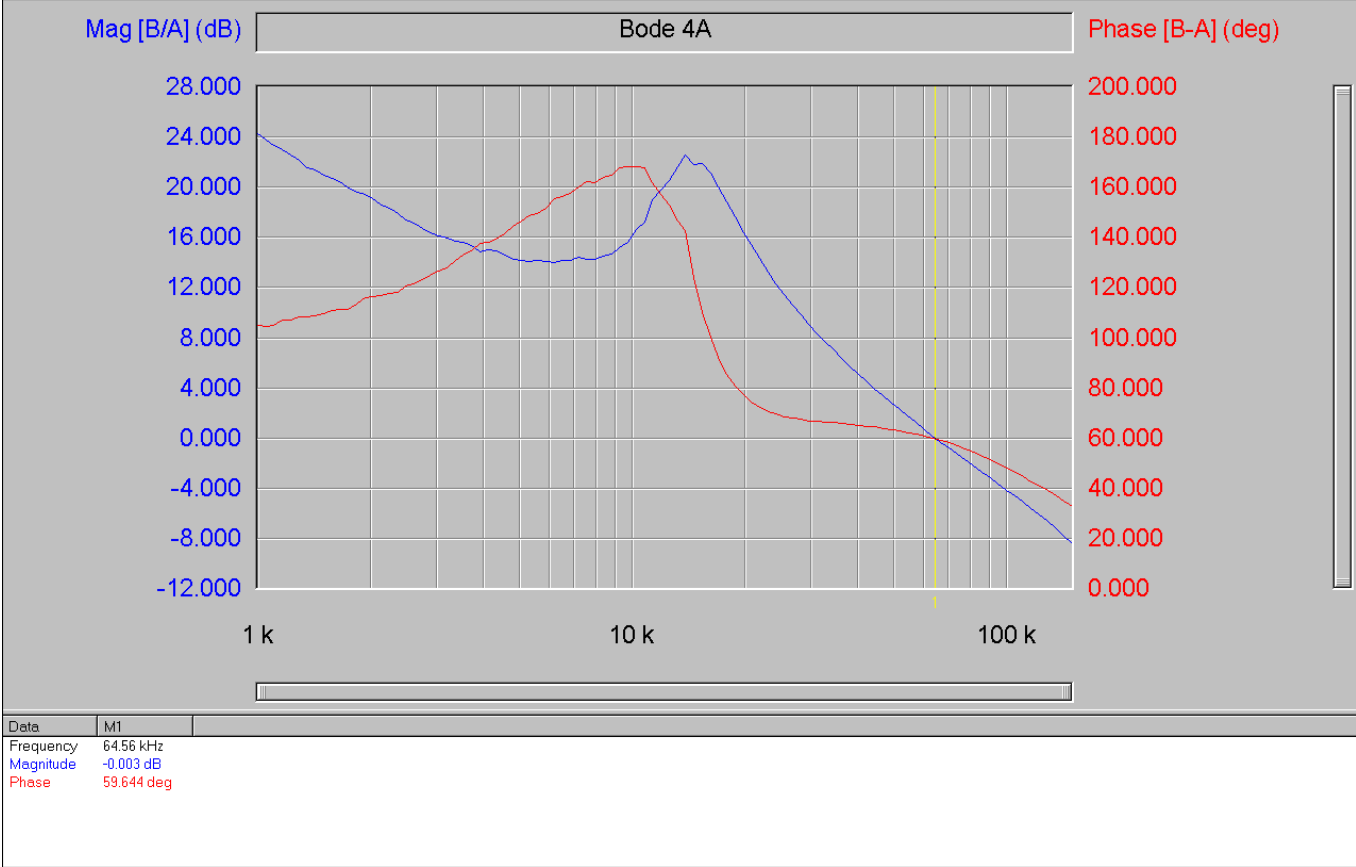

Fig.16: Bode Plot at 4A load (sourcing current) shows a bandwidth of 65kHz and phase margin of 60 degrees

TYPICAL OPERATING WAVEFORMS

Vin=12V, Vo=0.75V, Io=0- +4A, Room Temperature, No Air Flow

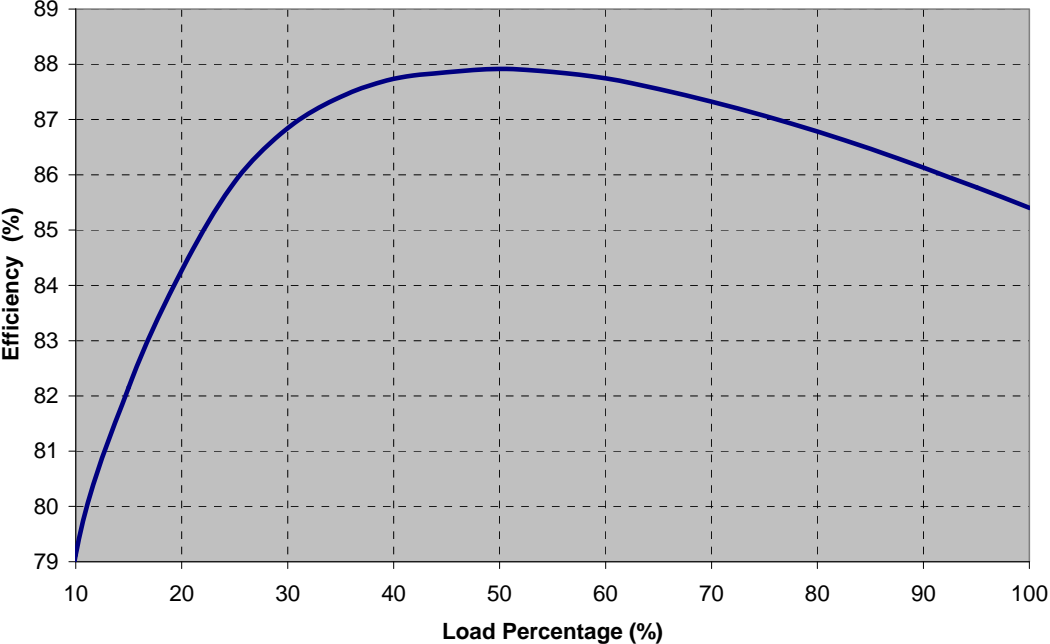

Fig.17: Efficiency versus load current

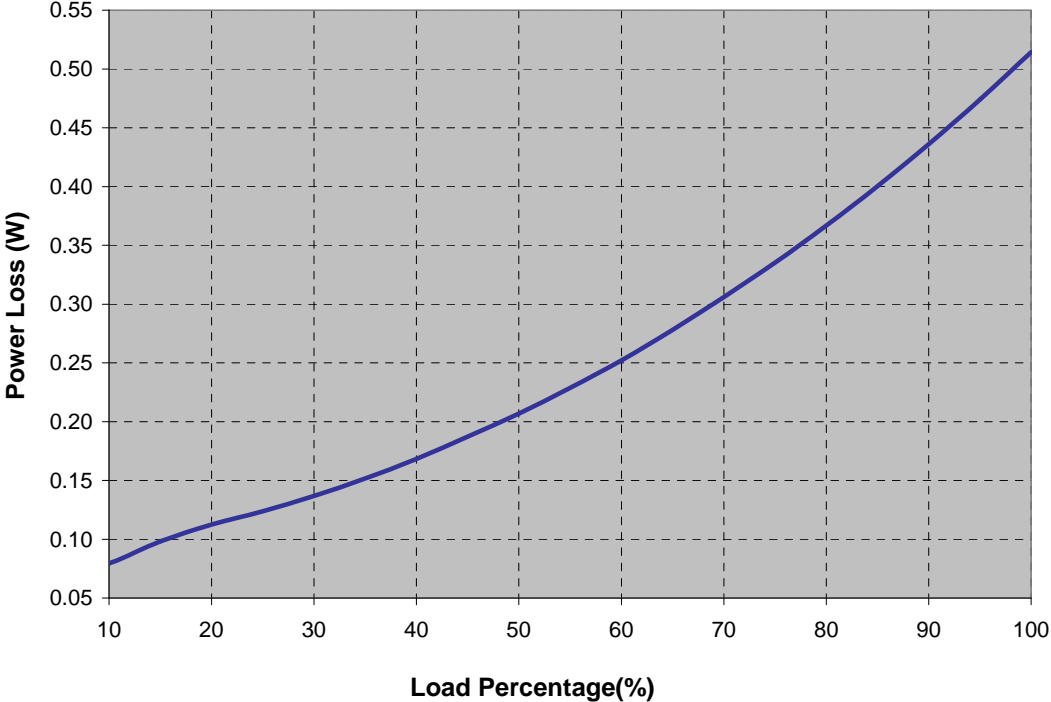

Fig.18: Power loss versus load current

THERMAL IMAGES

Vin=12V, Vo=0.75V, Io=+4A, Room Temperature, No Air Flow



Fig.19: Thermal Image at 4A load
Test Point 1: IR3832W, Test Point 2: Inductor

PCB Metal and Components Placement

The lead lands (the 11 IC pins) width should be equal to the nominal part lead width. The minimum lead to lead spacing should be $\geq 0.2\text{mm}$ to minimize shorting.

Lead land length should be equal to the maximum part lead length + 0.3 mm outboard extension. The outboard extension ensures a large and inspectable toe fillet.

The pad lands (the 4 big pads other than the 11 IC pins) length and width should be equal to maximum part pad length and width. However, the minimum metal to metal spacing should be no less than 0.17mm for 2 oz. Copper; no less than 0.1mm for 1 oz. Copper and no less than 0.23mm for 3 oz. Copper.

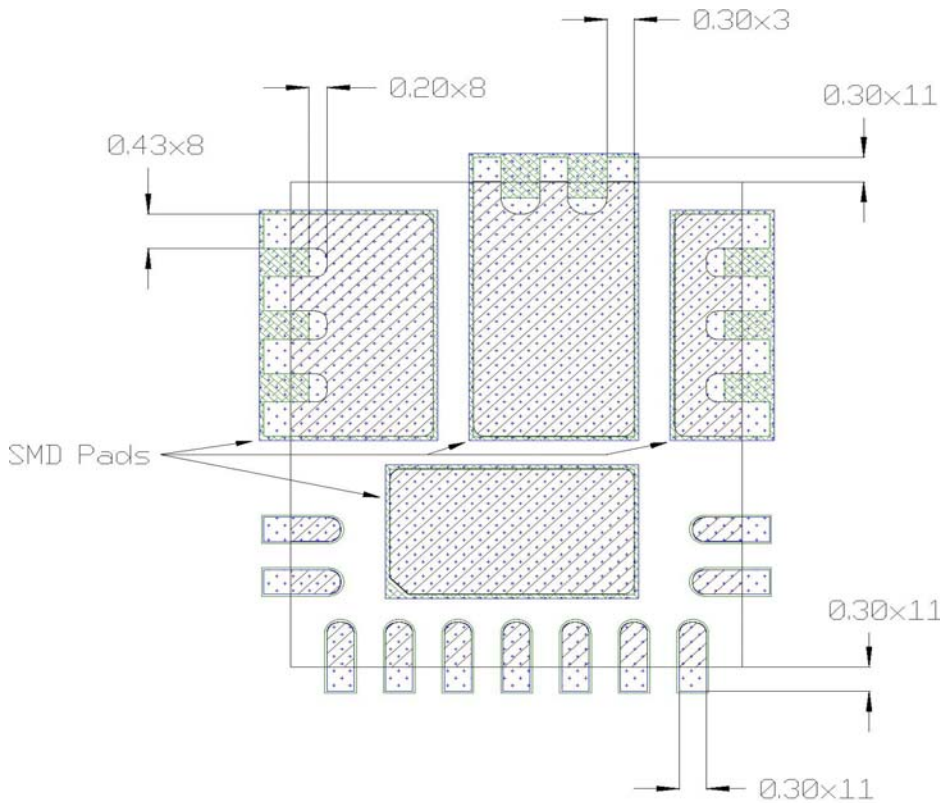

All Dimensions in mm

-  PCB Copper
-  Component pad
-  Soldermask

Solder Resist



It is recommended that the lead lands are Non Solder Mask Defined (NSMD). The solder resist should be pulled away from the metal lead lands by a minimum of 0.025mm to ensure NSMD pads.

The land pad should be Solder Mask Defined (SMD), with a minimum overlap of the solder resist onto the copper of 0.05mm to accommodate solder resist mis-alignment.

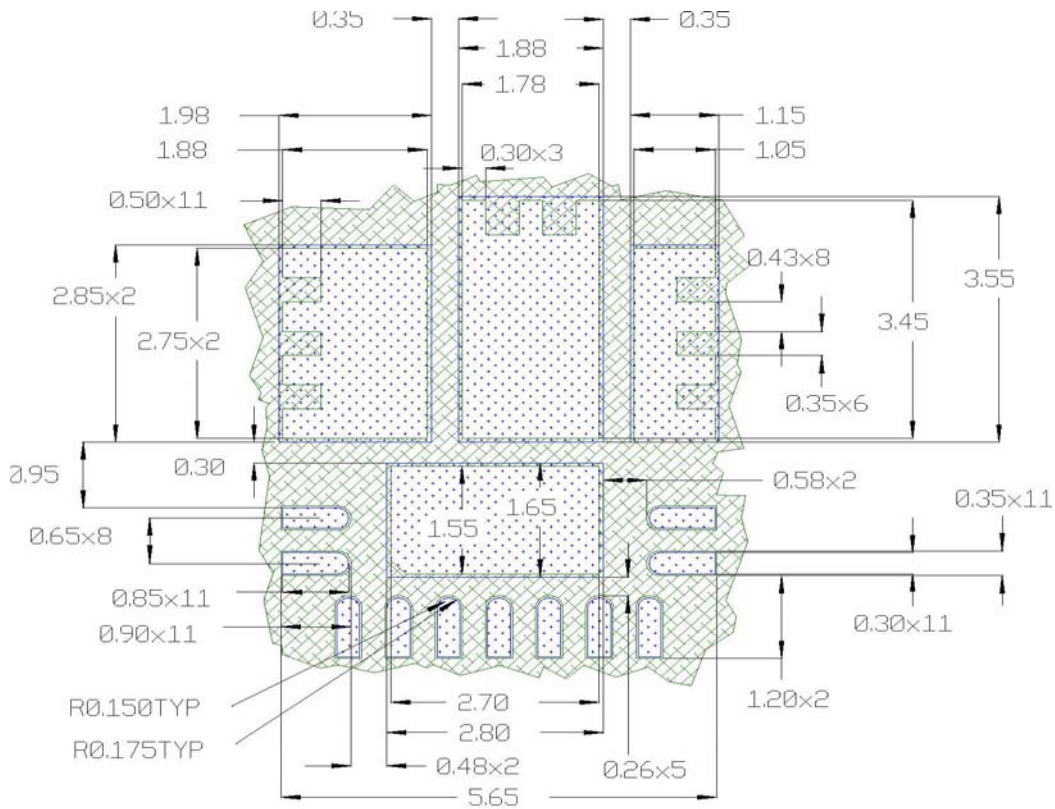
Ensure that the solder resist in between the lead lands and the pad land is $\geq 0.15\text{mm}$ due to the high aspect ratio of the solder resist strip separating the lead lands from the pad land.



All Dimensions in mm

-  PCB Copper
-  PCB Solder Resist

Stencil Design

- The Stencil apertures for the lead lands should be approximately 80% of the area of the lead lands. Reducing the amount of solder deposited will minimize the occurrences of lead shorts. If too much solder is deposited on the center pad the part will float and the lead lands will be open.
- The maximum length and width of the land pad stencil aperture should be equal to the solder resist opening minus an annular 0.2mm pull back to decrease the incidence of shorting the center land to the lead lands when the part is pushed into the solder paste.

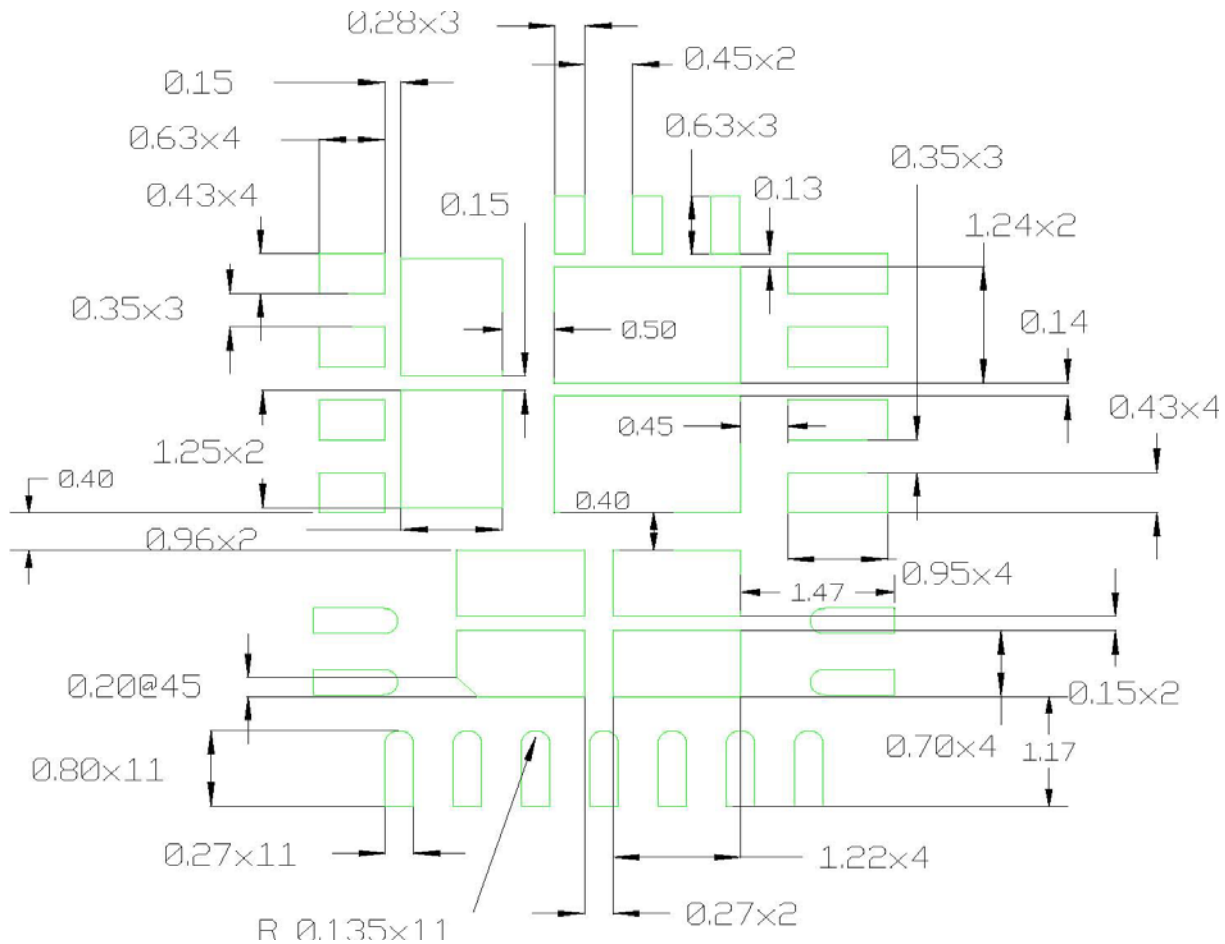

Stencil Aperture
 All Dimensions in mm

