

Introduction

The progress in many parts of modern power systems such as DDR/Chipset core voltage regulators, high current low voltage DC/DC converters, FPGA/ASIC DC/DC converters and many other general purpose applications keeps challenging the power management IC makers to come up with innovative products and new solutions to meet the increase in power, reduction in size and increase in the DC/DC converter's efficiency targets. The interleaved multiphase synchronous buck topology proves again to be the topology of choice for such high current low voltage applications.

The ISL6310 is a space-saving, cost-effective solution for such applications. The ISL6310 is a two-phase PWM control IC with integrated high current MOSFET drivers. The integration of 5V to 12V high current MOSFET drivers into the controller IC marks a departure from the separate PWM controller and driver configuration of previous multi-phase product families. By reducing the number of external parts, this integration allows for a cost and space saving power management solution.

Output voltage can be programmed using the on-chip DAC or an external precision reference. A two bit code programs the DAC reference to one of 4 possible values (0.6V, 0.9V, 1.2V and 1.5V). A unity gain, differential amplifier is provided for remote voltage sensing, compensating for any potential difference between remote and local grounds. The output voltage can also be offset through the use of single external resistor. An optional droop function is also implemented and can be disabled for applications having less stringent output voltage variation requirements or experiencing less severe step loads.

A unique feature of the ISL6310 is the combined use of both DCR and $r_{DS(ON)}$ current sensing. Load line voltage positioning and overcurrent protection are accomplished through continuous inductor DCR current sensing, while $r_{DS(ON)}$ current sensing is used for accurate channel-current balance. Using both methods of current sampling utilizes the best advantages of each technique.

Protection features of this controller IC include a set of sophisticated overvoltage and overcurrent protection. Overvoltage results in the converter turning the lower MOSFETs ON to clamp the rising output voltage and protect the load. An OVP output is also provided to drive an optional crowbar device. The overcurrent protection level is set through a single external resistor. Other protection features include protection against an open circuit on the remote sensing inputs. Combined, these features provide advanced protection for the output load.

The ISL6310EVAL1Z evaluation board embodies a 55A to 60A regulator solution targeted at supplying power to the designated load. The physical board design is optimized for 2 phase operation and ships out configured to provide one of the following four output voltages (0.6V, 0.9V, 1.2V and 1.5V) depending on choice of the REF1, REF0 combination set by DIP switch U2, but can be easily modified to provide any output voltage values in the range of 0.6V to 2.3V by means of resistor divider composed of R90, R81.

For further details on the ISL6310, consult the data sheet [1].

The Intersil multi-phase family controller and driver portfolio continues to expand with new selections to better fit our customer's needs. Refer to our web site for updated information: www.intersil.com.

ISL6310EVAL1Z Board Design

The evaluation kit consists of the ISL6310EVAL1Z evaluation board, the ISL6310 data sheet, and this application note. The evaluation board is optimized for two phase operation without droop, the nominal output voltage is 1.5V (with DIP switch U2 set to 11 position) and the maximum output current is 60A.

The evaluation board provides convenient test points, a DIP switch for DAC (REF) voltage selection from four possible values (0.6V, 0.9V, 1.2V and 1.5V), footprint for a resistor divider for output voltage adjustment up to 2.3V, and an on-board transient load generator to facilitate the evaluation process. An on board LED is present to indicate the status of the PGOOD signal. The board is configured for down conversion from 5V to 12V to the REF setting.

The printed circuit board is implemented in 6-layer, 2-ounce copper. Layout plots and part lists are provided at the end of the application note for this design.

Quick Start Evaluation

The ISL6310EVAL1Z is designed for quick evaluation after following only a few simple steps. All that is required is two bench power supplies, Oscilloscope and Load. To begin evaluating the ISL6310EVAL1Z follow the steps below.

1. Before doing anything to the evaluation board, make sure the "Enable" switch (S1) and the "Transient Load Generator" switch (S2) are both in the ON position corresponding to the converter being disabled and the transient load generator being turned off.
2. Connect a 12V, 10A Lab power supply between J7 and J8, this Power supply provides VIN and PVCC (with original board configuration).

3. Connect a 5V, 1A Lab power supply between J23 and GND, this Power supply provides VCC bias (and PVCC bias if the board is configured for 5V PVCC).
4. Set the "REF Selection" DIP switch (U2) to 11 corresponding to DAC = REF = 1.5V. Figure 1 details the typical default configuration for U2 when the board is received. In this default setting, the evaluation board is set for a reference voltage of 1.5V.

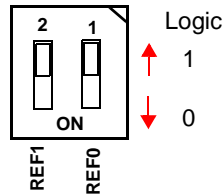

FIGURE 1. TYPICAL U2 DEFAULT SETTING 11 (1.500V)

5. Connect a load (either resistive or electronic) between V_{OUT} terminal (J1, J2) and GND terminal (J3, J4).
6. Move the "Enable" switch (S1) to the OFF position releasing the IC ENLL pin to rise to begin regulation.

After step 6, the ISL6310EVAL1Z should be regulating the output voltage, at the " V_{OUT+} " and " V_{OUT-} " test points (P20, P21) and J5 to the REF voltage. The "PGOOD Indicator" LED (D1) should be green to indicate the regulator is operating correctly.

ISL6310EVAL1Z Board Features

Input Power Connections

The ISL6310EVAL1Z allows for the use of standard bench power supplies for powering up the board. Two female-banana jacks are provided for connection of bench power supplies. Connect the +5V terminal to P23, +12V terminal to J7, and the common ground to terminal J8. Voltage sequencing is not required when powering the evaluation board.

Once power is applied to the board, the PGOOD LED indicator will begin to illuminate red. With S1 in the ON position, the ENABLE input of the ISL6310 is held low and the startup sequence is inhibited.

Output Power Connections

The ISL6310EVAL1Z output can be exercised using either resistive or electronic loads. Copper alloy terminal lugs provide connection points for loading. Tie the positive load connection to V_{OUT+} terminals J1 and J2, and the negative to ground, terminals J3 and J4. A shielded scope probe test point, J5, allows for inspection of the output voltage, V_{OUT+} .

REF and V_{OUT} Setup

The REF DIP switch would be preset to 11 (1.500V). Also 1.2V, 0.9V and 0.6V outputs can be selected using different codes on the DIP switch. If an output voltage different than the 4 possible REF values is desired, the output resistor divider composed of R90 (initially 0Ω) and R81 (initially

open) can be used (consult Data sheet and the section entitled "Adjusting the Output Voltage" on page 8 for resistor value calculations). Note that the ISL6310 is usable for output voltages up to 2.3V when the REF voltage is set to 1.5V. See Table 1 below for the maximum possible voltages with different REF setting.

TABLE 1. MAXIMUM OUTPUT VOLTAGE WITH DIFFERENT REF SETTING WITH THE USE OF A RESISTOR DIVIDER ON VSEN

REF1	REF0	REF = DAC	$V_{OUT MAX}$
0	0	0.6V	1.4V
0	1	0.9V	1.7V
1	0	1.2V	2.0V
1	1	1.5V	2.3V

PVCC Power Options

One unique feature of the ISL6310 is the variable gate drive bias for the integrated drivers. The gate drive voltage for the internal drivers can be any voltage from +5V to +12V by simply connecting the desired voltage to the PVCC pin of the controller. To accommodate the flexibility of the drivers, the ISL6310EVAL1Z has been designed to support a multitude of options for the PVCC voltage.

Switching between the different PVCC voltages available on the evaluation board is as simple as populating and depopulating certain resistors. The eval board has three on board voltages available: +5V, +12V, and +8V (from an on board linear regulator). Refer to Table 2 for what resistors to populate for each voltage option.

TABLE 2. GATE DRIVE VOLTAGE OPTIONS AND RESISTOR SETTINGS

UGATE VOLTAGE	LGATE VOLTAGE	R48	R68	R71	R72
12.0V	12.0V	OPEN	OPEN	OPEN	0Ω
8.0V	8.0V	OPEN	OPEN	0Ω	OPEN
5.0V	5.0V	0Ω	OPEN	OPEN	OPEN
12.0V	5.0V	0Ω	0Ω	OPEN	OPEN

Enabling the Controller

In order to enable the controller, the board must be powered, a REF (DAC) code must be set, and the PVCC and VCC voltages must be set. If these steps have been properly followed, the regulator is enabled by toggling the "ENABLE" switch (S1) to the OFF position. When S1 is switched OFF, the voltage on the ENLL pin of the ISL6310 will rise above the ENLL threshold of 0.66V and the controller will begin its digital soft start sequence. The output voltage ramps up to the programmed setting, at which time the PGOOD indicator will switch from red to green.

On-Board Load Transient Generator

Most bench-top electronic loads are not capable of producing the current slew rates required to emulate most modern loads. For this reason, a discrete transient load generator is provided on the evaluation board, see Figure 2. The generator produces a load pulse of 500µs in duration with a period of 27ms. The pulse magnitude is approximately 25A with rise and fall slew rates of approximately 50A/µs as configured. The short load current pulse and long duty cycle is required to limit the power dissipation in the load resistors (R38-R42) and MOSFETs (Q20, Q21). To engage the load generator simply place switch S2, in the “OFF” position.

If the DAC code is changed from 11(1.500V), the transient generator dynamics must be adjusted relative to the new output voltage level. Place a scope probe in J10 to measure the voltage across the load resistors and the dV/dt across them as well. Adjust the load resistors, R38-R40, to achieve the correct load current level. Change resistors R34-R37 to increase or decrease the dV/dt as required to match the desired dI/dt profile.

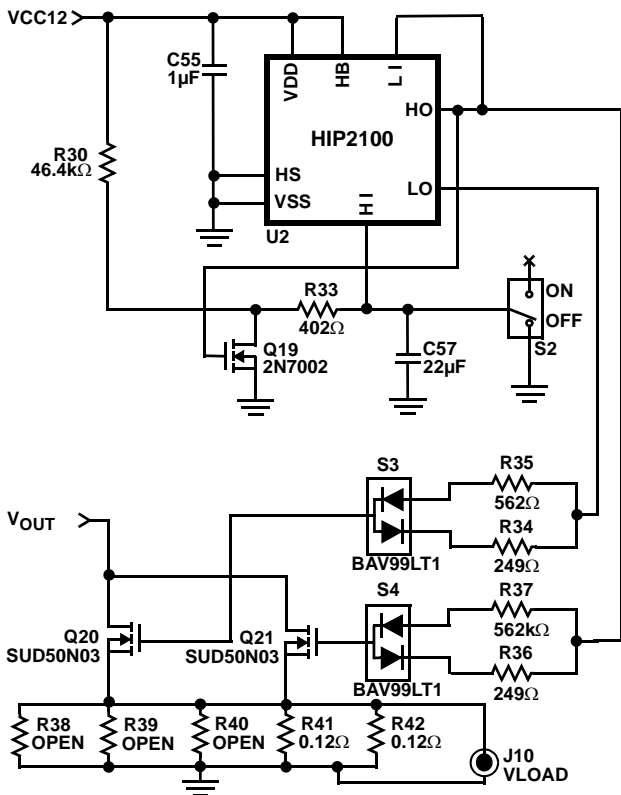

FIGURE 2. LOAD TRANSIENT GENERATOR

Inductor DCR Static Current Sense Points

A unique feature of the ISL6310EVAL1Z is the ability to measure the voltage drop across the DCR of each channel's inductor by multimeter. This is accomplished with the use of a capacitor and resistor series circuit which is placed in parallel across each inductor as illustrated in Figure 3. When

current, I_L , flows through the inductor, the voltage drop developed across the DCR will be sensed by the R-C circuit, and an equivalent voltage will be developed across the capacitor C.

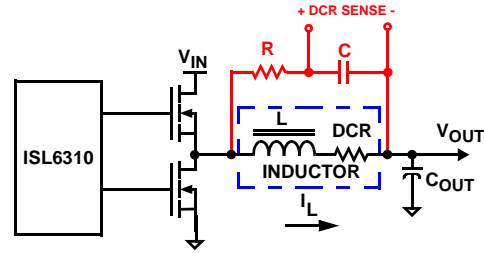

FIGURE 3. DCR STATIC CURRENT SENSE CIRCUIT

In order to not affect the rest of the regulator, the time constant of this R-C circuit is very large, so it can only be used to measure static current, and not transient currents. To calculate the current through each inductor measure the voltage across the “DCR SENSE” points on the ISL6310EVAL1Z and then divide that number by the DCR of the inductor. This should give you an accurate reading of the current through each channel during static loads.

Modifying the ISL6310EVAL1Z Design

Current Balance Resistors

The ISL6310 uses lower MOSFET $r_{DS(ON)}$ current sensing to measure the current through each channel and balance them accordingly. If the lower MOSFETs on the ISL6310EVAL1Z are changed, the current balance resistors, R18 and R20, should also be changed to adjust for the change in $r_{DS(ON)}$. Refer to page 19 in the ISL6310 data sheet to choose new current sense resistors. R18 adjusts the current in channel 1, R20 adjusts the currents in channel 2, These resistors can also be changed to adjust for any current imbalance due to layout, which is also explained on page 19 of the ISL6310 data sheet.

Load Line (Droop) Regulation

The ISL6310 has an optional Droop function, the ISL6310EVAL1Z board design is optimized for no Droop case. For Droop option selection follow the following Table 3.

TABLE 3. SELECTION OF DROOP OPTION

DROOP	R46	R45
Disabled (Droop connected IREF)	0Ω	OPEN
Enabled (Droop connected ICOMP)	OPEN	0Ω

If Droop is implemented, the compensation network will need to be recalculated for the Droop case for optimal loop response and stability.

To create an output voltage change proportional to the total current in all the active channels (droop), the ISL6310 uses

an inductor DCR sensing R-C network. This network, shown in Figure 4, is designed not only to precisely control the load line of the regulator, but also to thermally compensate for any changes in DCR that may skew the load line as a result of increases in temperature.

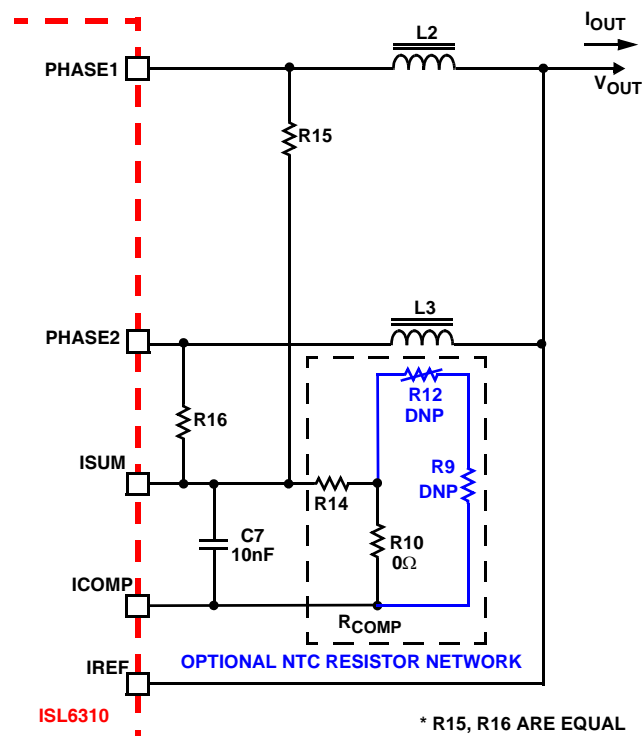

FIGURE 4. DCR SENSING CONFIGURATION WITH OPTIONAL FOOTPRINTS FOR NTC LOAD-LINE COMPENSATION

This sensing technique works off the principle that if the R-C time constant of $C7 \cdot R_{COMP}$ ($R_{COMP} = R14$) is equal to the L/DCR time constant of the inductor, the load line impedance will be equal to $R_{COMP} \cdot DCR / R15$ ($R15$ and $R16$ are equal).

If the load line impedance needs to be changed, all that is required is adjusting the values of $R15$ - $R16$ as explained on page 20 of the ISL6310 data sheet. If the Inductor is changed though, the resistance of time constant matching network will need to be changed. The NTC resistor network must first be adjusted so that the new L/DCR time constant is precisely matched. Refer to page 19 and 20 of the ISL6310 data sheet to design the entire R-C sense network

An Optional NTC resistor network consisting of 3 resistors ($R9$, $R10$, and $R14$) and a single NTC thermistor ($R12$), which is placed close the output inductors. This network is designed to compensate for any change in DCR that occurs due to temperature when the Droop option is used and a tight load-line regulation is required, and keep the time constant of the R-C network equal to that of the inductor L/DCR time constant.

Overcurrent Protection Level

The ISL6310 utilizes a single resistor to set the maximum current level for the IC's overcurrent protection circuitry. Please refer to page 17 of the ISL6310 data sheet, and adjust resistor $R11$ accordingly to set the desired overcurrent trip level.

Output Voltage Offset

The ISL6310 allows a designer to accurately offset the output voltage both negatively and positively. All that is required is a single resistor between the OFS and VCC pins, or the OFS pin and GND. The ISL6310EVAL1Z has both of these resistor options available on the board. To positively offset the output voltage populate resistor $R5$. To negatively offset the output voltage populate resistor $R7$. Please refer to page 13 of the ISL6310 decathlete to accurately calculate these resistor values.

Switching Frequency

The switching frequency of the ISL6310EVAL1Z board is set to an optimal value of 400kHz giving the best efficiency and performance for the given design with $R13 = 60.4k\Omega$. However, the switching frequency can be adjusted anywhere from 80kHz to 1.5MHz per phase. In practice many factors affect the choice of switching frequency among which are efficiency, and gate drive losses (which depend on the MOSFET choice and Gate Driver Voltage). Since the ISL6310 has integrated MOSFET drivers, the driver losses must be taken into account when the switching frequency is chosen. To change the switching frequency refer to page 24 of the ISL6310 data sheet and adjust the value of frequency set resistor, $R13$, accordingly.

MOSFET Gate Drive Voltage (PVCC)

The gate drive bias voltage of the integrated drivers in the ISL6310 can be any voltage between +5V and +12V. This bias voltage is set by connecting the desired voltage to the PVCC pins of the IC. Please refer to page 2 to set the desired gate drive voltage.

Number of Active Phases

The ISL6310 has the option of 1 or 2-phase operation. The ISL6310EVAL1Z is designed to change the number of active phases by simply populating or depopulating one or two resistors, $R26$ and $R29$. Refer to Table 4 for which resistors to populate for 1 or 2-phase operation.

TABLE 4. SETTINGS FOR NUMBER OF ACTIVE PHASES

# OF ACTIVE PHASES	R26	R29
2	0Ω	OPEN
1	OPEN	0Ω

ISL6310 Performance

Soft-Start Interval

The typical start-up waveforms for the ISL6310EVAL1Z are shown in Figure 5. The waveforms represented in this image show the soft-start sequence of the regulator DAC set to 1.50V. Before the soft-start interval begins, VCC and PVCC are above POR and the DAC is set to 11. With these two conditions met, throwing the ENABLE switch into the OFF position causes the voltage on the ENLL pin to rise above the ISL6310's enable threshold, beginning the soft-start sequence. For a delay time of 0.6ms, V_{OUT} does not move due to the manner in which soft-start is implemented within the controller. After this delay (which is approximately equal to 240 switching cycles), V_{OUT} begins to ramp linearly toward the DAC voltage. With the converter running at 400kHz, this ramp takes approximately 4.3ms, during which time the input current, I_{CC12} , also ramps slowly due to the controlled building of the output voltage.

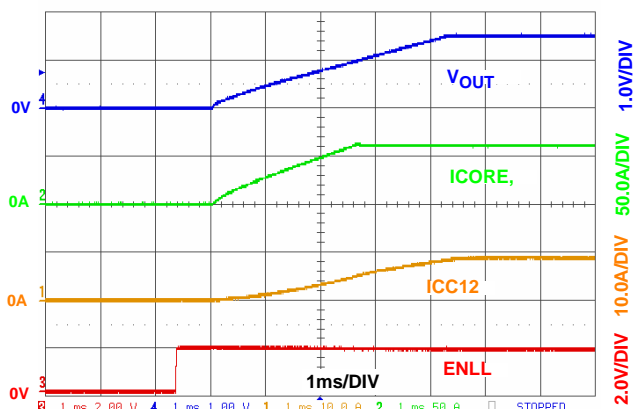

FIGURE 5. SOFT-START INTERVAL WAVEFORMS

Once V_{OUT} reaches the DAC set point, the internal pull-down on the PGOOD pin is released. This allows a resistor from PGOOD to VCC to pull PGOOD high and the PGOOD LED indicator changes from red to green.

Special consideration is given to start-up into a pre-charged output (where the output is not 0V at the time the SS cycle is initiated). Under such circumstances, the ISL6310 keeps off both sets of output MOSFETs until the internal ramp starts to exceed the output voltage sensed at the FB pin. This special scenario is detailed in Figure 6. The circuit is enabled at time T0. As the internal ramp exceeds the magnitude of the output voltage at time T1, the MOSFETs drivers are enabled and the output voltage ramps up in a seamless fashion from the pre-existent level to the DAC-set level, reached at time T2.

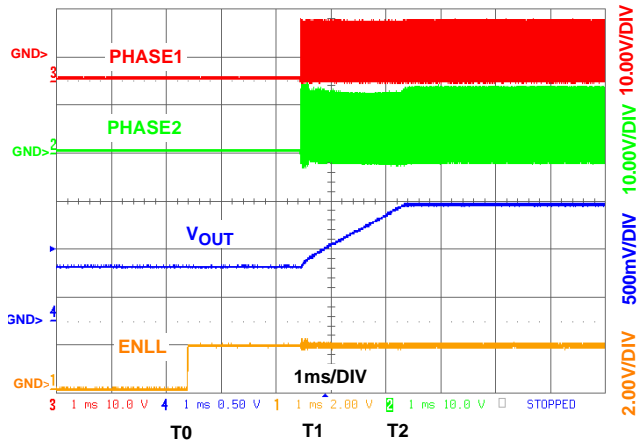

FIGURE 6. ISL6310EVAL1Z START-UP INTO A PARTIALLY CHARGED OUTPUT ($V_{DAC} = 1.200V$)

A second scenario can be encountered with a pre-charged output: output being pre-charged above the DAC-set point, as shown in Figure 7. In this situation, the ISL6310 behaves in a way similar to that of Figure 6, keeping the MOSFETs off until the end of the SS ramp. However, once the end of the ramp has been reached, at time T1, the output drivers are enabled for operation, and the output is quickly drained down to set-point level.

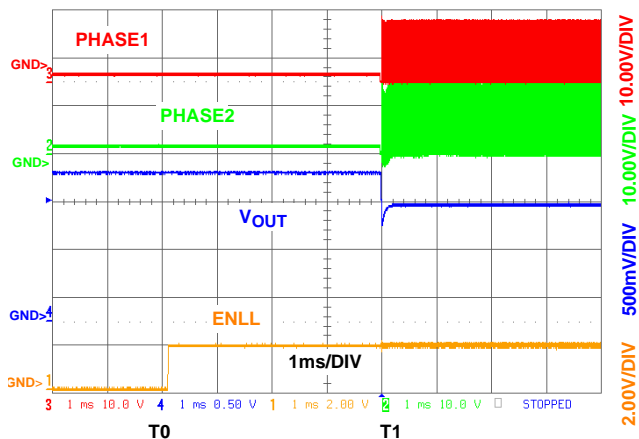

FIGURE 7. ISL6310EVAL1Z START-UP INTO AN OVERCHARGED OUTPUT ($V_{DAC} = 1.200V$)

An OV condition during start-up will take precedence over this normal start-up behavior, but will allow reversal back to normal behavior as soon as the condition is removed or brought under control.

Transient Response

The ISL6310EVAL1Z is designed without droop for a maximum output load current of 60A. The Load step is approximately 25A and the output voltage variation during the transient is kept below 100mV peak to peak. This load step have a maximum slew rate of approximately 50A/μs on both the rising and falling edges. The on-board load transient generator is designed to provide the specified load step, different load steps and current slew rates can be accommodated with the on Board Transient load generator.

The rising edge transient response of the ISL6310EVAL1Z, is shown in Figure 8. In order to obtain the load current waveform shown, the bench-top load is turned off, while the on-board transient generator is pulsing a 25A step for 500μs. When the load step occurs, the output capacitors provide the initial output current, causing V_{OUT} to drop suddenly due to the ESR and ESL voltage drops in the capacitors. The controller immediately responds to this drop by increasing the PWM duty cycles to as much as 66%. The duty cycles then decrease to stabilize V_{OUT} .

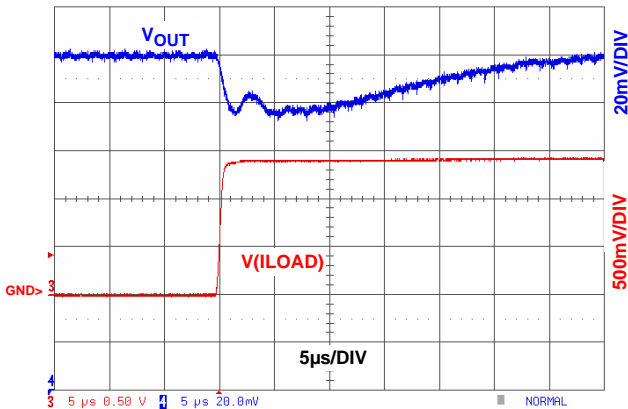

FIGURE 8. ISL6310EVAL1Z RISING EDGE TRANSIENT LOAD RESPONSE

At the end of the 500μs load pulse, the load current returns to 0A. The transient response to this falling edge of the load is shown in Figure 9. When the falling load step occurs, the output capacitors must absorb the inductor current which can not fall at the same rate of the load step. This causes V_{OUT} to rise suddenly due to the ESR and ESL voltage drops in the capacitors. The controller immediately responds to this rise by decreasing the PWM duty cycles to zero, and then increasing them accordingly to regulate V_{CORE} to the programmed 1.5V level.

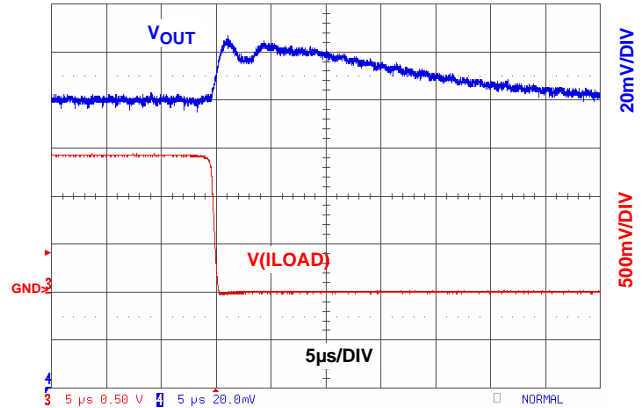

FIGURE 9. ISL6310EVAL1Z FALLING EDGE TRANSIENT RESPONSE

Figure 10 shows both the rising and falling edges.

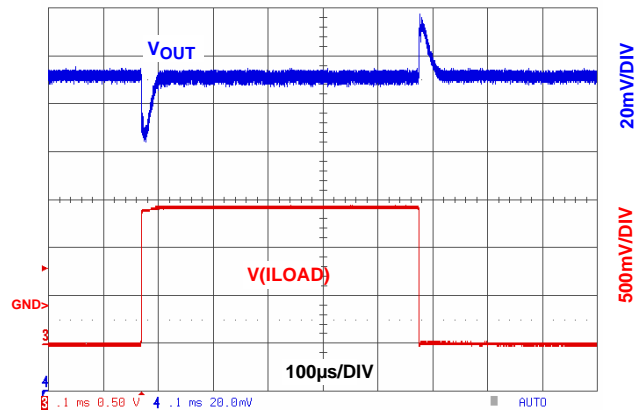

FIGURE 10. ISL6310EVAL1Z TRANSIENT RESPONSE

Overcurrent Protection

The ISL6310 is designed to stop all regulation and protect the sensitive Load if an overcurrent event occurs. This is done by continuously monitoring the total output current and comparing it to an overcurrent trip level set by the OCSET resistor, R11. If the output current ever exceeds the trip level as shown in Figure 11 (at time T1), the ISL6310 immediately turns the upper and lower MOSFETs off, causing V_{OUT} to fall to 0V. The controller holds the UGATE and LGATE signals in this state for a period of 4096 switching cycles, which at 400kHz is 10.25ms. The controller then re-initializes the soft-start cycle (at time T2). If the load that caused the overcurrent trip remains, another overcurrent trip will occur before the soft-start cycle completes. The controller will continue to try to cycle soft-start indefinitely until the load current is reduced, or the controller is disabled. This operation is shown in Figure 11.

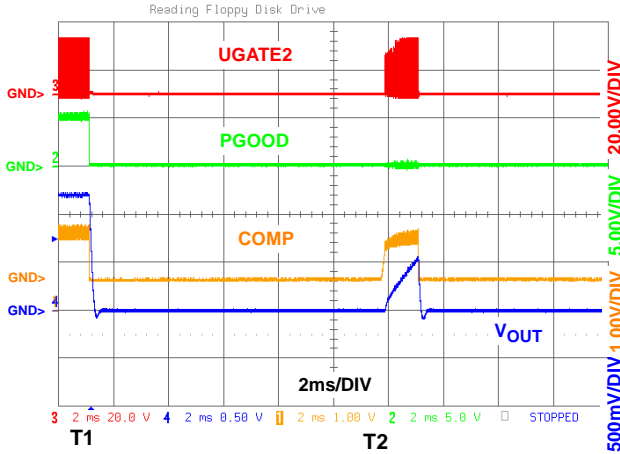

FIGURE 11. ISL6310EVAL1Z OVERCURRENT PROTECTION

Pre-POR Overvoltage Protection

Prior to PVCC and VCC exceeding their POR levels, the ISL6310 is designed to protect the load from any overvoltage events that may occur (such an overvoltage may occur if for example one of the upper MOSFETs was shorted at assembly due to manufacturing defects). This is accomplished by means of an internal 10kΩ resistor tied from PHASE to LGATE, which turns on the lower MOSFET to control the output voltage until the input power supply current limits itself and cuts off. In Figure 12, an artificial pre-POR overvoltage event has been created by shorting the positive 12V input plane to the PHASE plane. This same 12V input is connected to PVCC pins of the ISL6310. Figure 12 illustrates how the controller protects the load from a high output voltage spike, when the 12V input turns on, by tying LGATE to PHASE.

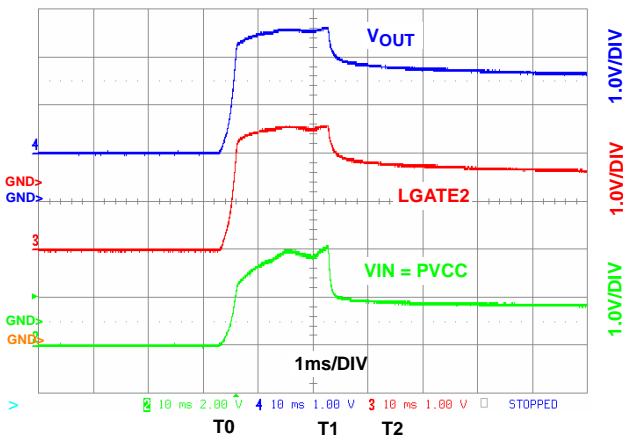

FIGURE 12. ISL6310EVAL1Z PRE-POR OUTPUT OVERVOLTAGE PROTECTION (START-UP WITH SHORTED UPPER FET)

Overvoltage Protection

To protect from an overvoltage event during normal operation, the ISL6310 continually monitors the output voltage. If the output voltage exceeds a specific limit (set internally), the controller commands the LGATE signals high, turning on the lower MOSFETs to keep the output voltage below a level that might cause damage to the Load. As shown in the overvoltage event in Figure 12, turning on the lower MOSFETs not only keeps the output voltage from rising, it also sinks a large amount of current, causing the input voltage to the power stage to drop. If this causes the input power supply voltage to fall below the POR level of the ISL6310, as seen at the end of the waveform in Figure 13, the controller responds by using the pre-POR overvoltage protection explained in the previous section. This allows the ISL6310 to always keep the output load safe from high voltage spikes during an entire overvoltage event.

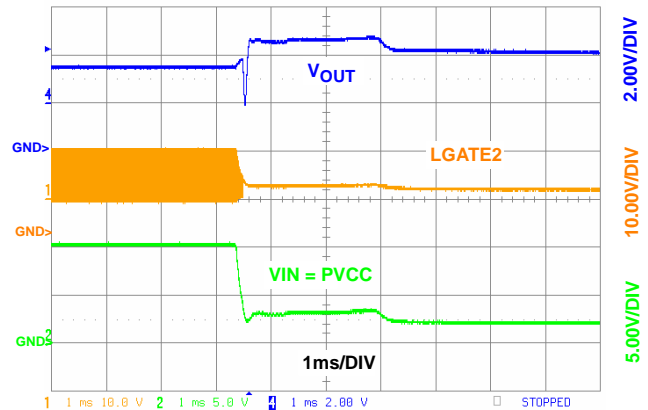

FIGURE 13. ISL6310EVAL1Z PRE-POR OVERVOLTAGE PROTECTION

Efficiency

The efficiency of the ISL6310EVAL1Z board, loaded from 0A to 60A, at both PVCC = 5V and 12V are plotted in Figure 14 for V_{OUT} = 1.5V. Measurements were performed at room temperature and taken at thermal equilibrium without any air flow. The efficiency peaks just below 88% at 35A for the PVCC = 12V case and then levels off steadily to approximately 86% at 60A, while for the PVCC = 5V, efficiency peaks at around 89% at 17A and then falls down to approximately 84% at 60A.

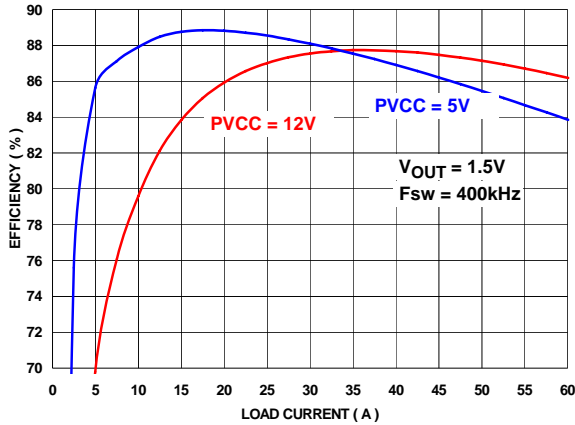

FIGURE 14. EFFICIENCY vs LOAD CURRENT

The efficiency for $V_{OUT} = 1.8V$ is plotted in Figure 15. The efficiency peaks just below 89% at 35A for the $PVCC = 12V$ case and then levels off steadily to approximately 87% at 60A, while for the $PVCC = 5V$, efficiency peaks at around 90% at 20A and then falls down to approximately 86% at 60A. The use of air flow could improve the efficiency across the load range and keeps the components cooler leading to better reliability and longer component lives.

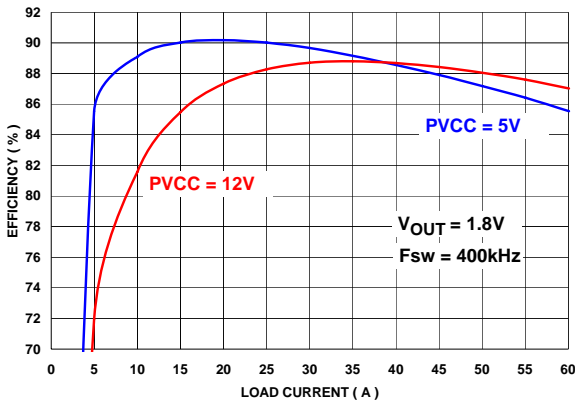

FIGURE 15. EFFICIENCY vs LOAD CURRENT

Modifications

Adjusting the Output Voltage

The output voltage can be adjusted by changing the 2 bit inputs (REF1, REF0) of internal DAC (externally connected with a resistor to REF). Please consult the data sheet for the available voltage ranges and the required settings.

The offset pin (OFS) allows for small-range (less than 100mV), positive or negative, offsetting of the output voltage. The board is shipped with $R90$ equal to 0Ω and $R82$ is not populated to provide an output voltage equal to the internal DAC setting. Should an output voltage setting outside the normal range provided via the internal DAC be required, a separate resistor divider connected from the load output terminals to $VSEN$ pin as shown in Figure 16 is needed.

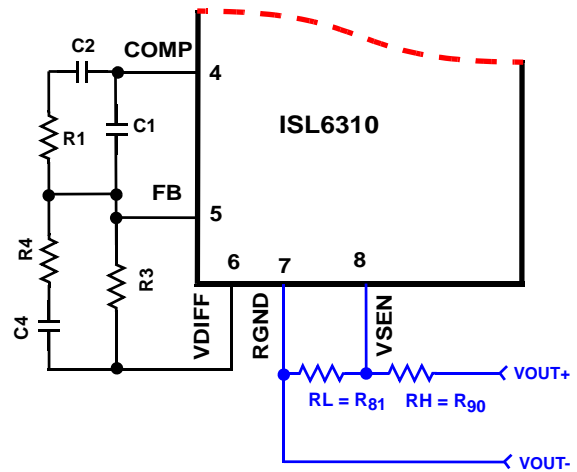

FIGURE 16. ADJUSTING V_{OUT} OUTSIDE THE REF (DAC) RANGE

Use the following relationships to calculate the value of the resistors based on the known parameters.

$$R_L + R_H \leq 500\Omega \quad (\text{EQ. 1})$$

Choose a value for R_L (for example 300Ω)

Choose a value of V_{REF} that meets the following condition

$$V_{REF} \geq V_{OUT} - 0.8V \quad (\text{EQ. 2})$$

Calculate the value of the resistor R_H

$$R_H = \frac{R_L \cdot (V_{OUT} - V_{REF})}{V_{REF}} \quad (\text{EQ. 3})$$

Example:

$$V_{OUT} = 2.1V$$

$$V_{REF} \geq 2.1V - 0.8V \geq 1.3V$$

$$V_{REF} = 1.5V$$

$$R_L = 300\Omega$$

$$R_H = \frac{300\Omega \cdot (2.1V - 1.5V)}{1.5V} = 120\Omega \quad (\text{EQ. 4})$$

Down-Converting From a Different Input Voltage

The ISL6310EVAL1Z is powered from bench supplies, the input labeled '+12V' can be adjusted down as desired. If experimenting with a lower voltage, be mindful of a few aspects:

- The duty cycle of the controller is limited to 66%; the circuit will not be capable of properly regulating the output voltage should the input be reduced to a level low enough to induce duty cycle saturation
- The input-RMS current will likely increase as the input voltage is decreased; maximum will occur at duty cycles around 25% for the two-phase and to 50% for single-phase.
- As the evaluation board (as shipped) was not optimized for high duty cycle operation, closely monitor the board temperatures and increase the output current only as allowed by the board thermal behavior
- The reduced input voltage will decrease the amount of loop gain the modulator provides in the feedback loop, as a result, expect a more sluggish transient response when operating the board at reduced down-conversion voltage
- The Evaluation Board (as shipped) have the +12V is connected as the input to be down-converted and provides gate drive bias (PVCC). Since PVCC can assume any value between +5 and +12V, the Input can be reduced only to 5V. If a lower input voltage is desired, the PVCC voltage should be provided by a separate supply whose value does not drop below +5V. The VCC bias supply can be used in this case (Consult the section entitled "PVCC Power Options" on page 2 for more details on how this can be accomplished)

Summary

The ISL6310EVAL1Z evaluation board showcases a highly integrated approach to providing control in a wide variety of applications. The sophisticated feature set and high-current MOSFET drivers of the ISL6310 yield a highly efficient power conversion solution with a reduced number of external components in a compact footprint. The following pages provide a board schematic, bill of materials and layout drawings to support implementation of this solution. Refer to the ISL6310 data sheet for detailed layout instructions.

References

Intersil documents are available on the web at www.intersil.com.

- [1] ISL6310 Data Sheet, Intersil Corporation, File No. FN9209

ISL6310EVAL1Z Schematic

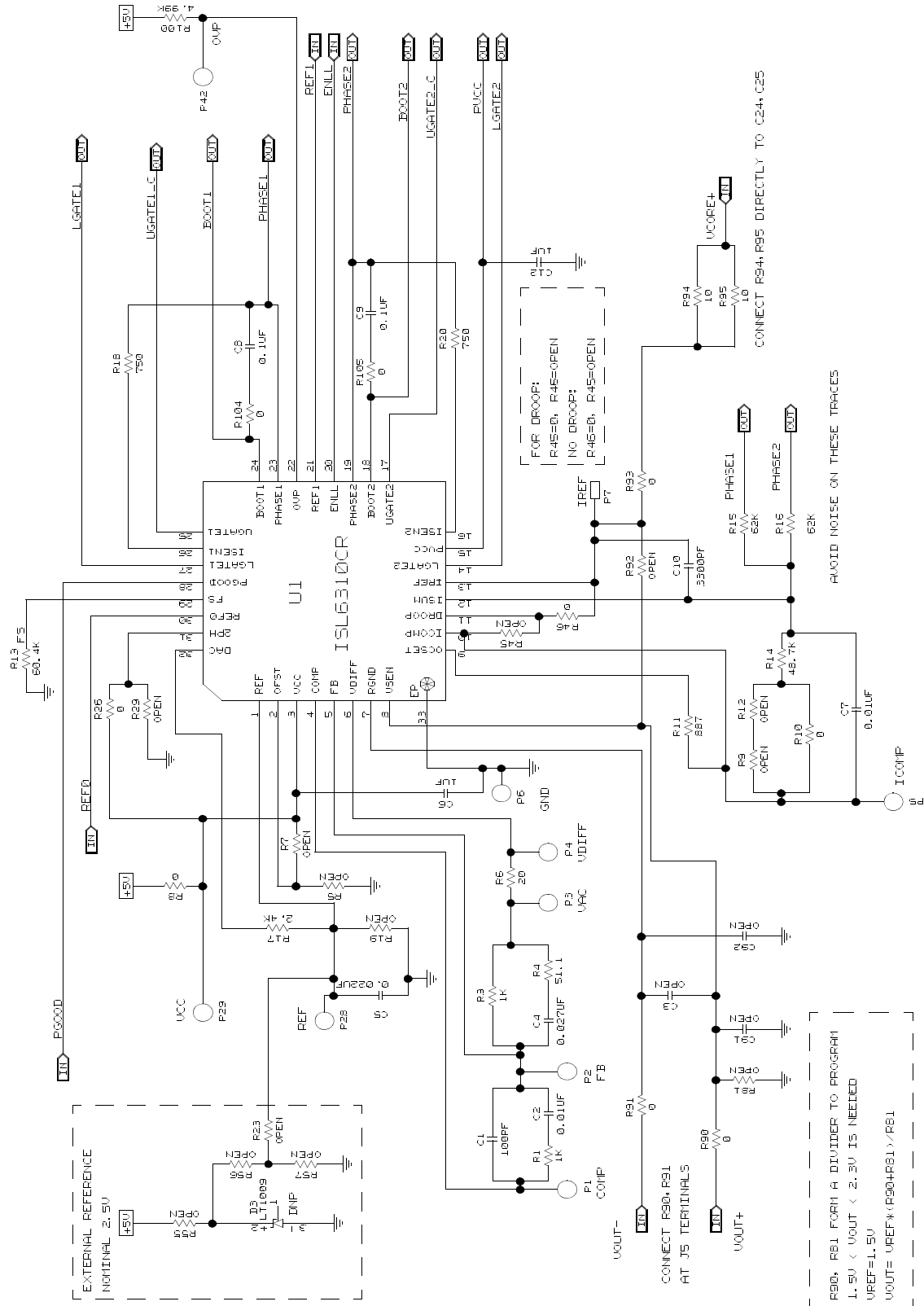

ISL6310EVAL1Z Schematic

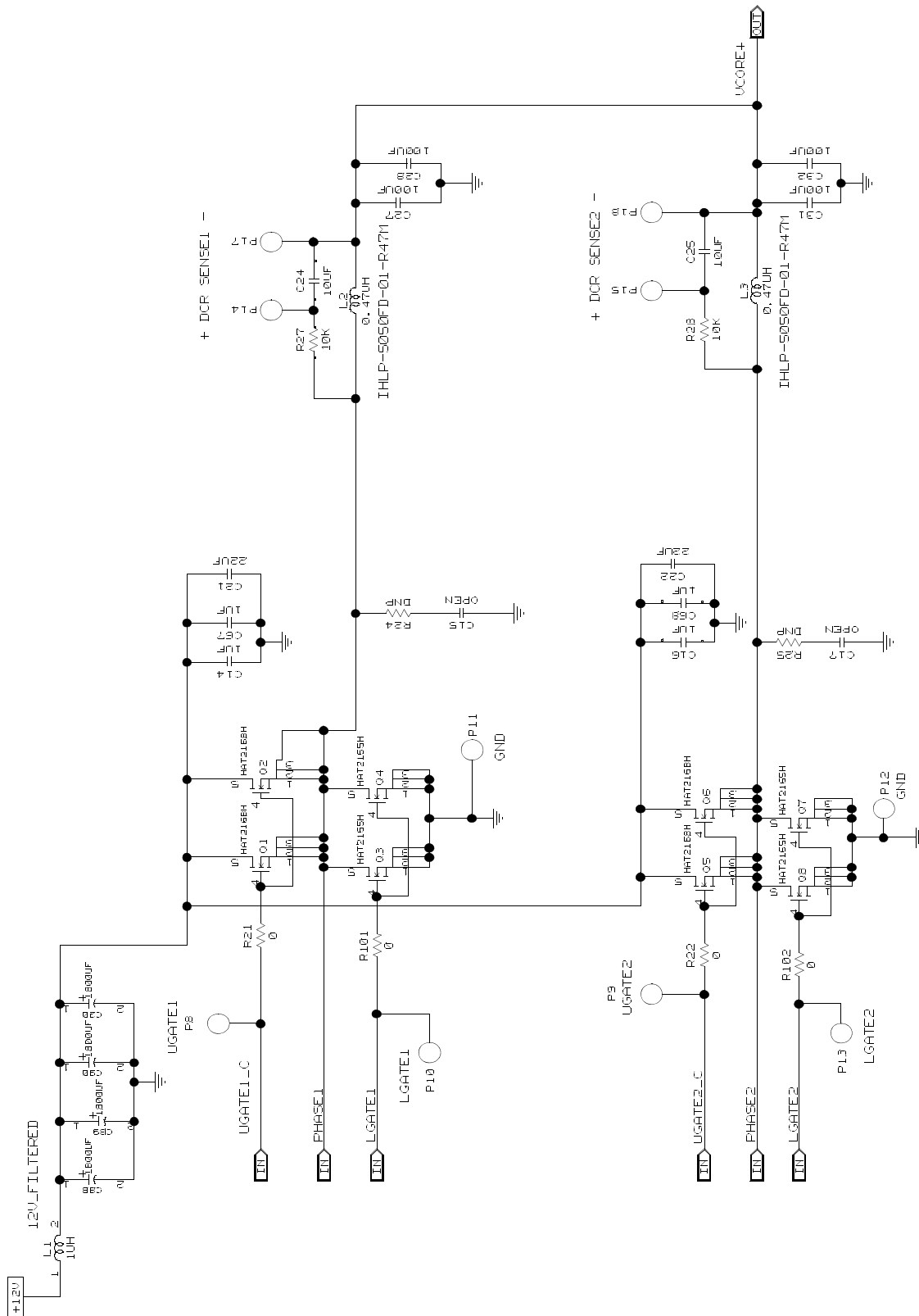

ISL6310EVAL1Z Schematic

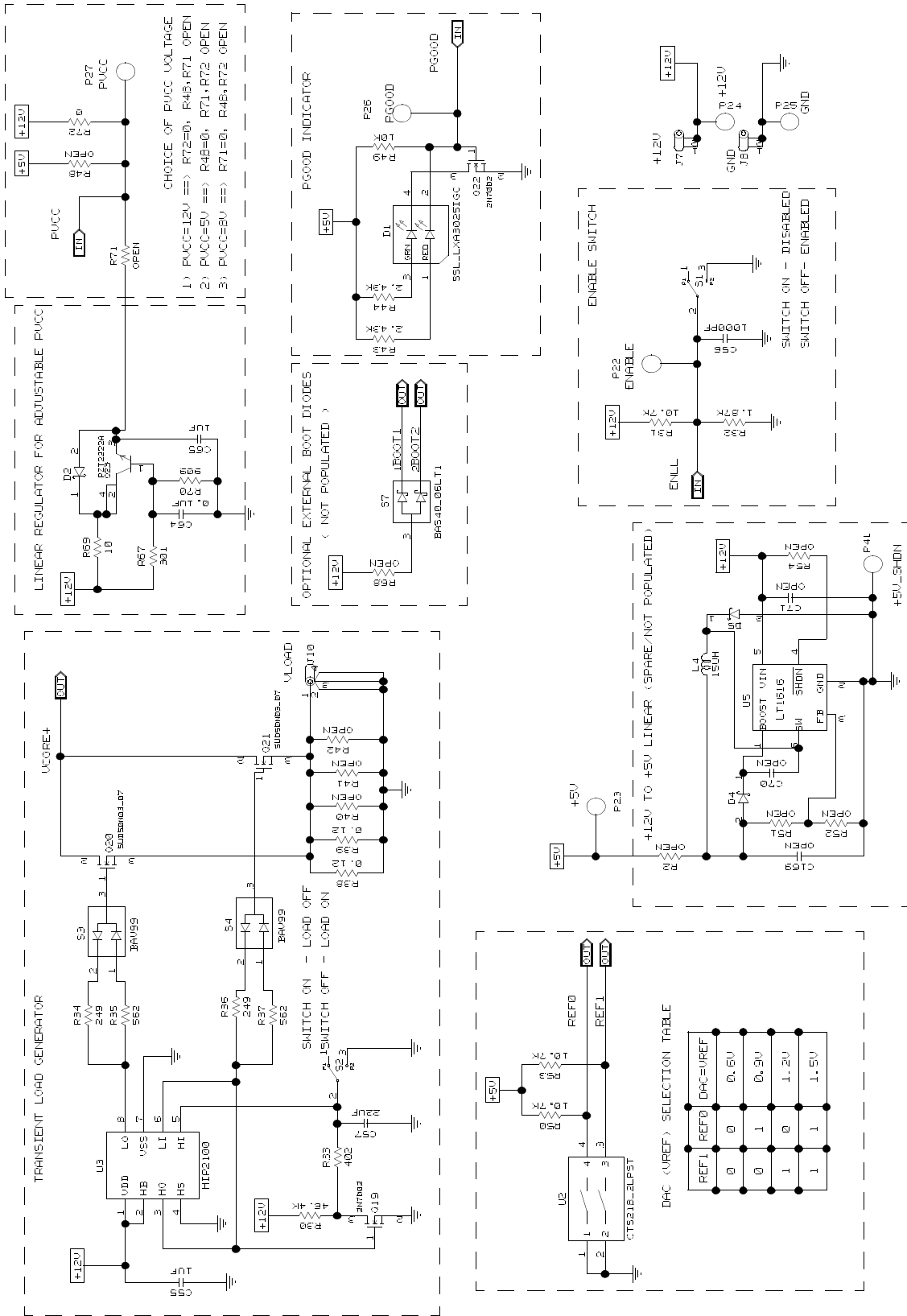

Application Note 1197

Bill of Materials for ISL6310EVAL1Z

REFERENCE DESIGNATOR	PART NUMBER	DESCRIPTION	CASE/ FOOTPRINT	MANUF. OR VENDOR	QTY
C34, 37, 40, 41, 44, 47, 48	4SEPC560M	Capacitor, TH, 8x13mm, 560μF, 4V, 20%, 7mΩ	8x13 mm	Sanyo	7
DNP (C29, 30, 33)	4SEPC560M	Capacitor, TH, 8x13mm, 560μF, 4V, 20%, 7mΩ	8x13 mm	Sanyo	0
C57	C3225X5R1A226M	Ceramic Capacitor, X5R, 10V, 22μF	1210	TDK	1
C56	GRM188R71H102KA ECJ-1VB1H102K C0603X7R500-102KNE	Ceramic Capacitor, X7R, 0603, 50V, 10%, 1000pF	0603	Murata Panasonic Venkel	1
C10	C0603X7R500-332KNE 0603B332K500BT	CAPACITOR, SMD, 0603, 3300pF, 50V, 10%, X7R	0603	Venkel BC Components	1
C4	0.027μF Ceramic Cap	CAPACITOR, SMD, 0603, 0.027μF, 50V, 10%, X7R	0603	Any	1
C1	ECU-V1H101JCG C0805COG500-101JNE	CAPACITOR, SMD, 0805, 100pF, 50V, 5%, NPO	0805	Panasonic Venkel	1
C2, C7	C0805C103K5RACTU 08055C103KAT2A ECJ-2VB1H103K C0805X7R500-103KNE	CAPACITOR, SMD, 0805, 0.01μF, 50V, 10%, X7R	0805	Kemet AVX Panasonic Venkel	2
C8, C9, C64	GRM40X7R104K050AD C0805 1-4K5RAC7800 C0805X74500-104KNE	CAPACITOR, SMD, 0805, 0.1μF, 50V, 10%, X7R	0805	Murata Kemet Venkel	3
C65	C0805X7R160-105KNE C0805C105K4RAC	CAPACITOR, SMD, 0805, 1μF, 16V, 10%, X7R	0805	Venkel Kemet	1
C6, C12	08053D105KAT2A C0805X7R250-105KNE	CAPACITOR, SMD, 0805, 1.0μF, 25V, 10%, X5R	0805	AVX Venkel	2
C5	ECJ-2VB1H223K C0805X7R500-223KNE	CAPACITOR, SMD, 805, 0.022μF, 50V, 10%, X7R	0805	Panasonic Venkel	1
C14, C16, C55, C67, C68.	ECJ-3YB1C105K C1206X7R160-105KNE	CAPACITOR, SMD, 1206, 1μF, 16V, 10%, X7R	1206	Panasonic Venkel	5
C24, C25	C1206X7R100-106KNE	CAPACITOR, SMD, 1206, 10μF, 10V, 10%, X7R	1206	Venkel Any	2
C38, C39, C42, C43, C45, C46, C49-C54, C80- C87	22μF Ceramic	CAPACITOR, SMD, 1206, 22μF, 6.3V, 20%, X5R	1206	Any	20
C27, C28, C31, C32	C3225X5R0J107M ECJ-4YB0J107M 12106D107MAT	CAPACITOR, SMD, 1210, 100μF, 6.3V, 20%, X5R	1210	TDK Panasonic AVX	4
C21, C22	C3225X5R1C226M GRM32ER61C226ME20L	CAPACITOR, SMD, 1210, 22μF, 16V, 20%, X5R	1210	TDK Murata	2
C20, C88-C90	16MBZ1800M10X23	CAP, RADIAL, 10x23, 1800μF, 16V, 20%, AL-UM.ELEC	10x23	Rubycon Panasonic	4
DNP (L4)	1008PS-153K	COIL RF INDUC, SMD, 2.74mm, 15μH, 10%, 0.6A		Coilcraft	0
L2, L3	IHLP-5050FD-01-R47M	COIL-PWR INDUCTOR, SMD, 13mm, 0.47μH, 20%, 55A, SHIELDED		Vishay	2
J5, J10	131-4353-00	CONN-GEN, SCOPE PROBE TEST PT		Tektronix	2
P6, P11, P12, P21, P23- P25, P27, P41	1514-2	CONN-GEN, TERMINAL POST, TH, 0.09		Keystone	9
J8	164-6218	CONN-PLUG, BANA-INSUL-SDRLESS, BLK, 4.23mm		Mouser	1

Application Note 1197

Bill of Materials for ISL6310EVAL1Z (Continued)

REFERENCE DESIGNATOR	PART NUMBER	DESCRIPTION	CASE/ FOOTPRINT	MANUF. OR VENDOR	QTY
J7	164-6219	CONN-PLUG, BANA-INSUL-SDRLESS, RED, 4.23mm, RA		Mouser	1
P1-P5, P7-P10, P13-P15, P17, P18, P20, P22, P26, P28, P29, P42	5002	CONN-GEN, MINI TEST POINT, VERTICAL, WHITE		Mouser	20
S7	BAS40-06LT1-T	DIODE-SCHOTTKY BARRIER, SMD, SOT-23, 3P, 40V		On Semiconductor	1
S3, S4	BAV99TA-T	DIODE-SWITCHING, SMD, SOT23, 70V, 0.2A		Zetex Inc	2
D2	MBR0540T1-T	DIODE-RECTIFIER, SMD, SOD-123, 2P, 40V, 0.5A		On Semiconductor	1
DNP (D4, D5)	MBR0540T1-T	DIODE-RECTIFIER, SMD, SOD-123, 2P, 40V, 0.5A		On Semiconductor	0
D1	SSL-LXA3025IGC-TR	LED, SMD, 3x2.5mm, 4P, RED/GREEN, 12/20MCD, 2V		Lumex	1
L1	T50-8/90-8T-16AWG-1UH	CORE, RADIAL, TH, 1.0μH, T50-8/90, 8TURNS, 16AWG		Any	1
U3	HIP2100IB	IC-HI FREQ BRIDGE DRIVER, 8P, SOIC, 100V		Intersil	1
U1	ISL6310IRZ	IC-2 PHASE PWM CONTROLLER, 32P, QFN, 5X5, Pb-FREE		Intersil	1
Q19, Q22	2N7002-T	TRANSISTOR, N-CHANNEL, 3LD, SOT-23, 60V, 115mA		Any	2
Q23	CZT3019	TRANSISTOR, NPN, 4P, SOT-223, 120V, 1A		Central Semiconductor	1
Q1, Q2, Q5, Q6.	HAT2168H	MOSFET, 30V, 8.8mΩ	LFAK	Renesas	4
Q4, Q3, Q7, Q8.	HAT2165H	MOSFET, 30V, 3.4mΩ	LFAK	Renesas	4
Q20, Q21	SUD50N03-07	TRANSIST-MOS, N-CHANNEL, SMD, TO-252, 30V, 20A	DPAK	Vishay	2
R17	2.4kΩ	Resistor, SMD, 0, 1/16W, 5%	0603	Any	1
R94, R95	10Ω	Resistor, 10Ω, 1/16W, 5%	0603	Any	2
R6	20Ω	Resistor, 20Ω, 1/16W, 5%	0603	Any	1
R10, R26, R46, R90, R91, R93, R104, R105	0Ω	Shorting resistor	0603	Any	7
R1, R3	1kΩ	Resistor, 1kΩ, 1/16W, 1%	0603	Any	2
R27, R28, R49	10kΩ	Resistor, 10kΩ, 1/16W, 1%	0603	Any	3
R31, R50, R53	10.7kΩ	Resistor, 10.7kΩ, 1/16W, 1%	0603	Any	3
R32	1.87kΩ	Resistor, 1.87kΩ, 1/16W, 1%	0603	Any	1
R43, R44	2.43kΩ	Resistor, 2.43kΩ, 1/16W, 1%	0603	Any	1
R34, R36	249Ω	Resistor, 249Ω, 1/16W, 1%	0603	Any	2
R33	402Ω	Resistor, 402Ω, 1/16W, 1%	0603	Any	1
R30	46.4kΩ	Resistor, 46.6kΩ, 1/16W, 1%	0603	Any	1
R14	48.7kΩ	Resistor, 48.7kΩ, 1/16W, 1%	0603	Any	1
R100	4.99kΩ	Resistor, 4.99kΩ, 1/16W, 1%	0603	Any	1
R4	51.1Ω	Resistor, 51.1Ω, 1/16W, 1%	0603	Any	1
R35, R37	562Ω	Resistor, 562Ω, 1/16W, 1%	0603	Any	2

Application Note 1197

Bill of Materials for ISL6310EVAL1Z (Continued)

REFERENCE DESIGNATOR	PART NUMBER	DESCRIPTION	CASE/ FOOTPRINT	MANUF. OR VENDOR	QTY
R13	60.4k Ω	Resistor, 60.4k Ω , 1/16W, 1%	0603	Any	1
R15, R16	62k Ω	Resistor, 62k Ω , 1/16W, 1%	0603	Any	2
R18, R20	750 Ω	Resistor, 750 Ω , 1/16W, 1%	0603	Any	2
R11	887 Ω	Resistor, 887 Ω , 1/16W, 1%	0603	Any	1
R69	10 Ω	Resistor, 10 Ω , 1/10W, 1%	0805	Any	1
R8, R21, R22, R101, R102	0 Ω	Resistor, 0 Ω , 1/10W, 5%	0805	Any	5
R67	301 Ω	Resistor, 301 Ω , 1/10W, 1%	0805	Any	1
R70	909 Ω	Resistor, 909 Ω , 1/16W, 1%	0603	Any	1
R72	0 Ω	Resistor, 0 Ω , 1W, 5%	2512	Any	1
R38, R39	0.12 Ω	Resistor, 0 Ω , 1W, 5%	2512	Any	1
U2	218-2LPST	SWITCH, SMD, 2P, SLIDE, 150M HALFPITCH-GOLD		CTS	1
S1, S2	GT11MSCKE	SWITCH-TOGGLE, SMD, ULTRAMINI, 1P, SPST MINI		C&K	2
J1-J4	KPA8CTP	MTG HDWR, CBL.TERMINAL-LUG&SCREW, 6-14AWG		BERG/FCI	4
C3, C15, C17, C70, C71, C91 C92, C169	DNP				0
R2, R5, R7, R9, R12, R19, R23-R25, R29, R40-R42, R45, R48, R51, R52, R54-R57, R68, R71, R81, R92	DNP				0
DNP (D3)	LT1009CLP	IC-2.5V ADJ. SHUNT REGULATOR, TH, 3P, TO-92	TO-92	TI	0
DNP (U5)	LT1616ES6	IC-SWITCHING REGULATOR, 6P, SOT23, 0.6A	SOT23	Linear Tech	

ISL6310EVAL1Z Layout

TOP SILK SCREEN

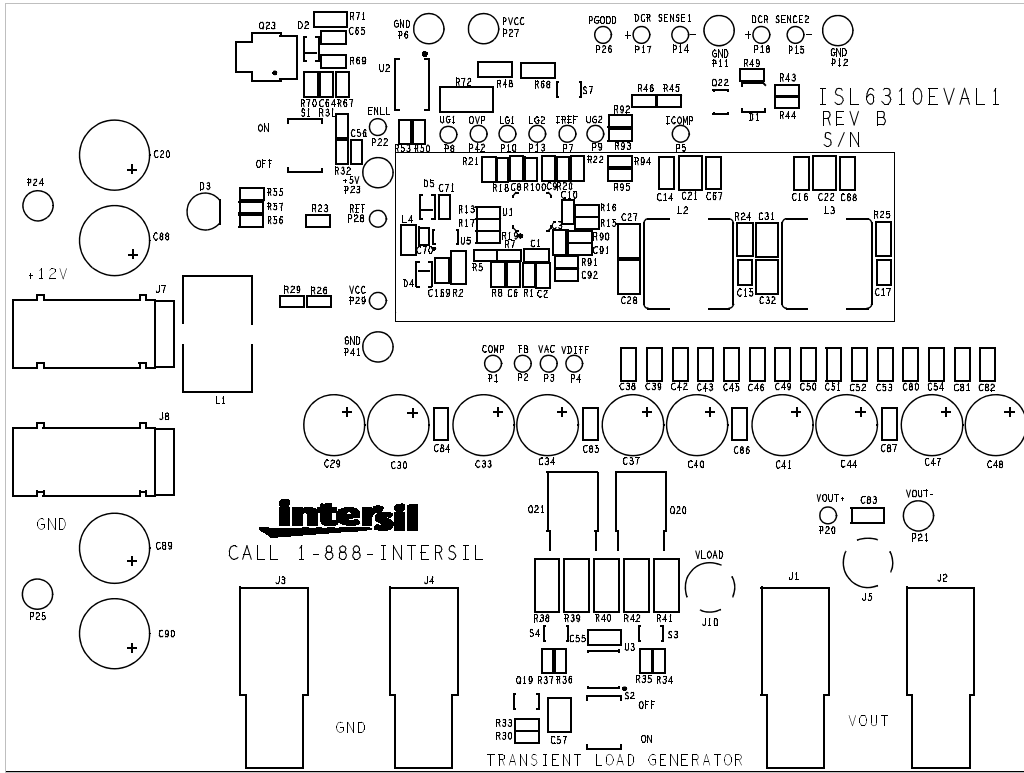

TOP LAYER (1st)

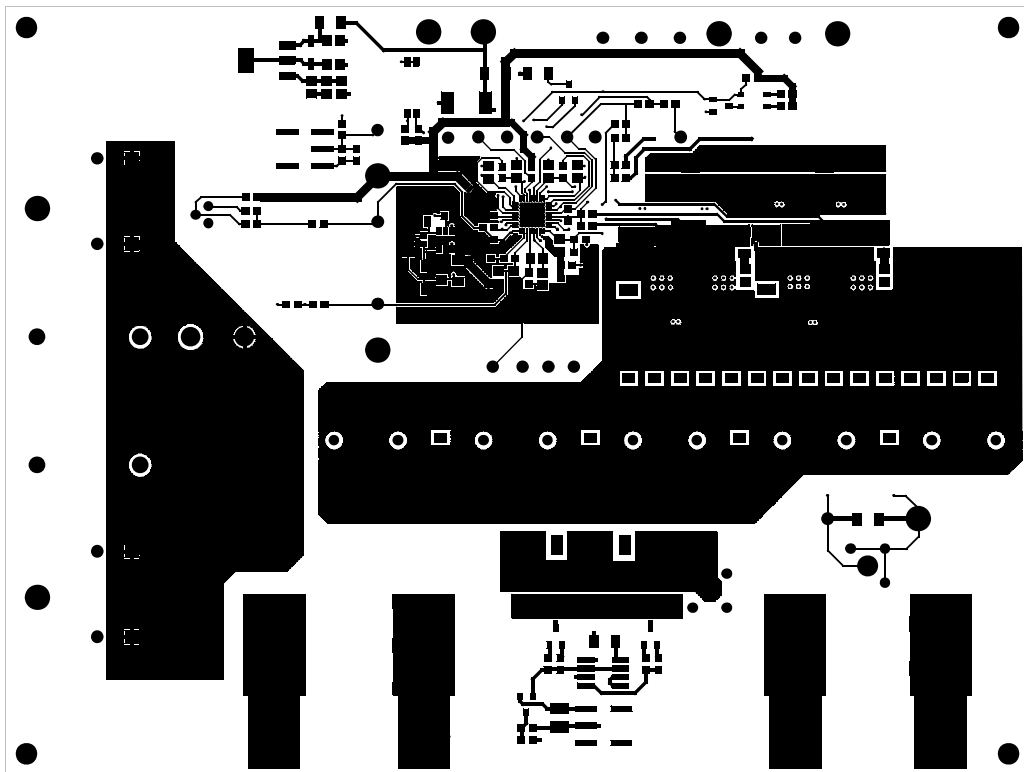

ISL6310EVAL1Z Layout (Continued)

GROUND LAYER (2nd)

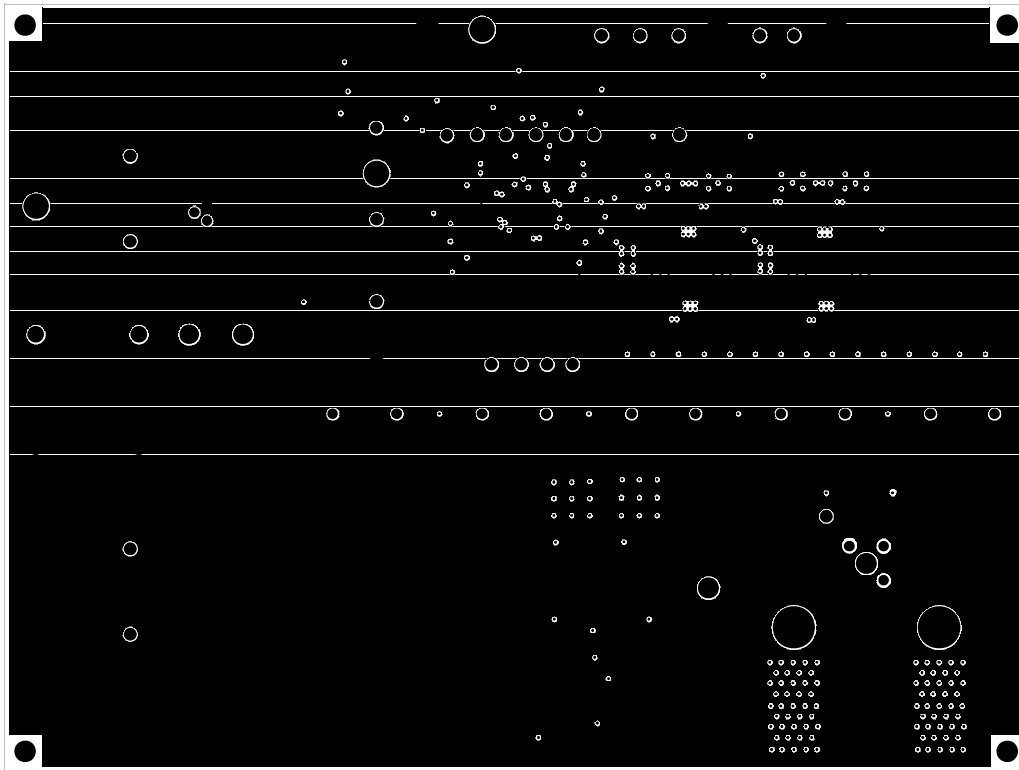

GND/SIGNAL LAYER (3rd)

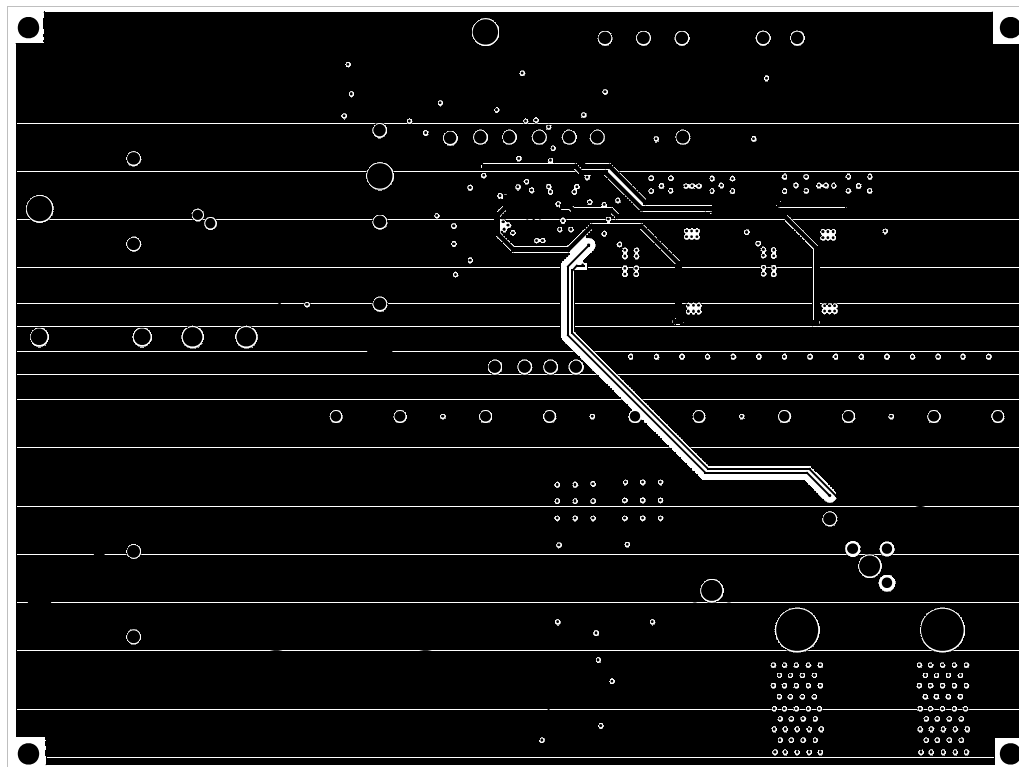

ISL6310EVAL1Z Layout (Continued)

POWER LAYER (4th)

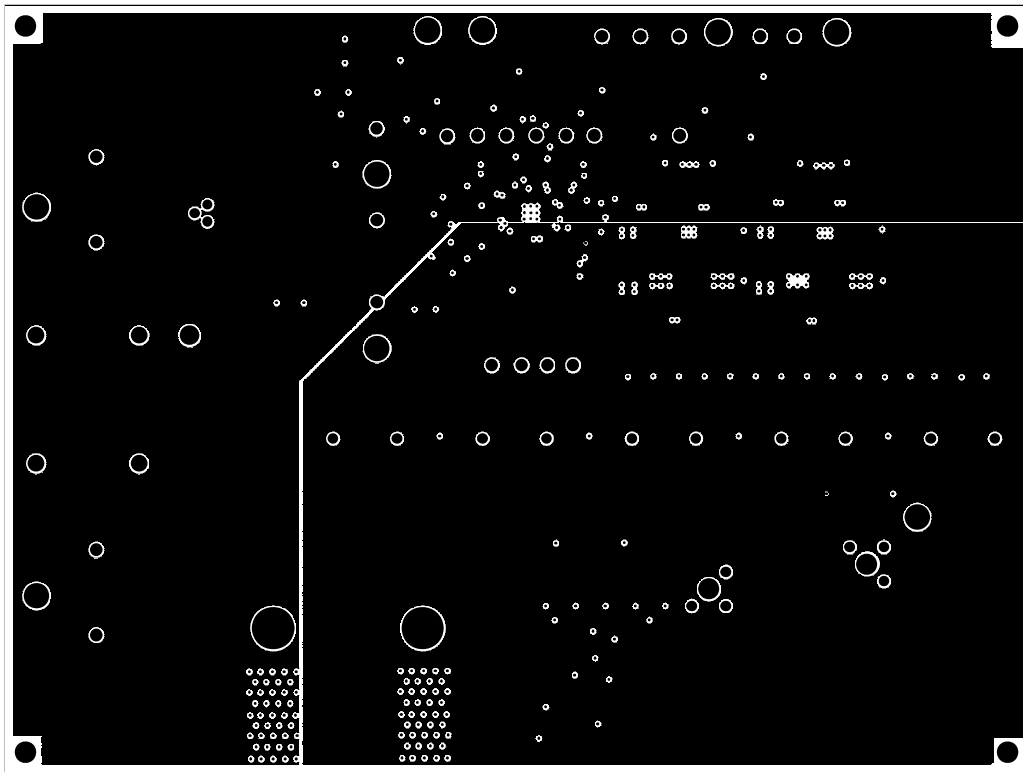

GND LAYER (5th)

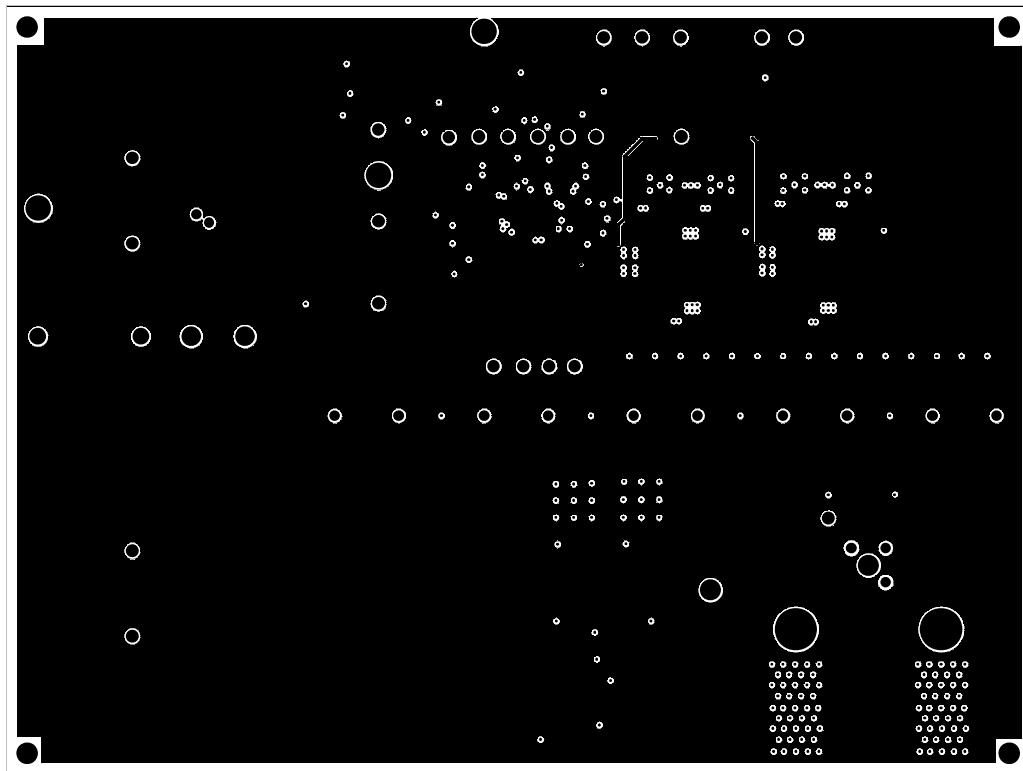

ISL6310EVAL1Z Layout (Continued)

POWER/SIGNAL LAYER (6th)

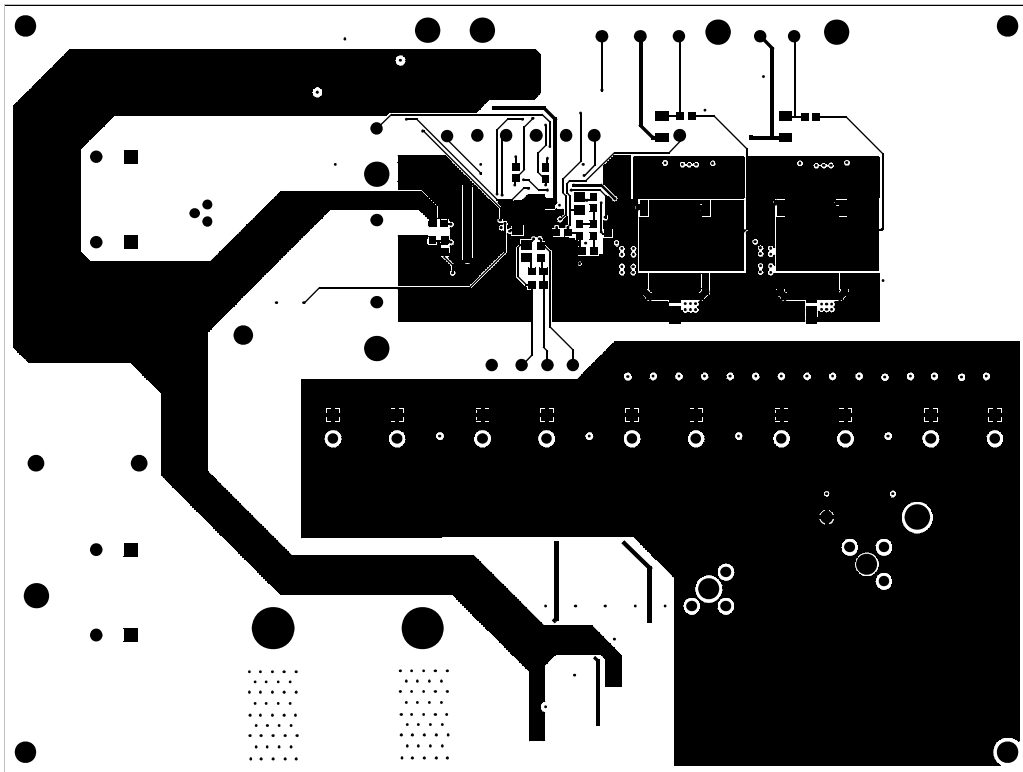

BOTTOM SILK SCREEN

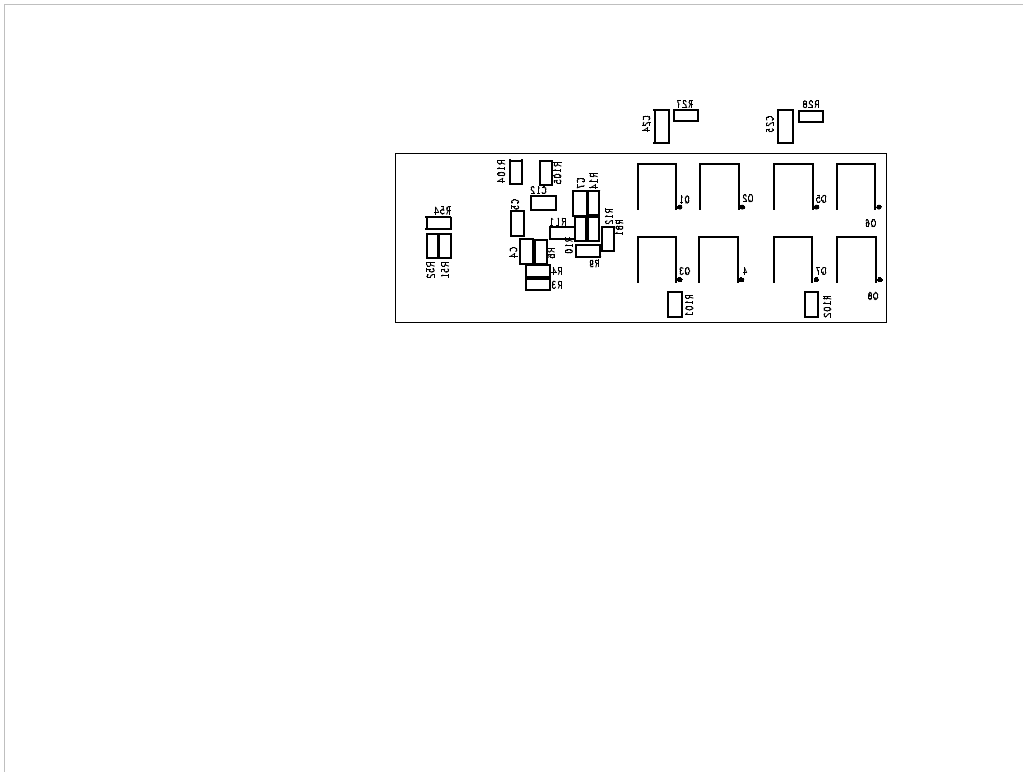

Intersil Corporation reserves the right to make changes in circuit design, software and/or specifications at any time without notice. Accordingly, the reader is cautioned to verify that the Application Note or Technical Brief is current before proceeding.

For information regarding Intersil Corporation and its products, see www.intersil.com