

FEATURES

- ITE (2nd Ed.) and Medical (3rd ed.) MOPP safety approved
- 55-65W compact high density
- 2" x 4" standard footprint
- High efficiency up to 90%
- Remote Sense
- Universal AC input
- Low profile - 1U package
- Convection-cooled operation up to 65W
- Complies with 5000m altitude
- RoHS compliant
- Input power < 74W
- UL Class I and II approved
- Less than 0.3W no load input power
- Complies with ErP/Energy Star requirement excluding 5V output

DESCRIPTION

The MVAD065 series switching power supplies utilize advanced component and circuit technologies to deliver high efficiency. Designed for Medical, Telecom, and Industrial applications to satisfy 1U height design considerations, the MVAD065 Series measures only 2.0" x 4.0" x 1.3". All models offer universal AC input and compliance to worldwide safety and EMC standards.

ORDERING GUIDE

Model Number	Natural Convection Cooling	Main Output (V1)
MVAD065-05	55W	5V
MVAD065-12		12V
MVAD065-18	60W	18V
MVAD065-24		24V
MVAD065-48	65W	48V

INPUT CHARACTERISTICS

Parameter	Conditions	Min.	Typ.	Max.	Units
Input Voltage Operating Range	Single phase	90	120/230	264	Vac
	DC	120		300	Vdc
Input Frequency		47	50/60	63	Hz
Turn-on Input Voltage	Input rising at full load	70		85	Vac
Turn-off Input Voltage	Input falling at full load	70		85	Vac
Input Current	90Vac input, full load			1.4	A
Inrush Current	5V		75		Apk
	Other	At 264Vac, at 25°C cold start	60		

OUTPUT CHARACTERISTICS

Model Number	Main Output Voltage (V1)	Load Current	Load Capacitance	Line, Load, Cross Regulation	Typical Efficiency @230Vac full load
MVAD065-05	5V	0 to 11A	0 to 2200µF	± 2%	84%
MVAD065-12	12V	0 to 5.0A	0 to 1000µF	± 2%	88%
MVAD065-18	18V	0 to 3.34A	0 to 680µF	± 2%	86%
MVAD065-24	24V	0 to 2.71A	0 to 560µF	± 2%	89%
MVAD065-48	48V	0 to 1.36A	0 to 330µF	± 2%	90%

MAIN OUTPUT CHARACTERISTICS

Parameter	Conditions	Min.	Max.		Units
			5V	Other	
Transient Response	50% load step, 1A/µsec slew rate		±5		%
Settling Time to 1% of Nominal			500	200	µsec
Turn On Delay	After application of input power		1		sec
Output Voltage Rise	Monotonic, 0 to 100% load		50		msec
Setpoint Accuracy	120Vac, 40W, 25°C		±1	±0.5	%
Output Holdup	115Vac, 100% load	10			msec
Temperature Coefficient			0.02		%/°C
Ripple Voltage & Noise ¹			2	1	%
Remote Sense ³	Compensates for up to 400mV of lead drop with remote sense connected. Protected against short circuit and reverse connection.		400		mV

1. Ripple and noise are measured with 0.1 uF of ceramic capacitance and 47 uF of electrolytic capacitance on each of the power supply outputs. The output noise requirements apply over a 0 Hz to 20 MHz bandwidth. A short coaxial cable with 50ohm scope termination is used.
2. Unless otherwise specified all readings are taken at 120Vac input and 25°C ambient temperature.
3. 0.4V lead drop is compensated in remote sense.



Available now at <http://power.murata.com/acdc3d>



ENVIRONMENTAL CHARACTERISTICS					
Parameter	Conditions	Min.	Typ.	Max.	Units
Storage Temperature Range		-40		85	°C
Operating Temperature Range	See thermal derating curves	-10		70	
	Start up	-20			
Operating Humidity	Non-condensing	10		95	%
Operating Altitude	For Class I ITE Equipment deployment	-200		5000	m
	Other	-200		2000	
MTBF	Telcordia SR-332 M1C3 25°C	1M			Hours
Shock	Operating, IEC60068-2-27, half-sine 5G, 6ms, 3 times per face, 6 faces	Complies			
	Non-operating, IEC60068-2-27, half-sine, 30G, 18ms, 3 times per face, 6 faces	Complies			
Vibration	Operating, IEC60068-2-6, 1.0G, 10-150Hz, 10 minutes per axis, on all 3 axes	Complies			
	Non-operating, IEC60068-2-6, 2.0G, 10-150Hz, 10 minutes per axis, on all 3 axes	Complies			
Safety	IEC60950-1:2005 (2nd Edition); Am1:2009 UL60950-1 2nd Edition,2011-12-19, CSA C22.2 No. 60950-1-07, 2nd Edition,2011-12 EN60950-1:2006 + A11:2009 + A1:2010 + A12:2011 IEC60601-1:2005 + CORR.1(2006) + CORR.2(2007) ANSI/AAMI ES60601-1 (2005+C1:09 + A2:10), CSA-C22.2 No. 60601-1(2008), MOPP CE Marking per LVD				
Warranty	2 years				
Outside Dimensions	2.0" x 4.0" x 1.3" (50.8mm x 101.6mm x 33.02mm)				
Weight	MVAD065-05 / MVAD065-18	0.285lbs (130g) typical			
	Other	0.27lbs (123g) typical			

PROTECTION CHARACTERISTICS						
Parameter	Conditions	Min.	Typ.	Max.	Units	
Overvoltage Protection	MVAD065-05	Latching (50% load)	110		190	%V1
	Other	Latching (60% load)	110		160	
Overcurrent Protection	Hiccup mode		110		160	%A

ISOLATION CHARACTERISTICS					
Parameter	Conditions	Min.	Typ.	Max.	Units
Isolation	Primary to Earth Ground (1xMOPP)	1500			Vac
	Primary to Secondary (2xMOPP) ⁴	4000			
	Secondary to Earth Ground	500			Vdc
Leakage Current (under normal conditions)	240Vac, 60Hz, 25°C			300	µA
	264Vac, 60Hz, 25°C			350	
Touch Current	264Vac, 60Hz, 25°C			100	

EMISSIONS AND IMMUNITY		
Characteristic	Standard	Compliance
Input Current Harmonics	IEC/EN 61000-3-2	Class A
Voltage Fluctuation and Flicker	IEC/EN 61000-3-3	Complies
Conducted Emissions	EN 55022	Class B, Class A (at Class II equipment)
	FCC Part 15	Class B, Class A (at Class II equipment)
ESD Immunity	IEC/EN 61000-4-2	Level 4, Criterion A
Radiated Field Immunity	IEC/EN 61000-4-3	Level 2, Criterion A
Electrical Fast Transient Immunity	IEC/EN 61000-4-4	Level 3, Criterion A
Surge Immunity	IEC/EN 61000-4-5	Level 4, Criterion A
RF Conducted Immunity	IEC/EN 61000-4-6	Level 2, Criterion A
Magnetic Field Immunity	IEC/EN 61000-4-8	Level 2, Criterion A
Voltage dips, interruptions	IEC/EN 61000-4-11	Level 3, Criterion B

4. At class I equipment.

EMI CONSIDERATIONS

For optimum EMI performance, the power supply should be mounted to a metal plate grounded to all 4 mounting holes of the power supply. To comply with safety standards, this plate must be properly grounded to protective earth (see mechanical dimension notes). Pre-compliance testing has shown the stand-alone power supply to comply with EN55022 class A radiated emissions. Radiated emission results vary with system enclosure and cable routing paths.

SAFETY CONSIDERATIONS



1. This power supply is a component level power supply intended for use in class I or class II applications. Secondary ground traces need to be suitably isolated from primary ground traces when used in class II applications.
2. When the power supply is used in class II equipment, all ground traces and components connected to the primary side are considered primary for spacing and insulation considerations.
3. Double pole/neutral fusing.

PERFORMANCE DATA

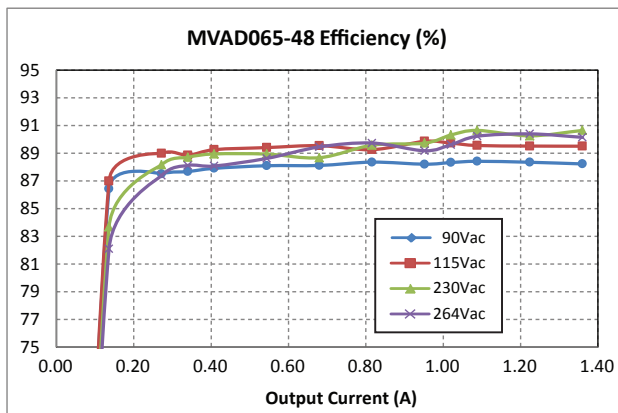
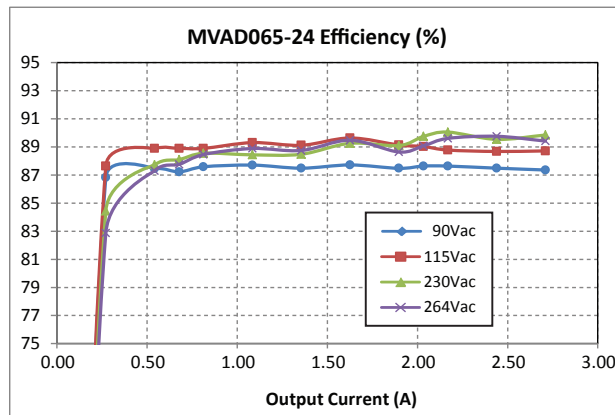
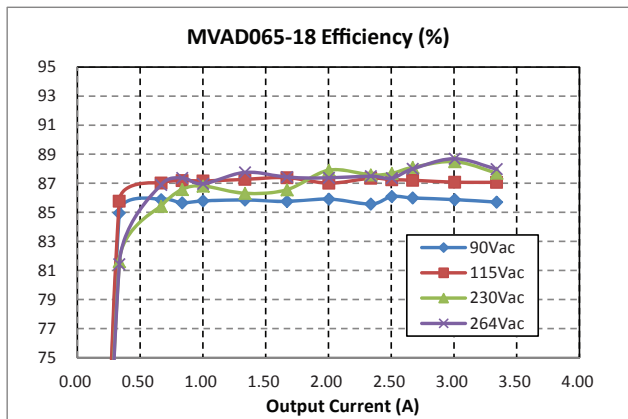
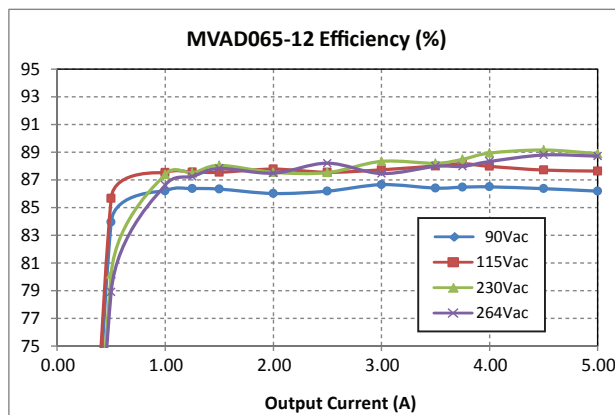
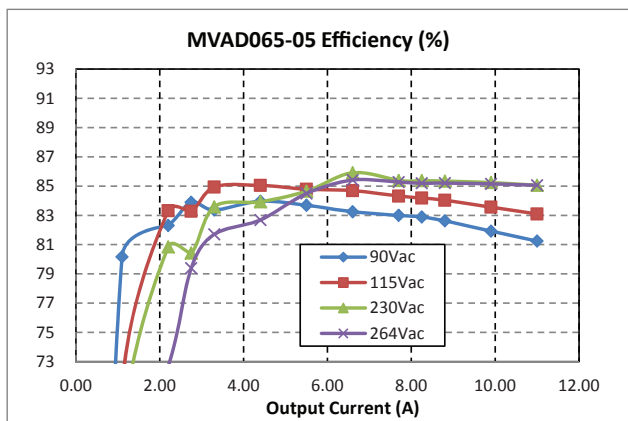

PERFORMANCE DATA

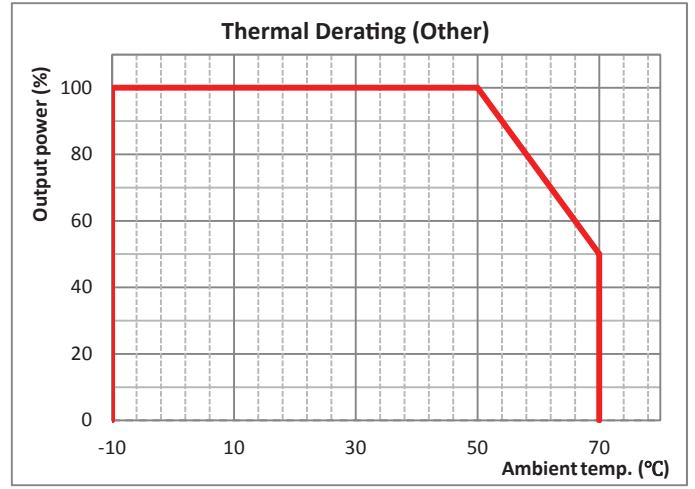
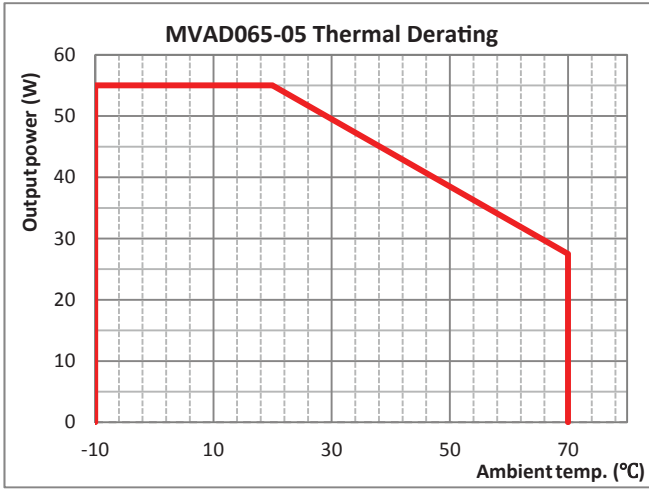

Inrush waveform (AC264V 25°C)

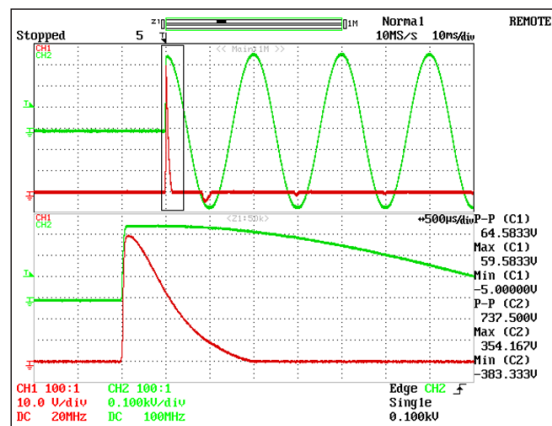

MECHANICAL DIMENSIONS – MVAD065-05 ONLY

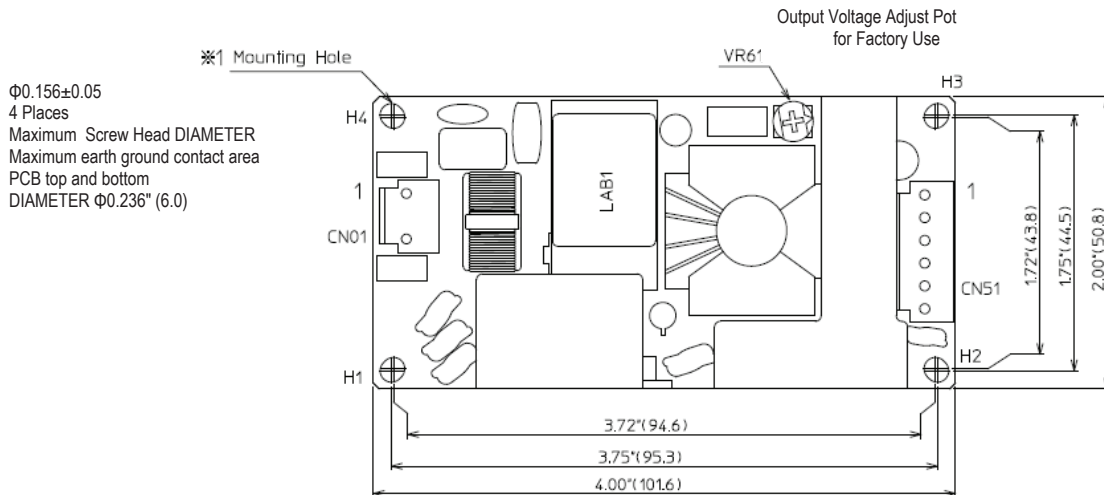

Φ0.156±0.05
4 Places
Maximum Screw Head DIAMETER
Maximum earth ground contact area
PCB top and bottom
DIAMETER Φ0.236" (6.0)

※1 Preferred screw type
M3 (Metric screw threads)
No.4-40UNC (United thread Standard)

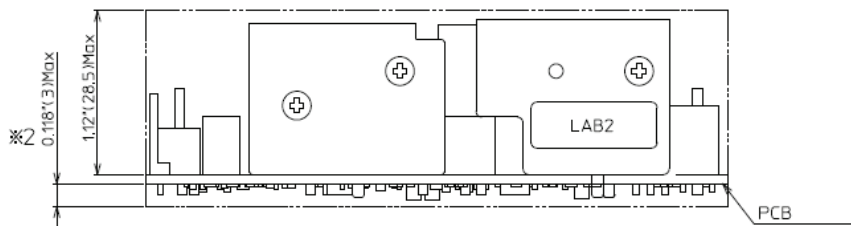

※2 Primary side : 0.106" (2.7) Max
Secondary side : 0.118" (3) Max

All dimensions in inches (mm), tolerance is +/-0.02' (0.5)
Mounting holes H1 and H2 should be earth-grounded for EMI purpose
Mounting holes H2 is earth ground connection
This power supply requires mounting on standoffs minimum 0.2" (5.0) in height

Dimensions: 2.0" x 4.0" x 1.3" (50.8mm x 101.6mm x 33.02mm)

INPUT/OUTPUT CONNECTOR AND SIGNAL SPECIFICATION AND MATING CONNECTORS

PIN	Description	Mating Housing	Crimp terminal/pins
Input Connector CN1 : Molex 26-62-4030			
1	AC Line (V-)	Molex 09-50-8031 with locking ramp	Molex 6838 Series
3	AC Neutral (V+)		
Spade Connector: #250			
GND	Earth Ground		
Output Connector CN2 : Molex 26-60-4060			
1, 2	V1	Molex 09-50-8061 with locking ramp	Molex 6838 Series
3, 4	DC Return		
5	-Remote Sense (NC)		
6	+Remote Sense		

MECHANICAL DIMENSIONS – MVAD065-12x ONLY

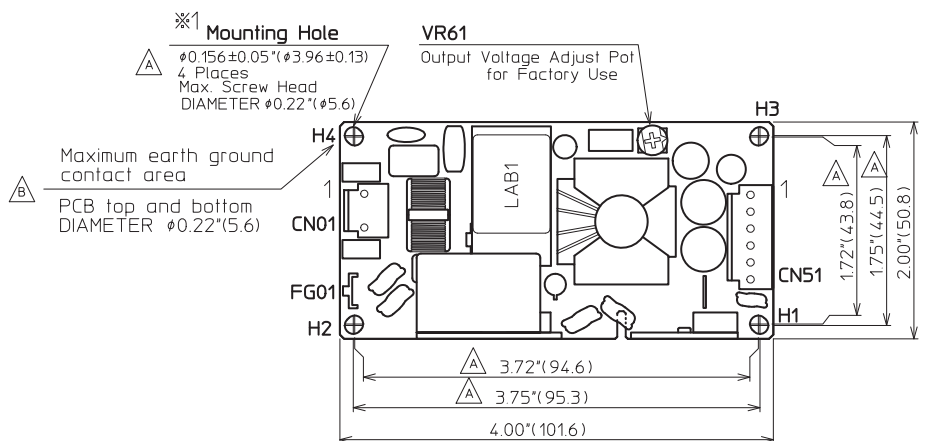

※1 Preferred screw type :
 M3 (Metric screw threads)
 No.4-40UNC (Unified Thread Standard)

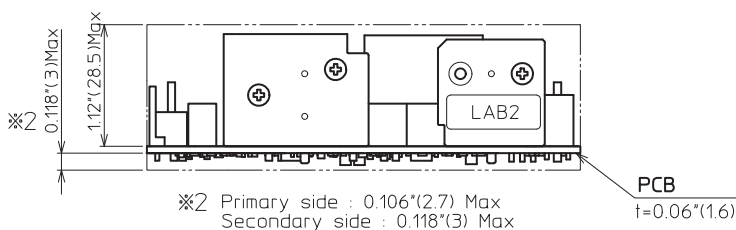

All dimensions in inches (mm), tolerance is ± 0.02 (0.5)
 Mounting holes H1 and H2 should be earth-grounded for EMI purpose
 Mounting holes H2 is earth ground connection
 This power supply requires mounting on standoffs minimum 0.2" (5.0) in height

Dimensions: 2.0" x 4.0" x 1.3" (50.8mm x 101.6mm x 33.02mm)

INPUT/OUTPUT CONNECTOR AND SIGNAL SPECIFICATION AND MATING CONNECTORS

PIN	Description	Mating Housing	Crimp terminal/pins
Input Connector CN1 : Molex 26-62-4030			
1	AC Line (V-)	Molex 09-50-8031 with locking ramp	Molex 6838 Series
3	AC Neutral (V+)		
Spade Connector: #250			
GND	Earth Ground		
Output Connector CN2 : Molex 26-60-4060			
1, 2	V1	Molex 09-50-8061 with locking ramp	Molex 6838 Series
3, 4	DC Return		
5	-Remote Sense (NC)		
6	+Remote Sense		

MECHANICAL DIMENSIONS – MVAD065-xx 24V and 48V MODELS

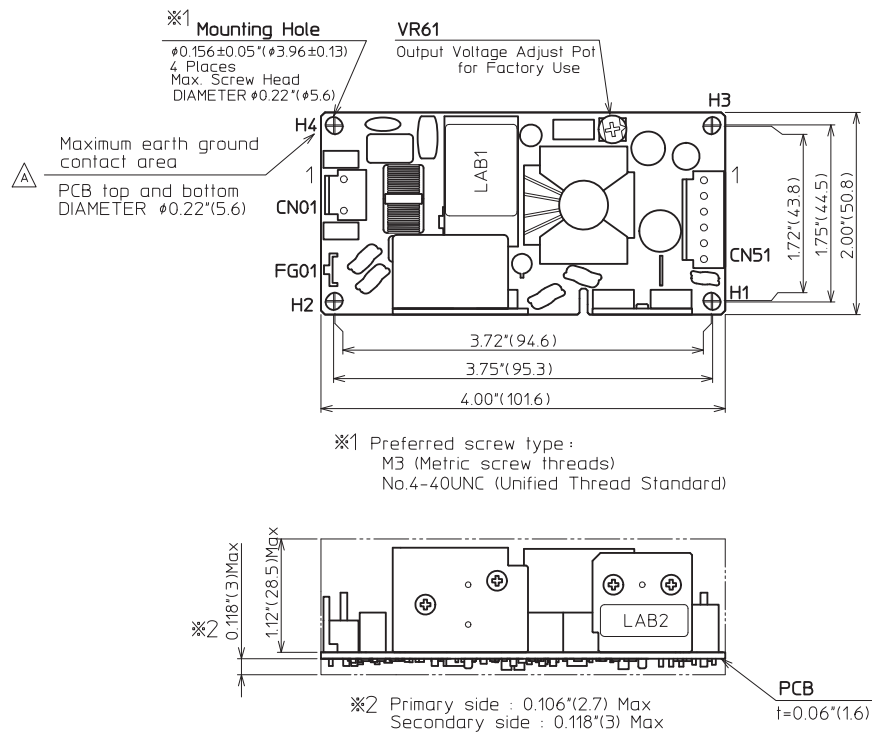

All dimensions in inches (mm), tolerance is ± 0.02 (0.5)
 Mounting holes H1 and H2 should be earth-grounded for EMI purpose
 Mounting holes H2 is earth ground connection
 This power supply requires mounting on standoffs minimum 0.2" (5.0) in height

Dimensions: 2.0" x 4.0" x 1.3" (50.8mm x 101.6mm x 33.02mm)

INPUT/OUTPUT CONNECTOR AND SIGNAL SPECIFICATION AND MATING CONNECTORS

PIN	Description	Mating Housing	Crimp terminal/pins
Input Connector CN1 : Molex 26-62-4030			
1	AC Line (V-)	Molex 09-50-8031 with locking ramp	Molex 6838 Series
3	AC Neutral (V+)		
Spade Connector: #250			
GND	Earth Ground		
Output Connector CN2 : Molex 26-60-4060			
1, 2	V1	Molex 09-50-8061 with locking ramp	Molex 6838 Series
3, 4	DC Return		
5	-Remote Sense (NC)		
6	+Remote Sense		

Murata Manufacturing Co., Ltd. Power Device Product Division
 Nagaokakyo-shi, Kyoto 617-8555 Japan
 ISO 9001 and 14001 REGISTERED



This product is subject to operating requirements and the Life and Safety Critical Application Policy. Click [here](#) to view policy.
Please contact us regarding restricted materials compliance beyond the RoHS directive.

Murata makes no representation that the use of its products in the circuits described herein, or the use of other technical information contained herein, will not infringe upon existing or future patent rights. The descriptions contained herein do not imply the granting of licenses to make, use, or sell equipment constructed in accordance therewith. Buyer represents and agrees that it has all the necessary expertise to create and implement safeguards that anticipate dangerous consequences of failures, monitor failures and their consequences, lessen the likelihood of failures that might cause harm, and take appropriate remedial actions. Buyer will fully indemnify Murata, its affiliated companies, and its representatives against any damages arising out of the use of any Murata products in safety-critical applications. Specifications are subject to change without notice.

© 2015 Murata Manufacturing Co., Ltd. All Rights Reserved.